



ONC+ Developer's Guide

Sun Microsystems, Inc.
901 San Antonio Road
Palo Alto, CA 94303-4900
U.S.A.

Part Number 805-7224-10
February 2000

Copyright 2000 Sun Microsystems, Inc. 901 San Antonio Road, Palo Alto, California 94303-4900 U.S.A. All rights reserved.

This product or document is protected by copyright and distributed under licenses restricting its use, copying, distribution, and decompilation. No part of this product or document may be reproduced in any form by any means without prior written authorization of Sun and its licensors, if any. Third-party software, including font technology, is copyrighted and licensed from Sun suppliers.

Parts of the product may be derived from Berkeley BSD systems, licensed from the University of California. UNIX is a registered trademark in the U.S. and other countries, exclusively licensed through X/Open Company, Ltd.

Sun, Sun Microsystems, the Sun logo, docs.sun.com, AnswerBook, AnswerBook2, and Solaris are trademarks, registered trademarks, or service marks of Sun Microsystems, Inc. in the U.S. and other countries. All SPARC trademarks are used under license and are trademarks or registered trademarks of SPARC International, Inc. in the U.S. and other countries. Products bearing SPARC trademarks are based upon an architecture developed by Sun Microsystems, Inc.

The OPEN LOOK and Sun™ Graphical User Interface was developed by Sun Microsystems, Inc. for its users and licensees. Sun acknowledges the pioneering efforts of Xerox in researching and developing the concept of visual or graphical user interfaces for the computer industry. Sun holds a non-exclusive license from Xerox to the Xerox Graphical User Interface, which license also covers Sun's licensees who implement OPEN LOOK GUIs and otherwise comply with Sun's written license agreements.

RESTRICTED RIGHTS: Use, duplication, or disclosure by the U.S. Government is subject to restrictions of FAR 52.227-14(g)(2)(6/87) and FAR 52.227-19(6/87), or DFAR 252.227-7015(b)(6/95) and DFAR 227.7202-3(a).

DOCUMENTATION IS PROVIDED "AS IS" AND ALL EXPRESS OR IMPLIED CONDITIONS, REPRESENTATIONS AND WARRANTIES, INCLUDING ANY IMPLIED WARRANTY OF MERCHANTABILITY, FITNESS FOR A PARTICULAR PURPOSE OR NON-INFRINGEMENT, ARE DISCLAIMED, EXCEPT TO THE EXTENT THAT SUCH DISCLAIMERS ARE HELD TO BE LEGALLY INVALID.

Copyright 2000 Sun Microsystems, Inc. 901 San Antonio Road, Palo Alto, Californie 94303-4900 Etats-Unis. Tous droits réservés.

Ce produit ou document est protégé par un copyright et distribué avec des licences qui en restreignent l'utilisation, la copie, la distribution, et la décompilation. Aucune partie de ce produit ou document ne peut être reproduite sous aucune forme, par quelque moyen que ce soit, sans l'autorisation préalable et écrite de Sun et de ses bailleurs de licence, s'il y en a. Le logiciel détenu par des tiers, et qui comprend la technologie relative aux polices de caractères, est protégé par un copyright et licencié par des fournisseurs de Sun.

Des parties de ce produit pourront être dérivées du système Berkeley BSD licenciés par l'Université de Californie. UNIX est une marque déposée aux Etats-Unis et dans d'autres pays et licenciée exclusivement par X/Open Company, Ltd.

Sun, Sun Microsystems, le logo Sun, docs.sun.com, AnswerBook, AnswerBook2, et Solaris sont des marques de fabrique ou des marques déposées, ou marques de service, de Sun Microsystems, Inc. aux Etats-Unis et dans d'autres pays. Toutes les marques SPARC sont utilisées sous licence et sont des marques de fabrique ou des marques déposées de SPARC International, Inc. aux Etats-Unis et dans d'autres pays. Les produits portant les marques SPARC sont basés sur une architecture développée par Sun Microsystems, Inc.

L'interface d'utilisation graphique OPEN LOOK et Sun™ a été développée par Sun Microsystems, Inc. pour ses utilisateurs et licenciés. Sun reconnaît les efforts de pionniers de Xerox pour la recherche et le développement du concept des interfaces d'utilisation visuelle ou graphique pour l'industrie de l'informatique. Sun détient une licence non exclusive de Xerox sur l'interface d'utilisation graphique Xerox, cette licence couvrant également les licenciés de Sun qui mettent en place l'interface d'utilisation graphique OPEN LOOK et qui en outre se conforment aux licences écrites de Sun.

CETTE PUBLICATION EST FOURNIE "EN L'ETAT" ET AUCUNE GARANTIE, EXPRESSE OU IMPLICITE, N'EST ACCORDEE, Y COMPRIS DES GARANTIES CONCERNANT LA VALEUR MARCHANDE, L'APTITUDE DE LA PUBLICATION A REpondRE A UNE UTILISATION PARTICULIERE, OU LE FAIT QU'ELLE NE SOIT PAS CONTREFAISANTE DE PRODUIT DE TIERS. CE DENI DE GARANTIE NE S'APPLIQUERAIT PAS, DANS LA MESURE OU IL SERAIT TENU JURIDIQUEMENT NUL ET NON AVENU.



Contents

Preface

Part I Introduction

1. Introduction to ONC+ Technologies 23

Brief Description of ONC+ Technologies 24

TI-RPC 24

XDR 24

NFS 24

NIS+ 25

Part II Remote Procedure Call

2. Introduction to TI-RPC 29

What Is TI-RPC? 29

TI-RPC Issues 30

Parameter Passing 31

Binding 31

Transport Protocol 31

Call Semantics 31

Data Representation 32

Program, Version, and Procedure Numbers 32

Overview of Interface Routines 32

	Simplified Interface Routines	33
	Standard Interface Routines	33
	Network Selection	36
	Transport Selection	37
	Name-to-Address Translation	38
	Address Lookup Services	38
	Registering Addresses	39
	Reporting RPC Information	40
3.	rpcgen Programming Guide	41
	What is rpcgen	41
	SunOS 5.x Features	42
	Template Generation	42
	C-style Mode	42
	Multithread-Safe Code	42
	Multithread Auto Mode	42
	Library Selection	43
	ANSI C -compliant Code	43
	An rpcgen Tutorial	43
	Converting Local Procedures to Remote Procedures	43
	Passing Complex Data Structures	50
	Preprocessing Directives	55
	cpp Directive	56
	Compile-Time Flags	56
	Client and Server Templates	57
	C-style Mode	58
	MT-Safe Code	60
	MT Auto Mode	66
	TI-RPC or TS-RPC Library Selection	67

ANSI C-compliant Code	67
xdr_inline() Count	68
rpcgen Programming Techniques	69
Network Types/Transport Selection	69
Command Line Define Statements	70
Server Response to Broadcast Calls	70
Port Monitor Support	71
Time-out Changes	71
Client Authentication	72
Dispatch Tables	73
64-bit Considerations for rpcgen	74
IPv6 Considerations for RPCGEN	75
Debugging Applications	75
4. The Programmer's Interface to RPC	77
RPC Is Multithread Safe	77
Simplified Interface	78
Client	79
Server	80
Hand-Coded Registration Routine	81
Passing Arbitrary Data Types	82
Standard Interfaces	86
Top Level Interface	86
Intermediate Level Interface	90
Expert Level Interface	93
Bottom Level Interface	98
Server Caching	99
Low-Level Data Structures	99
Testing Programs Using Low-level Raw RPC	102

Advanced RPC Programming Techniques	104
poll() on the Server Side	105
Broadcast RPC	106
Batching	108
Authentication	111
Authentication Using RPCSEC_GSS	118
Using Port Monitors	130
Multiple Server Versions	132
Multiple Client Versions	133
Using Transient RPC Program Numbers	135
Multithreaded RPC Programming	136
MT Client Overview	137
MT Server Overview	141
MT Auto Mode	143
MT User Mode	146
Connection-Oriented Transports	153
Memory Allocation With XDR	156
Porting From TS-RPC to TI-RPC	158
Porting an Application	158
Benefits of Porting	158
IPv6 Considerations for RPC	159
Porting Issues	160
Differences Between TI-RPC and TS-RPC	160
Function Compatibility Lists	161
Comparison Examples	164
Part III NIS+	
5. NIS+ Programming Guide	171
NIS+ Overview	171

	Domains	171
	Servers	172
	Tables	172
	NIS+ Security	173
	Name Service Switch	173
	NIS+ Administration Commands	173
	NIS+ API	175
	NIS+ Sample Program	180
	Unsupported Macros	181
	Functions Used in the Example	181
	Program Compilation	181
A.	XDR Technical Note	195
	What is XDR	195
	A Canonical Standard	199
	The XDR Library	200
	XDR Library Primitives	202
	Memory Requirements for XDR Routines	202
	Number Filters	204
	Floating Point Filters	205
	Enumeration Filters	205
	No-Data Routine	206
	Constructed Data Type Filters	206
	Strings	206
	Byte Arrays	207
	Arrays	207
	Opaque Data	210
	Fixed-Length Arrays	211
	Discriminated Unions	211

Pointers	213
Nonfilter Primitives	214
Operation Directions	215
Stream Access	215
Standard I/O Streams	215
Memory Streams	216
Record (TCP/IP) Streams	216
XDR Stream Implementation	218
The XDR Object	218
Advanced Topics	219
Linked Lists	220
B. RPC Protocol and Language Specification	223
Protocol Overview	223
The RPC Model	224
Transports and Semantics	224
Binding and Rendezvous Independence	225
Program and Procedure Numbers	226
Program Number Assignment	227
Program Number Registration	228
Other Uses of the RPC Protocol	228
The RPC Message Protocol	229
Record-Marking Standard	232
Authentication Protocols	232
AUTH_NONE	233
AUTH_SYS	233
AUTH_DES Authentication	234
AUTH_DES Authentication Verifiers	235
Nicknames and Clock Synchronization	236

	DES Authentication Protocol (in XDR language)	236
	AUTH_KERB Authentication	239
	The RPC Language Specification	243
	An Example Service Described in the RPC Language	243
	RPCL Syntax	244
	Enumerations	245
	Constants	246
	Type Definitions	246
	Declarations	246
	Simple Declarations	246
	Fixed-Length Array Declarations	247
	Variable-Length Array Declarations	247
	Pointer Declarations	248
	Structures	248
	Unions	249
	Programs	249
	Special Cases	250
	rpcbind Protocol	251
	rpcbind Operation	256
	Version 4 rpcbind	258
	Bibliography	259
C.	XDR Protocol Specification	261
	XDR Protocol Introduction	261
	Graphic Box Notation	262
	Basic Block Size	262
	XDR Data Type Declarations	262
	Signed Integer	263
	Unsigned Integer	263

Enumerations	264
Booleans	264
Hyper Integer and Unsigned Hyper Integer	265
Floating Point	266
Quadruple-Precision Floating Point	267
Fixed-Length Opaque Data	268
Variable-Length Opaque Data	268
Counted Byte Strings	269
Fixed-Length Array	270
Variable-Length Array	271
Structure	271
Discriminated Union	272
Void	273
Constant	273
Typedef	273
Optional-Data	274
The XDR Language Specification	275
Notational Conventions	275
Lexical Notes	275
Syntax Notes	277
XDR Data Description	278
RPC Language Reference	279
Enumerations	280
Constants	280
Type Definitions	280
Declarations	281
Simple Declarations	281
Fixed-Length Array Declarations	281

	Variable-Length Array Declarations	282
	Pointer Declarations	282
	Structures	282
	Unions	283
	Programs	284
	Special Cases	285
D.	Live RPC Code Examples	287
	Directory Listing Program and Support Routines (<code>rpcgen</code>)	287
	Time Server Program (<code>rpcgen</code>)	291
	Add Two Numbers Program (<code>rpcgen</code>)	292
	Spray Packets Program (<code>rpcgen</code>)	292
	Print Message Program With Remote Version	294
	Batched Code Example	297
	Non-Batched Example	299
E.	The <code>portmap</code> Utility	301
	System Registration Overview	301
	<code>portmap</code> Protocol	302
	<code>portmap</code> Operation	304
	<code>PMAPPROC_NULL</code>	304
	<code>PMAPPROC_SET</code>	304
	<code>PMAPPROC_UNSET</code>	305
	<code>PMAPPROC_GETPORT</code>	305
	<code>PMAPPROC_DUMP</code>	305
	<code>PMAPPROC_CALLIT</code>	305
	Bibliography	306
F.	Writing a Port Monitor With the Service Access Facility (SAF)	307
	What Is the <code>SAF</code>	307
	What Is the <code>SAC</code>	308

Basic Port Monitor Functions	309
Port Management	309
Activity Monitoring	309
Other Port Monitor Functions	310
Terminating a Port Monitor	311
SAF Files	311
The Port Monitor Administrative File	311
Per-Service Configuration Files	312
Private Port Monitor Files	312
The SAC/Port Monitor Interface	312
Message Formats	312
Message Classes	314
The Port Monitor Administrative Interface	314
The SAC Administrative File <code>_sactab</code>	315
The Port Monitor Administrative File <code>_pmtab</code>	315
The SAC Administrative Command <code>sacadm</code>	317
The Port Monitor Administrative Command <code>pmadm</code>	318
Monitor-Specific Administrative Command	318
The Port Monitor/Service Interface	318
Port Monitor Requirements	319
Important Files	319
Port Monitor Responsibilities	320
Configuration Files and Scripts	321
Interpreting Configuration Scripts With <code>doconfig()</code>	321
The Per-System Configuration File	321
Per-Port Monitor Configuration Files	322
Per-Service Configuration Files	322
The Configuration Language	322

Printing, Installing, and Replacing Configuration Scripts	323
Sample Port Monitor Code	325
Logic Diagram and Directory Structure	331
/etc/saf/_sysconfig	332
/etc/saf/_sactab	332
/etc/saf/pmtag	332
/etc/saf/pmtag/_config	332
/etc/saf/pmtag/_pmtab	333
/etc/saf/pmtag/svctag	333
/etc/saf/pmtag/_pid	333
/etc/saf/pmtag/_pmpipe	333
/var/saf/_log	333
/var/saf/pmtag	333
Glossary	335
Index	339

Preface

The *ONC+ Developer's Guide* describes the programming interfaces to remote procedure call (RPC) and NIS+, a network name service, which belong to the ONC+™ distributed services developed at Sun Microsystems™, Inc.

In this guide, the terms SunOS™ and Solaris™ are used interchangeably because the interfaces described in this manual are common to both. Solaris 8 is Sun Microsystems's distributed computing operating environment. It is comprised of SunOS release 5.8 with the ONC+ technologies, OpenWindows™, ToolTalk™, DeskSet™, and OPEN LOOK® as well as other utilities.

All utilities, their options, and library functions in this manual reflect the current Solaris system software developed by Sun Microsystems Inc. If you are using a previous version of Solaris system software, some utilities and library functions may function differently.

Who Should Use This Guide

The guide assists you in converting an existing single-computer application to a networked, distributed application, or developing and implementing distributed applications.

Use of this guide assumes basic competence in programming, a working familiarity with the C programming language, and a working familiarity with the UNIX® operating system. Previous experience in network programming is helpful, but is not required to use this manual.

How This Guide Is Organized

Part One—Introduction

Chapter 1 gives a high-level introduction to the ONC+ distributed computing platform and services.

Part Two—Remote Procedure Call (RPC)

Chapter 2 introduces TI-RPC.

Chapter 3 describes how the `rpcgen` tool generates client and server stubs.

Chapter 4 describes the use of RPC in the programming environment.

Part Three—NIS+ Applications Programming Interface

Chapter 5 describes the NIS+ applications programming interface.

Appendixes

Appendix A describes XDR and how it is used in data formatting and type conversion.

Appendix B describes the protocol of RPC usage, both syntax and limitations.

Appendix C describes the XDR protocol and language.

Appendix D contains complete functional listings of some of the code included in the document as examples.

Appendix E describes the portmap utility and its function. This appendix is included in this document to aid migrating applications written to run on earlier releases of SunOS.

Appendix F describes the process of writing a port monitor application under the SAF and is included as a reference for applications development.

Related Books and Sites

The following on-line System AnswerBook® products cover related network programming topics:

- *Solaris 8 Reference Manual Collection*
- *Solaris 8 Software Developer Collection*

For information on Sun Microsystem's NFS® distributed computing file system, see the following sources:

- "NFS: Network File System Protocol Specification version 3," RFC 1813, (Mar), Sun Microsystems
- "NFS: Network File System Version 3 Protocol Specification," Sun Microsystems, 1993. Postscript copies available via anonymous ftp:
- <ftp.uu.net:/networking/ip/nfs/NFS3.spec.ps.Z> <bcm.tmc.edu:/nfs/nfsv3.ps.Z> <gatekeeper.dec.com:/pub/standards/nfs/nfsv3.ps.Z>
- 1094 NFS: Network File System Protocol specification (version 2)
- 1509 Generic Security Service API: C-bindings
- 1510 The Kerberos Network Authentication Service (V5)
- 1813 NFS Version 3 Protocol Specification
- 1831 RPC: Remote Procedure Call Protocol Specification Version 2
- 1832 XDR: External Data Representation Standard
- 1833 Binding Protocols for ONC RPC Version 2
- 2078 Generic Security Service Application Program Interface
- 2203 RPCSEC_GSS Protocol Specification

The following third-party books and articles are excellent sources on network programming topics:

- *UNIX Network Programming*, W. Richard Stevens (Prentice Hall Software Series, 1990)
- *Power Programming with RPC*, John Bloomer (O'Reilly & Associates, Inc, 1992)
- *Networking Applications on UNIX System V Release 4*, Michael Padovano (Prentice Hall, Inc., 1993)
- *Distributed Computing: Implementation and Management Strategies* (Edited by Raman Khanna. Prentice Hall, 1993)
- *Using Encryption for Authentication in Large Networks of Computers*, R.M. Needham and M.D. Schroeder in *Communications of the ACM* (Vol. 21, No. 12, pages 993-999, 1978)

- *Section E.2.1: Kerberos Authentication and Authorization System*, S.P. Miller, B.C. Neuman, J.I. Schiller and J.H. Saltzer (*Project Athena Technical Plan*, MIT Project Athena, December 1987)
- *Kerberos: An Authentication Service for Open Network Systems*, J.G. Steiner, B.C. Neuman, and J.I. Schiller (Usenix Conference Proceedings, Dallas, TX, pages 191-202, February, 1988)

Ordering Sun Documents

Fatbrain.com, an Internet professional bookstore, stocks select product documentation from Sun Microsystems, Inc.

For a list of documents and how to order them, visit the Sun Documentation Center on Fatbrain.com at <http://www1.fatbrain.com/documentation/sun>.

Accessing Sun Documentation Online

The docs.sun.comSM Web site enables you to access Sun technical documentation online. You can browse the docs.sun.com archive or search for a specific book title or subject. The URL is <http://docs.sun.com>.

What Typographic Conventions Mean

The following table describes the typographic changes used in this book.

TABLE P-1 Typographic Conventions

Typeface or Symbol	Meaning	Example
AaBbCc123	The names of commands, files, and directories; on-screen computer output	Edit your <code>.login</code> file. Use <code>ls -a</code> to list all files. machine_name% you have mail.
AaBbCc123	What you type, contrasted with on-screen computer output	machine_name% su Password:
<i>AaBbCc123</i>	Command-line placeholder: replace with a real name or value	To delete a file, type rm <i>filename</i> .
<i>AaBbCc123</i>	Book titles, new words, or terms, or words to be emphasized.	Read Chapter 6 in <i>User's Guide</i> . These are called <i>class</i> options. You must be <i>root</i> to do this.

Shell Prompts in Command Examples

The following table shows the default system prompt and superuser prompt for the C shell, Bourne shell, and Korn shell.

TABLE P-2 Shell Prompts

Shell	Prompt
C shell prompt	machine_name%
C shell superuser prompt	machine_name#
Bourne shell and Korn shell prompt	\$
Bourne shell and Korn shell superuser prompt	#

PART I Introduction

Part I is an introduction to the ONC+ services.

- Chapter 1



Introduction to ONC+ Technologies

This section is a short introduction to ONC+ technologies, the Sun Microsystem's open systems distributed computing environment. The ONC+ technologies are the core services available to developers who implement distributed applications in a heterogeneous distributed computing environment. ONC+ technologies also includes tools to administer client/server networks.

Figure 1-1 shows an integrated view of how client-server applications are built on top of ONC+ technologies, and how they sit on top of the low-level networking protocols:

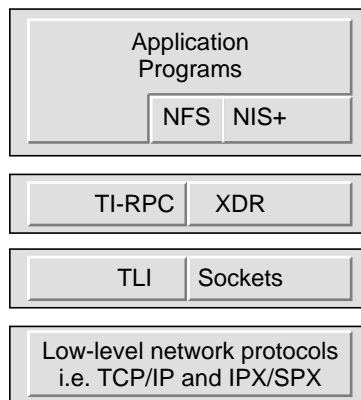

Figure 1-1 ONC+ Distributed Computing Platform

Brief Description of ONC+ Technologies

ONC+ technologies consist of a family of technologies, services, and tools. It is backward compatible, and interoperates with the installed base of ONC services. The main components are described. This guide covers the technologies that require the use of programming facilities.

TI-RPC

Transport-independent remote procedure call (TI-RPC) was developed as part of the UNIX System V Release 4 (SVR4). It makes RPC applications transport-independent by allowing a single binary version of a distributed program to run on multiple transports. Previously, with transport-specific RPC, the transport was bound at compile time so that applications could not use other transports unless the program was rebuilt. With TI-RPC, applications can use new transports if the system administrator updates the network configuration file and restarts the program. Thus, no changes are required to the binary application.

XDR

External data representation (XDR) is an architecture-independent specification for representing data. It resolves the differences in data byte ordering, data type size, representation, and alignment between different architectures. Applications that use XDR may exchange data across heterogeneous hardware systems.

NFS

NFS is the Sun Microsystems distributed computing file system that provides transparent access to remote file systems on heterogeneous networks. In this way, users can share files among PCs, workstations, mainframes, and supercomputers. As long as they are connected to the same network, the files appear as though they are on the user's desktop. The NFS environment features Kerberos V5 authentication, multithreading, the network lock manager, and the automounter.

NFS does not have programming facilities, so it is not covered in this guide. However, the specification for NFS is available through anonymous ftp. See "Related Books and Sites" on page for more information.

NIS+

NIS+ is the enterprise naming service in the Solaris environment. It provides a scalable and secure information base for host names, network addresses, and user names. It makes administration of large, multivendor client/server networks easier by being the central point for adding, removing, and relocating network resources. Changes made to the NIS+ information base are automatically and immediately propagated to replica servers across the network; this ensures that system uptime and performance is preserved. Security is integral to NIS+. Unauthorized users and programs are prevented from reading, changing, or destroying naming service information.

PART II Remote Procedure Call

Part 2 covers RPC topics

- Chapter 2
- Chapter 3
- Chapter 4



Introduction to TI-RPC

This section provides an overview of TI-RPC, also known as Sun RPC. The information presented is most useful to someone new to RPC. (See also *Glossary* for the definition of the terms used in this guide.)

- “What Is TI-RPC?” on page 29
- “TI-RPC Issues” on page 30
- “Overview of Interface Routines” on page 32
- “Network Selection” on page 36
- “Transport Selection” on page 37
- “Address Lookup Services” on page 38

What Is TI-RPC?

TI-RPC is a powerful technique for constructing distributed, client-server based applications. It is based on extending the notion of conventional, or local procedure calling, so that the called procedure need not exist in the same address space as the calling procedure. The two processes might be on the same system, or they might be on different systems with a network connecting them.

By using RPC, programmers of distributed applications avoid the details of the interface with the network. The transport independence of RPC isolates the application from the physical and logical elements of the data communications mechanism and enables the application to use a variety of transports.

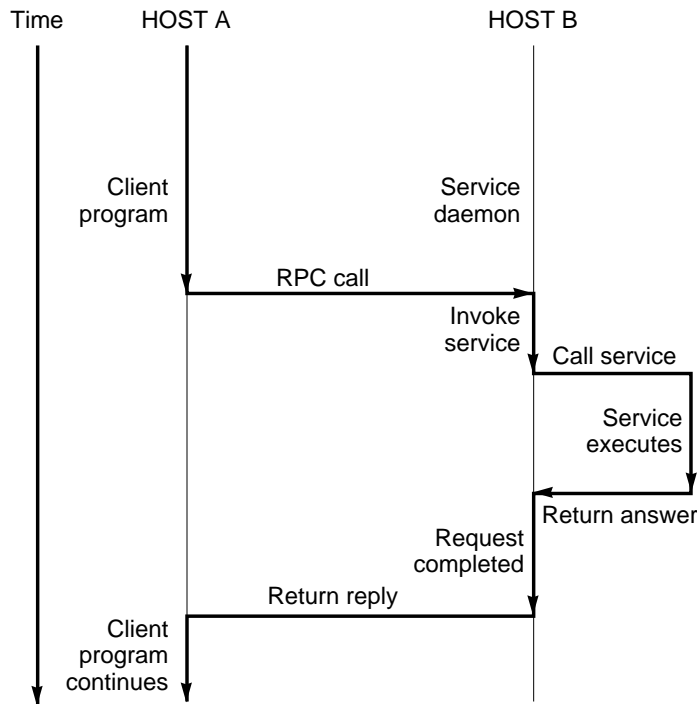

Figure 2-1 How RPC Works

An RPC is analogous to a function call. Like a function call, when an RPC is made, the calling arguments are passed to the remote procedure and the caller waits for a response to be returned from the remote procedure.

Figure 2-1 shows the flow of activity that takes place during an RPC call between two networked systems. The client makes a procedure call that sends a request to the server and waits. The thread is blocked from processing until either a reply is received, or it times out. When the request arrives, the server calls a dispatch routine that performs the requested service, and sends the reply to the client. After the RPC call is completed, the client program continues.

RPC specifically supports network applications. TI-RPC runs on available networking mechanisms such as TCP/IP. Other RPC standards are OSF DCE (based on Apollo's NCS system), Xerox Courier, and Netwise.

TI-RPC Issues

A number of issues help to characterize a particular RPC implementation.

- How are parameters and results passed?

- How is binding carried out?
- How are transport protocols dealt with?
- What are the call semantics?
- What data representation is used?

Parameter Passing

TI-RPC allows a single parameter to be passed from client to server. If more than one parameter is required, the components can be combined into a structure, that is counted as a single element. Information passed from server to client is passed as the function's return value. Information cannot be passed back from server to client through the parameter list.

Binding

The client must know how to contact the service. The two necessary aspects are finding out which host the server is on, and then connecting to the actual server process. On each host, a service called `rpcbind` manages RPC services. TI-RPC uses the available host-naming services, such as the `hosts` and `ipnodes` file, NIS+, and DNS, to locate a host.

Transport Protocol

The transport protocol specifies how the call message and the reply message are transmitted between client and server. TS-RPC used TCP and UDP as transport protocols, but the current version of TI-RPC is transport independent; that is, it works with any transport protocol.

Call Semantics

Call semantics has to do with what the client can assume about the execution of the remote procedure; in particular, how many times the procedure was executed. This is important in dealing with error conditions. The three alternatives are *exactly once*, *at most once*, and *at least once*. ONC+ provides *at least once* semantics. Procedures called remotely are *idempotent*: they should return the same result each time they are called, even if it is several times.

Data Representation

Data representation describes the format used for parameters and results as they are passed between processes. For RPC to function on a variety of system architectures requires a standard data representation. TI-RPC uses external data representation (XDR). XDR is a machine-independent data description and encoding protocol. Using XDR, RPC can handle arbitrary data structures, regardless of different hosts' byte orders or structure layout conventions. For a detailed discussion of XDR, see Appendix C, and Appendix A.

Program, Version, and Procedure Numbers

A remote procedure is uniquely identified by the triple:

- program number
- version number
- procedure number

The *program* number identifies a group of related remote procedures, each of which has a unique procedure number.

A program can consist of one or more *versions*. Each version consists of a collection of procedures that are available to be called remotely. Version numbers enable multiple versions of an RPC protocol to be available simultaneously.

Each version contains a number of procedures that can be called remotely. Each procedure has a *procedure* number.

“Program and Procedure Numbers” on page 226 lists the range of values and their significance and tells you how to have a program number assigned to your RPC program. A list of mappings of RPC service name to program number is available in the rpc network database, `/etc/rpc`.

Overview of Interface Routines

RPC has multiple levels of application interface to its services. These levels provide different degrees of control balanced with different amounts of interface code to implement, in order of increasing control and complexity. This section gives a summary of the routines available at each level.

Simplified Interface Routines

The simplified interfaces are used to make remote procedure calls to routines on other machines, and specify only the type of transport to use. The routines at this level are used for most applications. You can find descriptions and code samples in the section “Simplified Interface” on page 78.

TABLE 2-1 RPC Routines—Simplified Level

Routine	Function
<code>rpc_reg()</code>	Registers a procedure as an RPC program on all transports of the specified type
<code>rpc_call()</code>	Remote calls the specified procedure on the specified remote host
<code>rpc_broadcast()</code>	Broadcasts a call message across all transports of the specified type

Standard Interface Routines

The standard interfaces are divided into *top level*, *intermediate level*, *expert level*, and *bottom level*. These interfaces give a developer much greater control over communication parameters such as the transport being used, how long to wait before responding to errors and retransmitting requests, and so on.

Top Level Routines

At the top level, the interface is still simple, but the program has to create a client handle before making a call or create a server handle before receiving calls. If you want the application to run on all transports, use this interface. You can find the use of these routines and code samples in “Top Level Interface” on page 86.

TABLE 2-2 RPC Routines—Top Level

Routine	Description
<code>clnt_create()</code>	Generic client creation. The program tells <code>clnt_create()</code> where the server is located and the type of transport to use.
<code>clnt_create_timed()</code>	Similar to <code>clnt_create()</code> but lets the programmer specify the maximum time allowed for each type of transport tried during the creation attempt.
<code>svc_create()</code>	Creates server handles for all transports of the specified type. The program tells <code>svc_create()</code> which dispatch function to use.
<code>clnt_call()</code>	Client calls a procedure to send a request to the server.

Intermediate-Level Routines

The intermediate level interface of RPC enables you to you control details. Programs written at these lower levels are more complicated but run more efficiently. The intermediate level enables you to specify the transport to use. You can find the use of these routines and code samples in “Intermediate Level Interface” on page 90.

TABLE 2-3 RPC Routines—Intermediate Level

Routine	Description
<code>clnt_tp_create()</code>	Creates a client handle for the specified transport
<code>clnt_tp_create_timed()</code>	Similar to <code>clnt_tp_create()</code> but lets the programmer specify the maximum time allowed
<code>svc_tp_create()</code>	Creates a server handle for the specified transport
<code>clnt_call()</code>	Client calls a procedure to send a request to the server

Expert-Level Routines

The expert level contains a larger set of routines with which to specify transport-related parameters. You can find the use of these routines and code samples in “Expert Level Interface” on page 93.

TABLE 2-4 RPC Routines—Expert Level

Routine	Description
<code>clnt_tli_create()</code>	Creates a client handle for the specified transport
<code>svc_tli_create()</code>	Creates a server handle for the specified transport
<code>rpcb_set()</code>	Calls <code>rpcbind</code> to set a map between an RPC service and a network address
<code>rpcb_unset()</code>	Deletes a mapping set by <code>rpcb_set()</code>
<code>rpcb_getaddr()</code>	Calls <code>rpcbind</code> to get the transport addresses of specified RPC services
<code>svc_reg()</code>	Associates the specified program and version number pair with the specified dispatch routine
<code>svc_unreg()</code>	Deletes an association set by <code>svc_reg()</code>
<code>clnt_call()</code>	Client calls a procedure to send a request to the server

Bottom Level Routines

The bottom level contains routines used for full control of transport options. “Bottom Level Interface” on page 98 describes these routines.

TABLE 2-5 RPC Routines—Bottom Level

Routine	Description
<code>clnt_dg_create()</code>	Creates an RPC client handle for the specified remote program, using a connectionless transport
<code>svc_dg_create()</code>	Creates an RPC server handle, using a connectionless transport
<code>clnt_vc_create()</code>	Creates an RPC client handle for the specified remote program, using a connection-oriented transport

TABLE 2-5 RPC Routines—Bottom Level (continued)

Routine	Description
<code>svc_vc_create()</code>	Creates an RPC server handle, using a connection-oriented transport
<code>clnt_call()</code>	Client calls a procedure to send a request to the server

Network Selection

You can write programs to run on a specific transport or transport type, or to operate on a system- or user-chosen transport. Two mechanisms for network selection are the `/etc/netconfig` database and the environmental variable `NETPATH`. These mechanisms enable a fine degree of control over network selection: a user can specify a preferred transport, and if it can, an application uses it. If the specified transport is inappropriate, the application automatically tries others with the right characteristics.

`/etc/netconfig` lists the transports available to the host and identifies them by type. `NETPATH` is optional and enables a user to specify a transport or selection of transports from the list in `/etc/netconfig`. By setting the `NETPATH`, the user specifies the order in which the application tries the available transports. If `NETPATH` is not set, the system defaults to all visible transports specified in `/etc/netconfig`, in the order they appear in that file.

For more details on network selection, refer to the *Transport Interfaces Programming Guide* or see the `getnetconfig(3NSL)` and `netconfig(4)` man pages.

RPC divides selectable transports into the following types.

TABLE 2-6 nettype Parameters

Value	Meaning
<code>NULL</code>	Same as selecting <code>netpath</code>
<code>visible</code>	Uses the transports chosen with the visible flag ('v') set in their <code>/etc/netconfig</code> entries
<code>circuit_v</code>	Same as <code>visible</code> , but restricted to connection-oriented transports. Transports are selected in the order listed in <code>/etc/netconfig</code>

TABLE 2-6 nettype Parameters (continued)

Value	Meaning
datagram_v	Same as visible, but restricted to connectionless transports
circuit_n	Uses the connection-oriented transports chosen in the order defined in NETPATH
datagram_n	Uses the connectionless transports chosen in the order defined in NETPATH
udp	Specifies Internet uUser Datagram Protocol (UDP)
tcp	Specifies Internet Transport Control Protocol (TCP)

Transport Selection

RPC services are supported on both circuit-oriented and datagram transports. The selection of the transport depends on the requirements of the application.

A datagram transport is the transport of choice if the application has all of the following characteristics:

- Calls to the procedures do not change the state of the procedure or of associated data.
- The size of both the arguments and results is smaller than the transport packet size.
- The server is required to handle hundreds of clients. A datagram server does not keep any state data on clients, so it can potentially handle many clients. A circuit-oriented server keeps state data on each open client connection, so the number of clients is limited by the host resources.

A circuit-oriented transport is the transport of choice if the application has any of the following characteristics:

- The application can tolerate or amortize the higher cost of connection setup compared to datagram transports.
- Calls to the procedures can change the state of the procedure or of associated data.
- The size of either the arguments or the results exceeds the maximum size of a datagram packet.

Name-to-Address Translation

Each transport has an associated set of routines that translate between universal network addresses (string representations of transport addresses) and the local address representation. These universal addresses are passed around within the RPC system (for example, between `rpcbind` and a client). A run-time linkable library that contains the name-to-address translation routines is associated with each transport. Table 2-7 shows the main translation routines.

For more details on these routines, see the `netdir(3NSL)` man page and the *Transport Interfaces Programming Guide*. Note that the `netconfig` structure in each case provides the context for name-to-address translations.

TABLE 2-7 Name-to-Address Translation Routines

<code>netdir_getbyname()</code>	Translates from host/service pairs (e.g. <code>server1, rpcbind</code>) and a <code>netconfig</code> structure to a set of <code>netbuf</code> addresses. <code>netbufs</code> are Transport Level Interface (TLI) structures that contain transport-specific addresses at run-time.
	Translates from <code>netbuf</code> addresses and a <code>netconfig</code> structure to host/service pairs.
<code>uaddr2taddr()</code>	Translates from universal addresses and a <code>netconfig</code> structure to <code>netbuf</code> addresses.
<code>taddr2uaddr()</code>	Translates from <code>netbuf</code> addresses and a <code>netconfig</code> structure to universal addresses.

Address Lookup Services

Transport services do not provide address-lookup services. They provide only message transfer across a network. A client program needs a way to obtain the address of its server program. In earlier system releases this service was performed by `portmap`. `rpcbind` replaces the `portmap` utility.

RPC makes no assumption about the structure of a network address. It deals with universal addresses specified only as null-terminated strings of ASCII characters. RPC translates universal addresses into local transport addresses by using routines specific to the transport. For more details on these routines, see the `netdir(3NSL)` and `rpcbind(3NSL)` man pages.

`rpcbind` provides the operations:

- Add a registration
- Delete a registration
- Get address of a specified program number, version number, and transport
- Get the complete registration list
- Perform a remote call for a client
- Return the time

Registering Addresses

`rpcbind` maps RPC services to their addresses, so its address must be known. The name-to-address translation routines must reserve a known address for each type of transport used. For example, in the Internet domain, `rpcbind` has port number 111 on both TCP and UDP. When `rpcbind` is started, it registers its location on each of the transports supported by the host. `rpcbind` is the only RPC service that must have a known address.

For each supported transport, `rpcbind` registers the addresses of RPC services and makes the addresses available to clients. A service makes its address available to clients by registering the address with the `rpcbind` daemon. The address of the service is then available to `rpcinfo(1M)` and to programs using library routines named in the `rpcbind(3NSL)` man page. No client or server can assume the network address of an RPC service.

Client and server programs and client and server hosts are usually distinct but they need not be. A server program can also be a client program. When one server calls another `rpcbind` server it makes the call as a client.

To find a remote program's address, a client sends an RPC message to a host's `rpcbind` daemon. If the service is on the host, the daemon returns the address in an RPC reply message. The client program can then send RPC messages to the server's address. (A client program can minimize its calls to `rpcbind` by storing the network addresses of recently called remote programs.)

The `RPCBPROC_CALLIT` procedure of `rpcbind` lets a client make a remote procedure call without knowing the address of the server. The client passes the target procedure's program number, version number, procedure number, and calling arguments in an RPC call message. `rpcbind` looks up the target procedure's address in the address map and sends an RPC call message, including the arguments received from the client, to the target procedure.

When the target procedure returns results, `RPCBPROC_CALLIT` passes them to the client program. It also returns the target procedure's universal address so that the client can later call it directly.

The RPC library provides an interface to all `rpcbind` procedures. Some of the RPC library procedures also call `rpcbind` automatically for client and server programs. For details, see Appendix B.

Reporting RPC Information

`rpcinfo` is a utility that reports current RPC information registered with `rpcbind`. `rpcinfo` (with either `rpcbind` or the `portmap` utility) reports the universal addresses and the transports for all registered RPC services on a specified host. It can call a specific version of a specific program on a specific host and report whether a response is received. It can also delete registrations. For details, see the `rpcinfo(1M)` manpage.

rpcgen Programming Guide

This section introduces the `rpcgen` tool and provides a tutorial with code examples and usage of the available compile-time flags. See *Glossary* for the definition of the terms used in this chapter.

- “SunOS 5.x Features” on page 42
- “An `rpcgen` Tutorial” on page 43
- “Compile-Time Flags” on page 56
- “`rpcgen` Programming Techniques” on page 69

What is `rpcgen`

The `rpcgen` tool generates remote program interface modules. It compiles source code written in the RPC Language. RPC Language is *similar* in syntax and structure to C. `rpcgen` produces one or more C language source modules, which are then compiled by a C compiler.

The default output of `rpcgen` is:

- A header file of definitions common to the server and the client
- A set of XDR routines that translate each data type defined in the header file
- A stub program for the server
- A stub program for the client

`rpcgen` can optionally generate:

- Various transports
- A time-out for servers

- Server stubs that are MT safe
- Server stubs that are not `main` programs
- C-style arguments passing ANSI C-compliant code
- An RPC dispatch table that checks authorizations and invokes service routines

`rpcgen` significantly reduces the development time that would otherwise be spent developing low-level routines. Handwritten routines link easily with the `rpcgen` output. (For a discussion of RPC programming without `rpcgen`, see Chapter 4.)

SunOS 5.x Features

This section lists the features found in the current `rpcgen` code generator that are not found in previous versions.

Template Generation

`rpcgen` generates client-side, server-side, and makefile templates. See “Client and Server Templates” on page 57 for the list of options.

C-style Mode

`rpcgen` has two compilation modes, C-style and default. C-style mode lets arguments be passed by value, instead of as pointers to a structure. It also supports passing multiple arguments. The default mode is the same as in previous releases. See “C-style Mode” on page 58 for the example code for both modes.

Multithread-Safe Code

`rpcgen` can now generate MT-safe code for use in a threaded environment. By default, the code generated by `rpcgen` is not MT-safe. See “MT-Safe Code” on page 60 for the description and example code.

Multithread Auto Mode

`rpcgen` can generate MT-safe server stubs that operate in the MT Auto mode. See “MT Auto Mode” on page 66 for the definition and example code.

Library Selection

`rpcgen` can use library calls for either TS-RPC or TI-RPC. See “TI-RPC or TS-RPC Library Selection” on page 67.

ANSI C -compliant Code

The output generated by `rpcgen` conforms to ANSI C standards. The code can also be used in the Sun Workshop™ Compilers C++ environment. See “ANSI C-compliant Code” on page 67.

An `rpcgen` Tutorial

`rpcgen` provides programmers a simple and direct way to write distributed applications. Server procedures may be written in any language that observes procedure-calling conventions. They are linked with the server stub produced by `rpcgen` to form an executable server program. Client procedures are written and linked in the same way.

This section presents some basic `rpcgen` programming examples. Refer also to the `rpcgen(1)` man page.

Converting Local Procedures to Remote Procedures

Assume that an application runs on a single computer and you want to convert it to run in a “distributed” manner on a network. This example shows the stepwise conversion of this program that writes a message to the system console. Code Example 3-1 shows the original program.

CODE EXAMPLE 3-1 Single Process Version of `printmsg.c`

```
/* printmsg.c: print a message on the console */
#include <stdio.h>

main(argc, argv)
int argc;
char *argv[];
{
    char *message;
```

(continued)

(Continuation)

```
if (argc != 2) {
    fprintf(stderr, "usage: %s <message>\n",
           argv[0]);
    exit(1);
}
message = argv[1];
if (!printmessage(message)) {
    fprintf(stderr, "%s: couldn't print your
           message\n", argv[0]);
    exit(1);
}
printf("Message Delivered!\n");
exit(0);
}

/* Print a message to the console.
 * Return a boolean indicating whether
 * the message was actually printed. */

printmessage(msg)
char *msg;
{
    FILE *f;

    f = fopen("/dev/console", "w");
    if (f == (FILE *)NULL) {
        return (0);
    }
    fprintf(f, "%s\n", msg);
    fclose(f);
    return(1);
}
```

For local use on a single machine, this program could be compiled and executed as follows:

```
$ cc printmsg.c -o printmsg
$ printmsg "Hello, there."
Message delivered!
$
```

If the `printmessage()` function is turned into a remote procedure, it can be called from anywhere in the network. `rpcgen` makes it easy to do this.

First, determine the data types of all procedure-calling arguments and the result argument. The calling argument of `printmessage()` is a string, and the result is an integer. We can write a protocol specification in RPC language that describes the

remote version of `printmessage()`. The RPC language source code for such a specification is:

```
/* msg.x: Remote msg printing protocol */
program MESSAGEPROG {
    version PRINTMESSAGEVERS {
        int PRINTMESSAGE(string) = 1;
    } = 1;
} = 0x20000001;
```

Remote procedures are always declared as part of remote programs. The code above declares an entire remote program that contains the single procedure `PRINTMESSAGE`. In this example, the `PRINTMESSAGE` procedure is declared to be procedure 1, in version 1 of the remote program `MESSAGEPROG`, with the program number `0x20000001`. (See Appendix B for guidance on choosing program numbers.) Version numbers are incremented when functionality is changed in the remote program. Existing procedures can be changed or new ones can be added. More than one version of a remote program can be defined and a version can have more than one procedure defined.

Note that the program and procedure names are declared with all capital letters. This is not required, but is a good convention to follow.

Note also that the argument type is `string` and not `char *` as it would be in C. This is because a `char *` in C is ambiguous. `char` usually means an array of characters, but it could also represent a pointer to a single character. In RPC language, a null-terminated array of `char` is called a `string`.

There are just two more programs to write:

- The remote procedure itself
- The main client program that calls it

Code Example 3-2 is a remote procedure that implements the `PRINTMESSAGE` procedure in Code Example 3-1.

CODE EXAMPLE 3-2 RPC Version of `printmsg.c`

```
/*
 * msg_proc.c: implementation of the
 * remote procedure "printmessage"
 */
#include <stdio.h>
#include "msg.h" /* msg.h generated by rpcgen */

int *
printmessage_1(msg, req)
char **msg;
struct svc_req *req; /* details of call */
{
    static int result; /* must be static! */
    FILE *f;
```

(continued)

(Continuation)

```
f = fopen("/dev/console", "w");
if (f == (FILE *)NULL) {
    result = 0;
    return (&result);
}
fprintf(f, "%s\n", *msg);
fclose(f);
result = 1;
return (&result);
}
```

Note that the declaration of the remote procedure `printmessage_1()` differs from that of the local procedure `printmessage()` in four ways:

1. It takes a pointer to the character array instead of the pointer itself. This is true of all remote procedures when the `-N` option is not used: They always take pointers to their arguments rather than the arguments themselves. Without the `-N` option, remote procedures are always called with a single argument. If more than one argument is required the arguments must be passed in a `struct`.
2. It is called with two arguments. The second argument contains information on the context of an invocation: the program, version, and procedure numbers, raw and canonical credentials, and an `SVCXPRT` structure pointer (the `SVCXPRT` structure contains transport information). This information is made available in case the invoked procedure requires it to perform the request.
3. It returns a pointer to an integer instead of the integer itself. This is also true of remote procedures when the `-N` option is not used: They return pointers to the result. The result should be declared `static` *unless* the `-M` (multithread) or `-A` (Auto mode) options are used. Ordinarily, if the result is declared local to the remote procedure, references to it by the server stub are invalid after the remote procedure returns. In the case of `-M` and `-A` options, a pointer to the result is passed as a third argument to the procedure, so the result is not declared in the procedure.
4. An `_1` is appended to its name. In general, all remote procedure calls generated by `rpcgen` are named as follows: the procedure name in the program definition (here `PRINTMESSAGE`) is converted to all lowercase letters, an underbar (`_`) is appended to it, and the version number (here 1) is appended. This naming scheme allows multiple versions of the same procedure.

Code Example 3-3 shows the main client program that calls the remote procedure.

CODE EXAMPLE 3-3 Client Program to Call printmsg.c

```
/*
 * rprintmsg.c: remote version
 * of "printmsg.c"
 */
#include <stdio.h>
#include "msg.h" /* msg.h generated by rpcgen */

main(argc, argv)
int argc;
char *argv[];
{
    CLIENT *clnt;
    int *result;
    char *server;
    char *message;

    if (argc != 3) {
        fprintf(stderr, "usage: %s host
            message\n", argv[0]);
        exit(1);
    }

    server = argv[1];
    message = argv[2];
    /*
     * Create client "handle" used for
     * calling MESSAGEPROG on the server
     * designated on the command line.
     */
    clnt = clnt_create(server, MESSAGEPROG,
        PRINTMESSAGEVERS,
        "visible");
    if (clnt == (CLIENT *)NULL) {
        /*
         * Couldn't establish connection
         * with server.
         * Print error message and die.
         */
        clnt_pcreateerror(server);
        exit(1);
    }

    /*
     * Call the remote procedure
     * "printmessage" on the server
     */
    result = printmessage_1(&message, clnt);
    if (result == (int *)NULL) {
        /*
         * An error occurred while calling
         * the server.
         * Print error message and die.
         */
        clnt_perror(clnt, server);
        exit(1);
    }
}
```

(continued)

(Continuation)

```
}
/* Okay, we successfully called
 * the remote procedure.
 */
if (*result == 0) {
    /*
     * Server was unable to print
     * our message.
     * Print error message and die.
     */
    fprintf(stderr,
            "%s: could not print your message\n",argv[0]);
    exit(1);
}

/* The message got printed on the
 * server's console
 */
printf("Message delivered to %s\n",
       server);
clnt_destroy( clnt );
exit(0);
}
```

Note the following about Code Example 3-3:

1. First, a client handle is created by the RPC library routine `clnt_create()`. This client handle is passed to the stub routine that calls the remote procedure. (The client handle can be created in other ways as well. See Chapter 4 for details.) If no more calls are to be made using the client handle, destroy it with a call to `clnt_destroy()` to conserve system resources.
2. The last parameter to `clnt_create()` is `visible`, which specifies that any transport noted as `visible` in `/etc/netconfig` can be used. For further information on this, see the `/etc/netconfig` file and its description in *Transport Interfaces Programming Guide*.
3. The remote procedure `printmessage_1()` is called exactly the same way as it is declared in `msg_proc.c`, except for the inserted client handle as the second argument. It also returns a pointer to the result instead of the result.
4. The remote procedure call can fail in two ways. The RPC mechanism can fail or there can be an error in the execution of the remote procedure. In the former case, the remote procedure `printmessage_1()` returns a `NULL`. In the latter case, the error reporting is application dependent. Here, the error is returned through `*result`.

Here are the compile commands for the `printmsg` example:

```
$ rpcgen msg.x
$ cc rprintmsg.c msg_clnt.c -o rprintmsg -lnsl
$ cc msg_proc.c msg_svc.c -o msg_server -lnsl
```

First, `rpcgen` was used to generate the header files (`msg.h`), client stub (`msg_clnt.c`), and server stub (`msg_svc.c`). Then, two programs are compiled: the client program `rprintmsg` and the server program `msg_server`. The C object files must be linked with the library `libnsl`, which contains all of the networking functions, including those for RPC and XDR.

In this example, no XDR routines were generated because the application uses only the basic types that are included in `libnsl`.

Here is what `rpcgen` did with the input file `msg.x`:

1. It created a header file called `msg.h` that contained `#define` statements for `MESSAGEPROG`, `MESSAGEVERS`, and `PRINTMESSAGE` for use in the other modules. This file must be included by both the client and server modules.
2. It created the client stub routines in the `msg_clnt.c` file. Here there is only one, the `printmessage_1()` routine, that was called from the `rprintmsg` client program. If the name of an `rpcgen` input file is `FOO.x`, the client stub's output file is called `FOO_clnt.c`.
3. It created the server program in `msg_svc.c` that calls `printmessage_1()` from `msg_proc.c`. The rule for naming the server output file is similar to that of the client: for an input file called `FOO.x`, the output server file is named `FOO_svc.c`.

Once created, the server program is installed on a remote machine and run. (If the machines are homogeneous, the server binary can just be copied. If they are not, the server source files must be copied to and compiled on the remote machine.) For this example, the remote machine is called `remote` and the local machine is called `local`. The server is started from the shell on the remote system:

```
remote$ msg_server
```

Server processes generated with `rpcgen` always run in the background. It is not necessary to follow the server's invocation with an ampersand (&). Servers generated by `rpcgen` can also be invoked by port monitors like `listen()` and `inetd()`, instead of from the command line.

Thereafter, a user on `local` can print a message on the console of machine `remote` as follows:

```
local$ rprintmsg remote "Hello, there."
```

Using `rprintmsg`, a user can print a message on any system console (including the local console) when the server `msg_server` is running on the target system.

Passing Complex Data Structures

“Converting Local Procedures to Remote Procedures” on page 43 shows how to generate client and server RPC code. `rpcgen` can also be used to generate XDR routines (the routines that convert local data structures into XDR format and vice versa).

Code Example 3-4 presents a complete RPC service: a remote directory listing service, built using `rpcgen` both to generate stub routines and to generate the XDR routines.

CODE EXAMPLE 3-4 RPC Protocol Description File: `dir.x`

```
/*
 * dir.x: Remote directory listing protocol
 *
 * This example demonstrates the functions of rpcgen.
 */

const MAXNAMELEN = 255;      /* max length of directory
entry */
typedef string nametype<MAXNAMELEN>; /* director entry */
typedef struct namenode *namelist; /* link in the listing */

/* A node in the directory listing */
struct namenode {
    nametype name;          /* name of directory entry */
    namelist next;         /* next entry */
};

/*
 * The result of a READDIR operation
 *
 * a truly portable application would use
 * an agreed upon list of error codes
 * rather than (as this sample program
 * does) rely upon passing UNIX errno's
 * back.
 *
 * In this example: The union is used
 * here to discriminate between successful
 * and unsuccessful remote calls.
 */

union readdir_res switch (int errno) {
    case 0:
        namelist list; /* no error: return directory listing */
    default:
        void; /* error occurred: nothing else to return */
};

/* The directory program definition */
program DIRPROG {
    version DIRVERS {
        readdir_res
```

(continued)

(Continuation)

```
    READDIR(nametype) = 1;
  } = 1;
} = 0x20000076;
```

You can redefine types (like `readdir_res` in the example above) using the `struct`, `union`, and `enum` RPC language keywords. These keywords are not used in later declarations of variables of those types. For example, if you define a union, `foo`, you declare using only `foo`, and not `union foo`.

`rpcgen` compiles RPC unions into C structures. Do not declare C unions using the `union` keyword.

Running `rpcgen` on `dir.x` generates four output files: (1) the header file, (2) the client stub, (3) the server skeleton, and (4) the XDR routines in the file `dir_xdr.c`. This last file contains the XDR routines to convert declared data types from the host platform representation into XDR format, and vice versa.

For each RPCL data type used in the `.x` file, `rpcgen` assumes that `libnsl` contains a routine whose name is the name of the data type, prepended by the XDR routine header `xdr_` (for example, `xdr_int`). If a data type is defined in the `.x` file, `rpcgen` generates the required `xdr_` routine. If there is no data type definition in the `.x` source file (for example, `msg.x`), then no `_xdr.c` file is generated.

You can write a `.x` source file that uses a data type not supported by `libnsl`, and deliberately omit defining the type (in the `.x` file). In doing so, you must provide the `xdr_` routine. This is a way to provide your own customized `xdr_` routines. See Chapter 4 for more details on passing arbitrary data types. The server-side of the `READDIR` procedure is shown in Code Example 3-5.

CODE EXAMPLE 3-5 Server `dir_proc.c` Example

```
/*
 * dir_proc.c: remote readdir
 * implementation
 */
#include <dirent.h>
#include "dir.h"          /* Created by rpcgen */

extern int errno;
extern char *malloc();
extern char *strdup();

readdir_res *
readdir_1(dirname, req)
```

(continued)

(Continuation)

```
nametype *dirname;
struct svc_req *req;

{
  DIR *dirp;
  struct dirent *d;
  namelist nl;
  namelist *nlp;
  static readdir_res res; /* must be static! */

  /* Open directory */
  dirp = opendir(*dirname);
  if (dirp == (DIR *)NULL) {
    res.errno = errno;
    return (&res);
  }
  /* Free previous result */
  xdr_free(xdr_readdir_res, &res);
  /*
   * Collect directory entries.
   * Memory allocated here is free by
   * xdr_free the next time readdir_1
   * is called
   */
  nlp = &res.readdir_res_u.list;
  while (d = readdir(dirp)) {
    nl = *nlp = (namenode *)
      malloc(sizeof(namenode));
    if (nl == (namenode *) NULL) {
      res.errno = EAGAIN;
      closedir(dirp);
      return(&res);
    }
    nl->name = strdup(d->d_name);
    nlp = &nl->next;
  }
  *nlp = (namelist)NULL;
  /* Return the result */
  res.errno = 0;
  closedir(dirp);
  return (&res);
}
```

Code Example 3-6 shows the client-side implementation of the READDIR procedure.

CODE EXAMPLE 3-6 Client-side Implementation of rls.c

```
/*
 * rls.c: Remote directory listing client
 */

#include <stdio.h>
#include "dir.h"                /* generated by rpcgen */

extern int errno;

main(argc, argv)
int argc;
char *argv[];
{
    CLIENT *clnt;
    char *server;
    char *dir;
    readdir_res *result;
    namelist nl;

    if (argc != 3) {
        fprintf(stderr, "usage: %s host
            directory\n", argv[0]);
        exit(1);
    }
    server = argv[1];
    dir = argv[2];
    /*
     * Create client "handle" used for
     * calling MESSAGEPROG on the server
     * designated on the command line.
     */
    cl = clnt_create(server, DIRPROG,
        DIRVERS, "tcp");
    if (clnt == (CLIENT *)NULL) {
        clnt_pcreateerror(server);
        exit(1);
    }
    result = readdir_1(&dir, clnt);
    if (result == (readdir_res *)NULL) {
        clnt_perror(clnt, server);
        exit(1);
    }
    /* Okay, we successfully called
     * the remote procedure.
     */
    if (result->errno != 0) {
        /* Remote system error. Print
         * error message and die.
         */
        errno = result->errno;
        perror(dir);
        exit(1);
    }
    /* Successfully got a directory listing.

```

(continued)

(Continuation)

```
* Print it.
*/
for (nl = result->readdir_res_u.list;
     nl != NULL;
     nl = nl->next) {
    printf("%s\n", nl->name);
}
xdr_free(xdr_readdir_res, result);
clnt_destroy(cl);
exit(0);
}
```

As in other examples, execution is on systems named `local` and `remote`. The files are compiled and run as follows:

```
remote$ rpcgen dir.x
remote$ cc -c dir_xdr.c
remote$ cc rls.c dir_clnt.c dir_xdr.o -o rls -lnsl
remote$ cc dir_svc.c dir_proc.c dir_xdr.o -o dir_svc -lnsl
remote$ dir_svc
```

When you install `rls()` on system `local`, you can list the contents of `/usr/share/lib` on system `remote` as follows:

```
local$ rls remote /usr/share/lib
ascii
eqnchar
greek
kbd
marg8
tblclr
tabs
tabs4
local$
```

`rpcgen` generated client code does not release the memory allocated for the results of the RPC call. Call `xdr_free()` to release the memory when you are finished with it. It is similar to calling the `free()` routine, except that you pass the XDR routine for the result. In this example, after printing the list, `xdr_free(xdr_readdir_res, result);` was called.

Note - Use `xdr_free()` to release memory allocated by `malloc()`. Failure to use `xdr_free()` to release memory results in memory leaks.

Preprocessing Directives

`rpcgen` supports C and other preprocessing features. C preprocessing is performed on `rpcgen` input files before they are compiled. All standard C preprocessing directives are allowed in the `.x` source files. Depending on the type of output file being generated, five symbols are defined by `rpcgen`.

`rpcgen` provides an additional preprocessing feature: any line that begins with a percent sign (%) is passed directly to the output file, with no action on the line's content. Caution is required because `rpcgen` does not always place the lines where you intend. Check the output source file and, if needed, edit it.

TABLE 3-1 `rpcgen` Preprocessing Directives

Symbol	Use
<code>RPC_HDR</code>	Header file output
<code>RPC_XDR</code>	XDR routine output
<code>RPC_SVC</code>	Server stub output
<code>RPC_CLNT</code>	Client stub output
<code>RPC_TBL</code>	Index table output

Code Example 3-7 is a simple `rpcgen` example. Note the use of `rpcgen`'s pre-processing features.

CODE EXAMPLE 3-7 Time Protocol `rpcgen` Source

```
/*
 * time.x: Remote time protocol
 */
program TIMEPROG {
    version TIMEEVERS {
        unsigned int TIMEGET() = 1;
    } = 1;
} = 0x20000044;

#ifdef RPC_SVC
%int *
%timeget_1()
%{
% static int thetime;
%
% thetime = time(0);
% return (&thetime);
%}
```

```
#endif
```

cpp Directive

`rpcgen` supports C preprocessing features. `rpcgen` defaults to use `/usr/ccs/lib/cpp` as the C preprocessor. If that fails, `rpcgen` tries to use `/lib/cpp`. You may specify a library containing a different `cpp` to `rpcgen` with the `-Y` flag.

For example, if `/usr/local/bin/cpp` exists, you can specify it to `rpcgen` as follows:

```
rpcgen -Y /usr/local/bin test.x
```

Compile-Time Flags

This section describes the `rpcgen` options available at compile time. The following table summarizes the options which are discussed in this section.

TABLE 3-2 `rpcgen` Compile-time Flags

Option	Flag	Comments
Templates	<code>-a</code> , <code>-Sc</code> , <code>-Ss</code> , <code>-Sm</code>	See Table 3-3
C-style	<code>-N</code>	Also called Newstyle mode
ANSI C	<code>-C</code>	Often used with the <code>-N</code> option
MT-Safe code	<code>-M</code>	For use in multithreaded environments
MT Auto mode	<code>-A</code>	<code>-A</code> also turns on <code>-M</code> option
TS-RPC library	<code>-b</code>	TI-RPC library is default
<code>xdr_inline</code> count	<code>-i</code>	Uses 5 packed elements as default, but other number may be specified

Client and Server Templates

`rpcgen` generates sample code for the client and server sides. Use these options to generate the desired templates.

TABLE 3-3 `rpcgen` Template Selection Flags

Flag	Function
<code>-a</code>	Generate all template files
<code>-Sc</code>	Generate client-side template
<code>-Ss</code>	Generate server-side template
<code>-Sm</code>	Generate makefile template

The files can be used as guides or by filling in the missing parts. These files are in addition to the stubs generated.

A C-style mode server template is generated from the `add.x` source by the command:

```
rpcgen -N -Ss -o add_server_template.c add.x
```

The result is stored in the file `add_server_template.c`. A C-style mode, client template for the same `add.x` source is generated with the command line:

```
rpcgen -N -Sc -o add_client_template.c add.x
```

The result is stored in the file `add_client_template.c`. A make file template for the same `add.x` source is generated with the command line:

```
rpcgen -N -Sm -o mkfile_template add.x
```

The result is stored in the file `mkfile_template`. It can be used to compile the client and the server. If the `-a` flag is used as follows:

```
rpcgen -N -a add.x
```

`rpcgen` generates all three template files. The client template goes into `add_client.c`, the server template to `add_server.c`, and the makefile template to `makefile.a`. If any of these files already exists, `rpcgen` displays an error message and exits.

Note - When you generate template files, give them new names to avoid the files being overwritten the next time `rpcgen` is executed.

C-style Mode

Also called Newstyle mode, The `-N` flag causes `rpcgen` to produce code in which arguments are passed by value and multiple arguments are passed without a `struct`. These changes allow RPC code that is more like C and other high-level languages. For compatibility with existing programs and make files, the previous (standard) mode of argument passing is the default. The following examples demonstrate the new feature. The source modules for both modes, C-style and default, are given in Code Example 3-8 and in Code Example 3-9 respectively.

CODE EXAMPLE 3-8 C-style Mode Version of `add.x`

```
/*
 * This program contains a procedure
 * to add 2 numbers. It demonstrates
 * the C-style mode argument passing.
 * Note that add() has 2 arguments.
 */
program ADDPROG {          /* program number */
    version ADDVER {      /* version number */
        int add(int, int) = 1; /* procedure */
    } = 1;
} = 0x20000199;
```

CODE EXAMPLE 3-9 Default Mode Version of `add.x`

```
/*
 * This program contains a procedure
 * to add 2 numbers. It demonstrates
 * the "default" mode argument passing.
 * In this mode rpcgen can process
 * only one argument.
 */
struct add_arg {
    int first;
    int second;
};
program ADDPROG {          /* program number */
    version ADDVER {      /* version number */
        int add (add_arg) = 1; /* procedure */
    } = 1;
} = 0x20000199;
```

The next four figures show the resulting client-side templates.

CODE EXAMPLE 3-10 C-style Mode Client Stub for add.x

```
/*
 * The C-style client side main
 * routine calls the add() function
 * on the remote rpc server
 */
#include <stdio.h>
#include "add.h"

main(argc, argv)
int argc;
char *argv[];
{
    CLIENT *clnt;
    int *result,x,y;

    if(argc != 4) {
        printf("usage: %s host num1
            num2\n" argv[0]);
        exit(1);
    }
    /* create client handle -
     * bind to server
     */
    clnt = clnt_create(argv[1], ADDPROG,
        ADDVER, "udp");
    if (clnt == NULL) {
        clnt_pcreateerror(argv[1]);
        exit(1);
    }
    x = atoi(argv[2]);
    y = atoi(argv[3]);
    /*
     * invoke remote procedure: Note that
     * multiple arguments can be passed to
     * add_l() instead of a pointer
     */
    result = add_l(x, y, clnt);
    if (result == (int *) NULL) {
        clnt_perror(clnt, "call failed:");
        exit(1);
    } else {
        printf("Success: %d + %d = %d\n",
            x, y, *result);
    }
    exit(0);
}
```

Code Example 3-11 shows how the default mode code differs from C-style mode code.

CODE EXAMPLE 3-11 Default Mode Client

```
arg.first = atoi(argv[2]);
arg.second = atoi(argv[3]);
/*
 * invoke remote procedure -- note
 * that a pointer to the argument has
 * to be passed to the client stub
 */
result = add_1(&arg, clnt);
```

The server-side procedure in C-style mode is shown in Code Example 3-12.

CODE EXAMPLE 3-12 C-style Mode Server

```
#include "add.h"

int *
add_1(arg1, arg2, rqstp)
    int arg1;
    int arg2;
    struct svc_req *rqstp;
{
    static int result;

    result = arg1 + arg2;
    return(&result);
}
```

The server side procedure in default mode is shown in Code Example 3-13.

CODE EXAMPLE 3-13 Default Mode Server Stub

```
#include "add.h"
int *
add_1(argp, rqstp)
    add_arg *argp;
    struct svc_req *rqstp;
{
    static int result;

    result = argp->first + argp->second;
    return(&result);
}
```

MT-Safe Code

By default, the code generated by `rpcgen` is not MT safe. It uses unprotected global variables and returns results in the form of static variables. The `-M` flag generates MT-safe code which can be used in a multithreaded environment. This can be used with the C-style flag, the ANSI C flag, or both.

An example of an MT-safe program with this interface follows. The `rpcgen` protocol file is `msg.x`, shown in Code Example 3-14.

CODE EXAMPLE 3-14 MT-Safe Program: `msg`.

```
program MESSAGEPROG {
version PRINTMESSAGE {
    int PRINTMESSAGE(string) = 1;
    } = 1;
} = 0x4001;
```

A string is passed to the remote procedure, which prints it and returns the length of the string to the client. The MT-Safe stubs are generated with:

```
% rpcgen -M msg.x
```

A possible client-side code that could be used with this is shown in Code Example 3-15.

CODE EXAMPLE 3-15 MT-Safe Client Stub

```
#include "msg.h"

void
messageprog_1(host)
char *host;
{
    CLIENT *clnt;
    enum clnt_stat retval_1;
    int result_1;
    char * printmessage_1_arg;

    clnt = clnt_create(host, MESSAGEPROG,
        PRINTMESSAGE,
        "netpath");
    if (clnt == (CLIENT *) NULL) {
        clnt_pcreateerror(host);
        exit(1);
    }
    printmessage_1_arg =
        (char *) malloc(256);
    strcpy(printmessage_1_arg, "Hello World");

    retval_1 = printmessage_1(&printmessage_1_arg,
        &result_1, clnt);
    if (retval_1 != RPC_SUCCESS) {
        clnt_perror(clnt, "call failed");
    }
    printf("result = %d\n", result_1);

    clnt_destroy(clnt);
}

main(argc, argv)
```

(continued)

(Continuation)

```
int argc;
char *argv[];
{
    char *host;

    if (argc < 2) {
        printf("usage: %s server_host\n", argv[0]);
        exit(1);
    }
    host = argv[1];
    messageprog_1(host);
}
```

Note that a pointer to both the arguments and the results needs to be passed in to the `rpcgen`-generated code. This is to preserve reentrancy. The value returned by the stub function indicates whether this call is a success or a failure. The stub returns `RPC_SUCCESS` if the call is successful. Compare the MT-safe client stub (generated with the `-M` option) and the not MT-safe client stub shown in Code Example 3-16. The client stub that is not MT safe uses a static to store returned results and can use only one thread at a time.

CODE EXAMPLE 3-16 Client Stub (Not MT Safe)

```
int *
printmessage_1(argp, clnt)
    char **argp;
    CLIENT *clnt;
{
    static int clnt_res;
    memset((char *)&clnt_res, 0,
           sizeof (clnt_res));
    if (clnt_call(clnt, PRINTMESSAGE,
                 (xdrproc_t) xdr_wrapstring,
                 (caddr_t) argp,
                 (xdrproc_t) xdr_int, (caddr_t)
                 &clnt_res,
                 TIMEOUT) != RPC_SUCCESS) {
        return (NULL);
    }
    return (&clnt_res);
}
```

The server side code is shown in Code Example 3-17.

Note - When compiling a server that uses MT-safe mode, you must link in the threads library. To do this, specify the `-lthread` option in the compile command.

CODE EXAMPLE 3-17 MT-Safe Server Stub

```
#include "msg.h"
#include <syslog.h>

bool_t
printmessage_1_svc(argp, result, rqstp)
char **argp;
int *result;
struct svc_req *rqstp;
{
    int retval;

    if (*argp == NULL) {
        syslog(LOG_INFO, "argp is NULL\n");
        *result = 0;
    }
    else {
        syslog("argp is %s\n", *argp);
        *result = strlen (*argp);
    }
    retval = 1;
    return (retval);
}

int
messageprog_1_freeresult(transp, xdr_result, result)
SVCXPRT *transp;
xdrproc_t xdr_result;
caddr_t result;
{
    /*
     * Insert additional freeing code here,
     * if needed
     */
    (void) xdr_free(xdr_result, result);
}
```

The server side code should not use statics to store returned results. A pointer to the result is passed in and this should be used to pass the result back to the calling routine. A return value of 1 indicates success to the calling routine, while 0 indicates a failure.

In addition, the code generated by `rpcgen` also generates a call to a routine to free any memory that may have been allocated when the procedure was called. To prevent memory leaks, any memory allocated in the service routine needs to be freed in this routine. `messageprog_1_freeresult()` frees the memory.

Normally, `xdr_free()` frees any allocated memory for you (in this case, no memory was allocated, so no freeing needs to take place).

As an example of the use of the `-M` flag with the C-style and ANSI C flag, consider the following file, `add.x`, shown in Code Example 3-18.

CODE EXAMPLE 3-18 MT-Safe Program: `add.x`

```
program ADDPROG {
  version ADDVER {
    int add(int, int) = 1;
  } = 1;
}= 199;
```

This program adds two numbers and returns its result to the client. `rpcgen` is invoked on it, with the following command: `% rpcgen -N -M -C add.x` The multithreaded client code to call this is shown in Code Example 3-19.

CODE EXAMPLE 3-19 MT-Safe Client: `add.x`

```
/*
 * This client-side main routine
 * starts up a number of threads,
 * each of which calls the server
 * concurrently.
 */

#include "add.h"

CLIENT *clnt;
#define NUMCLIENTS 5
struct argrec {
  int arg1;
  int arg2;
};

/* Keeps count of number of
 * threads running
 */
int numrunning;
mutex_t numrun_lock;
cond_t condnum;

void
addprog(struct argrec *args)
{
  enum clnt_stat retval;
  int result;
  /* call server code */
  retval = add_1(args->arg1, args->arg2,
                &result, clnt);
  if (retval != RPC_SUCCESS) {
    clnt_perror(clnt, "call failed");
  } else
```

(continued)

(Continuation)

```
    printf("thread #%x call succeeded,\n", thr_getself(),\n          result);\n    /* decrement the number of running\n    * threads\n    */\n    mutex_lock(&numrun_lock);\n    numrunning--;\n    cond_signal(&condnum);\n    mutex_unlock(&numrun_lock);\n    thr_exit(NULL);\n}\n\nmain(int argc, char *argv[])\n{\n    char *host;\n    struct argrec args[NUMCLIENTS];\n    int i;\n    thread_t mt;\n    int ret;\n\n    if (argc < 2) {\n        printf("usage:  %s server_host\\n",\n              argv[0]);\n        exit(1);\n    }\n    host = argv[1];\n    clnt = clnt_create(host, ADDPROG, ADDVER,\n                      "netpath");\n    if (clnt == (CLIENT *) NULL) {\n        clnt_pcreateerror(host);\n        exit(1);\n    };\n    mutex_init(&numrun_lock, USYNC_THREAD, NULL);\n    cond_init(&condnum, USYNC_THREAD, NULL);\n    numrunning = 0;\n\n    /* Start up separate threads */\n    for (i = 0; i < NUMCLIENTS; i++) {\n        args[i].arg1 = i;\n        args[i].arg2 = i + 1;\n        ret = thr_create(NULL, NULL, addprog,\n                        (char *) &args[i],\n                        THR_NEW_LWP, &mt);\n        if (ret == 0)\n            numrunning++;\n    }\n\n    mutex_lock(&numrun_lock);\n    /* are any threads still running ? */\n    while (numrunning != 0)\n        cond_wait(&condnum, &numrun_lock);\n}
```

(continued)

(Continuation)

```
mutex_unlock(&numrun_lock);
clnt_destroy(clnt);
}
```

The server-side procedure is shown in Code Example 3-20.

Note - When compiling a server that uses MT-safe mode, you must link in the threads library. To do this, specify the `-lthread` option in the compile command.

CODE EXAMPLE 3-20 MT-Safe Server: `add.x`

```
add_l_svc(int arg1, int arg2,
         int *result, struct svc_req *rqstp)
{
    bool_t retval;
    /* Compute result */
    *result = arg1 + arg2;
    retval = 1;
    return (retval);
}

/* Routine for freeing memory that may
 * be allocated in the server procedure
 */
int
addprog_l_freeresult(SVCXPRT *transp,
                    xdrproc_t xdr_result,
                    caddr_t result)
{
    (void) xdr_free(xdr_result, result);
}
```

MT Auto Mode

MT Auto mode enables RPC servers to automatically use Solaris threads to process client requests concurrently. Use the `-A` option to generate RPC code in MT Auto mode. The `-A` option also has the effect of turning on the `-M` option, so `-M` does not need to be explicitly specified. The `-M` option is necessary because any code generated has to be multithread safe.

Further discussion on multithreaded RPC begins on “Multithreaded RPC Programming” on page 136; see also “MT Auto Mode” on page 143.

Here is an example of an Auto mode program generated by `rpcgen`. The `rpcgen` protocol file `time.x` is shown in Code Example 3-21. A string is passed to the remote procedure, which prints it and returns the length of the string to the client. The MT-safe stubs are generated with:

CODE EXAMPLE 3-21 MT Auto Mode: `time.x`

```
program TIMEPROG {
    version TIMEEVERS {
        unsigned int TIMEGET(void) = 1;
        void TIMESET(unsigned) = 2;
    } = 1;
} = 0x20000044;
```

```
% rpcgen -A time.x
```

Note - When the `-A` option is used, the generated server code will contain instructions for enabling MT Auto mode for the server.

When compiling a server that uses MT Auto mode, you must link in the threads library. To do this, specify the `-lthread` option in the compile command.

TI-RPC or TS-RPC Library Selection

In older SunOS releases, `rpcgen` created stubs that used the socket functions. With the current SunOS release, you can use either the transport-independent RPC (TI-RPC) or the transport-specific socket (TS-RPC) routines. This provides backward compatibility with previous releases. The default uses the TI-RPC interfaces. The `-b` flag tells `rpcgen` to create TS-RPC variant source code as its output.

ANSI C-compliant Code

`rpcgen` can also produce output that is compatible with ANSI C or Sun WorkShop(TM) Compilers C++. This feature is selected with the `-C` compile flag and is most often used with the `-N` flag, described in “C-style Mode” on page 58.

The `add.x` example of the server template is generated by the command:

```
rpcgen -N -C -Ss -o add_server_template.c add.x
```

It is important to note that on the C++ 3.0 server, remote procedure names require an `_svc` suffix. In the following example, the `add.x` template and the `-C` compile flag produce the client side `add_1` and the server stub `add_1_svc`.

CODE EXAMPLE 3-22 rpcgen ANSI C Server Template

```
/*
 * This is a template. Use it to
 * develop your own functions.
 */
#include <c_varieties.h>
#include "add.h"

int *
add_l_svc(int arg1, int arg2,
          struct svc_req *rqstp)
{
    static int result;
    /*
     * insert server code here
     */
    return(&result);
}
```

This output conforms to the syntax requirements and structure of ANSI C. The header files that are generated when this option is invoked can be used with ANSI C or with C++

xdr_inline() Count

rpcgen tries to generate more efficient code by using `xdr_inline()` when possible (see the `xdr_admin(3NSL)` man page). When a structure contains elements that `xdr_inline()` can be used on (for example `integer`, `long`, `bool`), the relevant portion of the structure is packed with `xdr_inline()`. A default of five or more packed elements in sequence causes in-line code to be generated. This default can be changed with the `-i` flag. For example:

```
rpcgen -i 3 test.x
```

causes `rpcgen` to start generating in-line code after three qualifying elements are found in sequence. The example:

```
rpcgen -i 0 test.x
```

prevents any in-line code from being generated.

In most situations, there is no reason to use the `-i` flag. The `_xdr.c` stub is the only file affected by this feature.

rpcgen Programming Techniques

This section suggests some common RPC and `rpcgen` programming techniques. Each topic is covered in its own subsection.

- Network Type

`rpcgen` can produce server code for specific transport types.
- Define Statements

C-preprocessing symbols can be defined on `rpcgen` command lines.
- Broadcast Calls

Servers need not send error replies to broadcast calls.
- Debugging Applications

Debug as normal function calls, then change to a distributed application.
- Port Monitor Support

Port monitors can “listen” on behalf of RPC servers.
- Dispatch Tables

Programs can access server dispatch tables.
- Time-out Changes

Client default time-out periods can be changed.
- Authentication

Clients may authenticate themselves to servers; interested servers can examine client authentication information.

Network Types/Transport Selection

`rpcgen` takes optional arguments that allow a programmer to specify desired network types or specific network identifiers. (For details of network selection, see *Transport Interfaces Programming Guide*).

The `-s` flag creates a server that responds to requests on the specified type of transport. For example, the invocation

```
rpcgen -s datagram_n prot.x
```

writes a server to standard output that responds to any of the connectionless transports specified in the `NETPATH` environment variable (or in `/etc/netconfig`, if `NETPATH` is not defined). A command line can contain multiple `-s` flags and their network types.

Similarly, the `-n` flag creates a server that responds only to requests from the transport specified by a single network identifier.



Caution - Be careful using servers created by `rpcgen` with the `-n` flag. Network identifiers are host specific, so the resulting server may not run as expected on other hosts.

Command Line Define Statements

You can define C-preprocessing symbols and assign values to them from the command line. Command line define statements can, for example, be used to generate conditional debugging code when the `DEBUG` symbol is defined. For example:

```
$ rpcgen -DDEBUG proto.x
```

Server Response to Broadcast Calls

When a procedure has been called through broadcast RPC and cannot provide a useful response, the server should send no reply to the client. This reduces network traffic. To prevent the server from replying, a remote procedure can return `NULL` as its result. The server code generated by `rpcgen` detects this and sends no reply.

Code Example 3-23 is a procedure that replies only if it is an NFS server.

CODE EXAMPLE 3-23 NFS Server Response to Broadcast Calls

```
void *
reply_if_nfsserver()
{
    char notnull; /*only here so we can
                  *use its address
                  */

    if( access( "/etc/dfs/sharetab",
               F_OK ) < 0 ) {
        /* prevent RPC from replying */
        return( (void *) NULL );
    }
    /* assign notnull a non-null value
     * so RPC will send a reply
     */
    return( (void *) &notnull );
}
```

A procedure *must* return a non-`NULL` pointer when it wants RPC library routines to send a reply.

In Code Example 3-23, if the procedure `reply_if_nfsserver()` is defined to return non void values, the return value (`¬null`) should point to a static variable.

Port Monitor Support

Port monitors such as `inetd` and `listen` can monitor network addresses for specified RPC services. When a request arrives for a particular service, the port monitor spawns a server process. After the call has been serviced, the server can exit. This technique conserves system resources. The main server function generated by `rpcgen` allows invocation by `inetd`. See “Using `inetd`” on page 131 for details.

It may be useful for services to wait for a specified interval after satisfying a service request, in case another request follows. If there is no call in the specified time, the server exits, and some port monitors, like `inetd`, continue to monitor for the server. If a later request for the service occurs, the port monitor gives the request to a waiting server process (if any), rather than spawning a new process.

Note - When monitoring for a server, some port monitors, like `listen()`, always spawn a new process in response to a service request. If a server is used with such a monitor, it should exit immediately on completion.

By default, services created using `rpcgen` wait for 120 seconds after servicing a request before exiting. The programmer can change the interval with the `-K` flag. In this example,

```
$ rpcgen -K 20 proto.x
```

the server waits for 20 seconds before exiting. To create a server that exits immediately, zero value can be used for the interval period:

```
$ rpcgen -K 0 proto.x.
```

To create a server that never exits, the value is `-K -1`.

Time-out Changes

After sending a request to the server, a client program waits for a default period (25 seconds) to receive a reply. This time-out may be changed using the `clnt_control()` routine. See “Standard Interfaces” on page 86 for additional uses of the `clnt_control()` routine. See also the `rpc(3N)` manpage. When considering time-out periods, be sure to allow the minimum amount of time required for “round-trip” communications over the network. Code Example 3-24 illustrates the use of `clnt_control()`.

CODE EXAMPLE 3-24 `clnt_control` Routine

```
struct timeval tv;
CLIENT *clnt;
clnt = clnt_create( "somehost", SOMEPROG,
                  SOMEVERS, "visible" );
```

```

if (clnt == (CLIENT *)NULL)
    exit(1);
tv.tv_sec = 60; /* change time-out to
    * 60 seconds
    */
tv.tv_usec = 0;
clnt_control(clnt, CLSET_TIMEOUT, &tv);

```

Client Authentication

The client create routines do not have any facilities for client authentication. Some clients may have to authenticate themselves to the server.

The following example illustrates one of the least secure authentication methods in common use. See “Authentication” on page 111 for information on more secure authentication techniques.

CODE EXAMPLE 3-25 AUTH_SYS Authentication Program

```

CLIENT *clnt;
clnt = clnt_create( "somehost", SOMEPROG,
    SOMEVERS, "visible" );
if (clnt != (CLIENT *)NULL) {
    /* To set AUTH_SYS style authentication */
    clnt->cl_auth = authsys_createdefault();
}

```

Authentication information is important to servers that have to achieve some level of security. This extra information is supplied to the server as a second argument.

Code Example 3-26 is a server that checks client authentication data. It is modified from `printmessage_1()` in “An rpcgen Tutorial” on page 43 and only allows superusers to print a message to the console.

CODE EXAMPLE 3-26 `printmsg_1` for Superuser

```

int *
printmessage_1(msg, req)
    char **msg;
    struct svc_req *req;
{
    static int result; /* Must be static */
    FILE *f;
    struct authsys_parms *aup;

    aup = (struct authsys_parms *)req->rq_clntcred;
    if (aup->aup_uid != 0) {
        result = 0;
        return (&result)
    }

    /* Same code as before. */
}

```

Dispatch Tables

It is sometimes useful for programs to have access to dispatch tables used by the RPC package. For example, the server dispatch routine may check authorization and then invoke the service routine; or a client library may deal with the details of storage management and XDR data conversion.

When invoked with the `-T` option, `rpcgen` generates RPC dispatch tables for each program defined in the protocol description file, `proto.x`, in the file `proto_tbl.i`. The suffix `.i` stands for “index.” `rpcgen` may be invoked with the `-t` option to build only the header file. `rpcgen` cannot be invoked in C-style mode (`-N`) with either the `-T` or `-t` flag.

Each entry in the dispatch table is a struct `rpcgen_table`, defined in the header file `proto.h` as follows:

```
struct rpcgen_table {
    char *(*proc)();
    xdrproc_t xdr_arg;
    unsigned len_arg;
    xdrproc_t xdr_res;
    xdrproc_t len_res;
};
```

where:

proc is a pointer to the service routine

xdr_arg is a pointer to the input (argument) xdr routine

len_arg is the length in bytes of the input argument

xdr_res is a pointer to the output (result) xdr routine

len_res is the length in bytes of the output result

The table, named `dirprog_1_table` for the `dir.x` example, is indexed by procedure number. The variable `dirprog_1_nproc` contains the number of entries in the table.

An example of how to locate a procedure in the dispatch tables is shown by the routine `find_proc()`:

CODE EXAMPLE 3-27 Using a Dispatch Table

```
struct rpcgen_table *
find_proc(proc)
    rpcproc_t proc;
{
    if (proc >= dirprog_1_nproc)
        /* error */
    else
        return (&dirprog_1_table[proc]);
}
```

Each entry in the dispatch table contains a pointer to the corresponding service routine. However, that service routine is usually not defined in the client code. To avoid generating unresolved external references, and to require only one source file for the dispatch table, the `rpcgen` service routine initializer is `RPCGEN_ACTION(proc_ver)`.

This way, the same dispatch table can be included in both the client and the server. Use the following define statement when compiling the client:

```
#define RPCGEN_ACTION(routine) 0
```

And use the following define when writing the server:

```
#define RPCGEN_ACTION(routine)routine
```

64-bit Considerations for `rpcgen`

Note that in Code Example 3-27 `proc` is declared as type `rpcproc_t`. Formerly, RPC programs, versions, procedures, and ports were declared to be of type `u_long`. On a 32-bit machine, a `u_long` is a four-byte quantity (as is an `int`); on a 64-bit system, a `u_long` is an eight-byte quantity. The data types `rpcprog_t`, `rpcvers_t`, `rpc_proc_t`, and `rpcport_t` – introduced in Solaris 7 – should be used whenever possible in declaring RPC programs, versions, procedures, and ports in place of both `u_long` and `long`. The reason is that these newer types provide backwards compatibility with 32-bit systems; they're guaranteed to be four-byte quantities no matter which system `rpcgen` is run on. While `rpcgen` programs using `u_long` versions of programs, versions, and procedures will still run, they may have different consequences on 32- and 64-bit machines. For that reason it is a good idea to replace them with the appropriate newer data types. In fact, it is a good idea to avoid using `long` and `u_long` whenever possible (see the note below).

Beginning with Solaris 7, source files created by `rpcgen`, containing XDR routines, use different inline macros depending on whether the code is to run on a 32- or 64-bit machine – specifically, it uses the `IXDR_GET_INT32()` and `IXDR_PUT_INT32()` macros instead of `IXDR_GETLONG()` and `IXDR_PUTLONG()`. For example, if the `rpcgen` source file `foo.x` contains the following code

```
struct foo {
    char    c;
    int     i1;
    int     i2;
    int     i3;
    long    l;
    short   s;
};
```

the resulting `foo_xdr.c` file will ensure that the correct inline macro is used:

```
#if defined(_LP64) || defined(_KERNEL)
    register int *buf;
#else
    register long *buf;
#endif
```

```

. . .
#if defined(_LP64) || defined(_KERNEL)
    IXDR_PUT_INT32(buf, objp->i1);
    IXDR_PUT_INT32(buf, objp->i2);
    IXDR_PUT_INT32(buf, objp->i3);
    IXDR_PUT_INT32(buf, objp->l);
    IXDR_PUT_SHORT(buf, objp->s);
#else
    IXDR_PUT_LONG(buf, objp->i1);
    IXDR_PUT_LONG(buf, objp->i2);
    IXDR_PUT_LONG(buf, objp->i3);
    IXDR_PUT_LONG(buf, objp->l);
    IXDR_PUT_SHORT(buf, objp->s);
#endif

```

Note that the code declares *buf* to be either `int` or `long`, depending on whether the machine is 64- or 32-bit.

Note - Currently, data types transported via RPC are limited in size to four-byte quantities (32 bits). The eight-byte `long` is provided to allow applications to make maximum use of 64-bit architecture. However, programmers should avoid using `longs`, and functions that use `longs`, such as `x_putlong()`, in favor of `ints` whenever possible. (As noted above, RPC programs, versions, procedures, and ports have their own dedicated types.) The reason is that `xdr_long()` will fail if the data value is not between `INT32_MIN` and `INT32_MAX` - or the data could be truncated if inline macros such as `IXDR_GET_LONG()` and `IXDR_PUT_LONG()` are used. (The same applies for `u_long`s.) See also the `xdr_long(3NSL)` man page.

IPv6 Considerations for RPCGEN

Only TI-RPC supports IPv6 transport. If an application is intended to run over IPv6, now or in the future, then the backward compatibility switch must not be used. The selection of IPv4 or IPv6 is determined by the respective order of associated entries in `/etc/netconfig`.

Debugging Applications

You can simplify the testing and debugging process. First test the client program and the server procedure in a single process by linking them with each other rather than with the client and server skeletons. Comment out calls to the client create RPC library routines (see the `rpc_clnt_create(3N)` manpage) and the authentication routines. Do not link with `libnsl`.

Link the procedures from previous example by:

```
cc rls.c dir_clnt.c dir_proc.c -o rls
```

With the RPC and XDR functions commented out, the procedure calls execute as ordinary local function calls, and the program is debugged with a local debugger such as `dbxtool`. When the program works, the client program is linked to the client skeleton produced by `rpcgen` and the server procedures are linked to the server skeleton produced by `rpcgen`.

You can also use the Raw RPC mode to test the XDR routines. See “Testing Programs Using Low-level Raw RPC” on page 102 for details.

There are two kinds of errors that can happen in an RPC call. The first kind of error is caused by a problem with the mechanism of the remote procedure calls. Examples of these are (1) the procedure is not available, (2) the remote server is not responding, and (3) the remote server is unable to decode the arguments. In Code Example 3-26, an RPC error happens if `result` is `NULL`. The reason for the failure can be displayed by using `clnt_perror()`, or an error string can be returned through `clnt_spperror()`.

The second type of error is caused by the server itself. In Code Example 3-26, an error can be returned by `opendir()`. The handling of these errors is application specific and is the responsibility of the programmer.

Note that the mechanism illustrated by the paragraphs above does not function with the `-C` option because of the `_svc` suffix added to the server-side routines.

The Programmer's Interface to RPC

This section addresses the C interface to RPC and describes how to write network applications using RPC. For a complete specification of the routines in the RPC library, see the `rpc(3NSL)` and related man pages.

- “Simplified Interface” on page 78
- “Standard Interfaces” on page 86
- “Testing Programs Using Low-level Raw RPC” on page 102
- “Advanced RPC Programming Techniques” on page 104
- “Multithreaded RPC Programming” on page 136
- “MT Auto Mode” on page 143
- “MT User Mode” on page 146
- “Porting From TS-RPC to TI-RPC” on page 158

RPC Is Multithread Safe

The client and server interfaces described in this chapter are multithread safe, except where noted (such as raw mode). This means that applications that contain RPC function calls can be used freely in a multithreaded application.

Simplified Interface

The simplified interface is the easiest level to use because it does not require the use of any other RPC routines. It also limits control of the underlying communications mechanisms. Program development at this level can be rapid, and is directly supported by the `rpcgen` compiler. For most applications, `rpcgen` and its facilities are sufficient.

Some RPC services are not available as C functions, but they are available as RPC programs. The simplified interface library routines provide direct access to the RPC facilities for programs that do not require fine levels of control. Routines such as `rusers()` are in the RPC services library `librpcsvc`. Code Example 4-1 is a program that displays the number of users on a remote host. It calls the RPC library routine, `rusers()`.

CODE EXAMPLE 4-1 `rusers` Program

```
#include <rpc/rpc.h>
#include <rpcsvc/rusers.h>
#include <stdio.h>

/*
 * a program that calls the
 * rusers() service
 */

main(argc, argv)
int argc;
char **argv;
{
    int num;

    if (argc != 2) {
        fprintf(stderr, "usage: %s hostname\n",
            argv[0]);
        exit(1);
    }
    if ((num = rusers(argv[1])) < 0) {
        fprintf(stderr, "error: rusers\n");
        exit(1);
    }
    fprintf(stderr, "%d users on %s\n", num,
        argv[1] );
    exit(0);
}
```

Compile the program in Code Example 4-1 with:

```
cc program.c -lrpcsvc -lnsl
```

Client

There is just one function on the client side of the simplified interface: `rpc_call()`. It has nine parameters:

```
int 0 or error code
rpc_call (
    char    *host    /* Name of server host */
    rpcprog_t  prognum /* Server program number */
    rpcvers_t  versnum /* Server version number */
    rpcproc_t  procnum /* Server procedure number */
    xdrproc_t  inproc /* XDR filter to encode arg */
    char    *in    /* Pointer to argument */
    xdr_proc_t outproc /* Filter to decode result */
    char    *out    /* Address to store result */
    char    *nettype /* For transport selection */
);
```

This function calls the procedure specified by *prognum*, *versum*, and *procnum* on the *host*. The argument to be passed to the remote procedure is pointed to by the *in* parameter, and *inproc* is the XDR filter to encode this argument. The *out* parameter is an address where the result from the remote procedure is to be placed. *outproc* is an XDR filter which will decode the result and place it at this address.

The client blocks on `rpc_call()` until it receives a reply from the server. If the server accepts, it returns `RPC_SUCCESS` with the value of zero. It will return a non-zero value if the call was unsuccessful. This value can be cast to the type `clnt_stat`, an enumerated type defined in the RPC include files and interpreted by the `clnt_sperrno()` function. This function returns a pointer to a standard RPC error message corresponding to the error code.

In the example, all “visible” transports listed in `/etc/netconfig` are tried. Adjusting the number of retries requires use of the lower levels of the RPC library.

Multiple arguments and results are handled by collecting them in structures.

The example in Code Example 4-1, changed to use the simplified interface, looks like Code Example 4-2.

CODE EXAMPLE 4-2 rusers Program Using Simplified Interface

```
#include <stdio.h>
#include <utmpx.h>
#include <rpc/rpc.h>
#include <rpcsvc/rusers.h>

/* a program that calls the RUSERSPROG
 * RPC program
 */
```

(continued)

(Continuation)

```
main(argc, argv)
int argc;
char **argv;
{
    unsigned int nusers;
    enum clnt_stat cs;

    if (argc != 2) {
        fprintf(stderr, "usage: rusers hostname\n");
        exit(1);
    }
    if( cs = rpc_call(argv[1], RUSERSPROG,
        RUSERSVERS, RUSERSPROC_NUM, xdr_void,
        (char *)0, xdr_u_int, (char *)&nusers,
        "visible" ) != RPC_SUCCESS ) {
        clnt_perrno(cs);
        exit(1);
    }
    fprintf(stderr, "%d users on %s\n", nusers,
        argv[1] );
    exit(0);
}
```

Since data types may be represented differently on different machines, `rpc_call()` needs both the type of, and a pointer to, the RPC argument (similarly for the result). For `RUSERSPROC_NUM`, the return value is an unsigned int, so the first return parameter of `rpc_call()` is `xdr_u_int` (which is for an unsigned int) and the second is `&nusers` (which points to unsigned int storage). Because `RUSERSPROC_NUM` has no argument, the XDR encoding function of `rpc_call()` is `xdr_void()` and its argument is `NULL`.

Server

The server program using the simplified interface is very straightforward. It simply calls `rpc_reg()` to register the procedure to be called, and then it calls `svc_run()`, the RPC library's remote procedure dispatcher, to wait for requests to come in.

`rpc_reg()` has the following arguments:

```
rpc_reg (
    rpcprog_t   prognum    /* Server program number */
    rpcvers_t   versnum    /* Server version number */
    rpcproc_t   procnum    /* server procedure number */
    char        *procname  /* Name of remote function */
    xdrproc_t   inproc     /* Filter to encode arg */
    xdrproc_t   outproc    /* Filter to decode result */
```



```

        char      *nettype    /* For transport selection */
    );

```

`svc_run()` invokes service procedures in response to RPC call messages. The dispatcher in `rpc_reg()` takes care of decoding remote procedure arguments and encoding results, using the XDR filters specified when the remote procedure was registered. Some notes about the server program:

- Most RPC applications follow the naming convention of appending a `_1` to the function name. The sequence `_n` is added to the procedure names to indicate the version number `n` of the service.
- The argument and result are passed as addresses. This is true for all functions that are called remotely. If you pass `NULL` as a result of a function, then no reply is sent to the client. It is assumed that there is no reply to send.
- The result must exist in static data space because its value is accessed after the actual procedure has exited. The RPC library function that builds the RPC reply message accesses the result and sends the value back to the client.
- Only a single argument is allowed. If there are multiple elements of data, they should be wrapped inside a structure which can then be passed as a single entity.
- The procedure is registered for each transport of the specified type. If the type parameter is `(char *)NULL`, the procedure is registered for all transports specified in `NETPATH`.

Hand-Coded Registration Routine

You can sometimes implement faster or more compact code than can `rpcgen`. `rpcgen` handles the generic code-generation cases. The following program is an example of a hand-coded registration routine. It registers a single procedure and enters `svc_run()` to service requests.

```

#include <stdio.h>
#include <rpc/rpc.h>
#include <rpcsvc/rusers.h>
void *rusers();

main()
{
    if(rpc_reg(RUSERSPROG, RUSERSVERS,
              RUSERSPROC_NUM, rusers,
              xdr_void, xdr_u_int,
              "visible") == -1) {
        fprintf(stderr, "Couldn't Register\n");
        exit(1);
    }
    svc_run();    /* Never returns */
}

```

(continued)

(Continuation)

```
fprintf(stderr, "Error: svc_run
         returned!\n");
exit(1);
}
```

`rpc_reg()` can be called as many times as is needed to register different programs, versions, and procedures.

Passing Arbitrary Data Types

Data types passed to and received from remote procedures can be any of a set of predefined types, or can be programmer-defined types. RPC handles arbitrary data structures, regardless of different machines' byte orders or structure layout conventions, by always converting them to a standard transfer format called external data representation (XDR) before sending them over the transport. The conversion from a machine representation to XDR is called serializing, and the reverse process is called deserializing.

The translator arguments of `rpc_call()` and `rpc_reg()` can specify an XDR primitive procedure, like `xdr_u_int()`, or a programmer-supplied routine that processes a complete argument structure. Argument processing routines must take only two arguments: a pointer to the result and a pointer to the XDR handle.

TABLE 4-1 XDR Primitive Type Routines

XDR Primitive Routines			
<code>xdr_int()</code>	<code>xdr_netobj()</code>	<code>xdr_u_long()</code>	<code>xdr_enum()</code>
<code>xdr_long()</code>	<code>xdr_float()</code>	<code>xdr_u_int()</code>	<code>xdr_bool()</code>
<code>xdr_short()</code>	<code>xdr_double()</code>	<code>xdr_u_short()</code>	<code>xdr_wrapstring()</code>
<code>xdr_char()</code>	<code>xdr_quadruple()</code>	<code>xdr_u_char()</code>	<code>xdr_void()</code>
<code>xdr_hyper()</code>	<code>xdr_u_hyper()</code>		

For the convenience of ANSI C programmers who are accustomed to the fixed-width integer types found in `int_types.h`, the routines `xdr_char()`, `xdr_short()`, `xdr_int()`, and `xdr_hyper()` (and the unsigned versions of each) have equivalent functions with names familiar to ANSI C, as indicated in Table 4-2.

TABLE 4-2 Primitive Type Equivalences

Function	Equivalent
<code>xdr_char()</code>	<code>xdr_int8_t()</code>
<code>xdr_u_char()</code>	<code>xdr_u_int8_t()</code>
<code>xdr_short()</code>	<code>xdr_int16_t()</code>
<code>xdr_u_short()</code>	<code>xdr_u_int16_t()</code>
<code>xdr_int()</code>	<code>xdr_int32_t()</code>
<code>xdr_u_int()</code>	<code>xdr_u_int32_t()</code>
<code>xdr_hyper()</code>	<code>xdr_int64_t()</code>
<code>xdr_u_hyper()</code>	<code>xdr_u_int64_t()</code>

The nonprimitive `xdr_string()`, which takes more than two parameters, is called from `xdr_wrapstring()`.

For an example of a programmer-supplied routine, the structure:

```
struct simple {
    int a;
    short b;
} simple;
```

contains the calling arguments of a procedure. The XDR routine `xdr_simple()` translates the argument structure as shown in Code Example 4-3.

CODE EXAMPLE 4-3 `xdr_simple` Routine

```
#include <rpc/rpc.h>
#include "simple.h"
```

(Continuation)

```
bool_t
xdr_simple(xdrsp, simplep)
XDR *xdrsp;
struct simple *simplep;
{
  if (!xdr_int(xdrsp, &simplep->a))
    return (FALSE);
  if (!xdr_short(xdrsp, &simplep->b))
    return (FALSE);
  return (TRUE);
}
```

An equivalent routine can be generated automatically by `rpcgen`.

An XDR routine returns nonzero (a C `TRUE`) if it completes successfully, and zero otherwise. A complete description of XDR is provided in Appendix C.

TABLE 4-3

Prefabricated Routines

<code>xdr_array()</code>	<code>xdr_bytes()</code>	<code>xdr_reference()</code>
<code>xdr_vector()</code>	<code>xdr_union()</code>	<code>xdr_pointer()</code>
<code>xdr_string()</code>	<code>xdr_opaque()</code>	

For example, to send a variable-sized array of integers, it is packaged in a structure containing the array and its length:

```
struct varintarr {
  int *data;
  int arrlnth;
} arr;
```

Translate the array with `xdr_varintarr()`, as shown in Code Example 4-4.

CODE EXAMPLE 4-4 `xdr_varintarr` Syntax Use

```
bool_t
xdr_varintarr(xdrsp, arrp)
XDR *xdrsp;
struct varintarr *arrp;
{
  return(xdr_array(xdrsp, (caddr_t)&arrp->data,
```

```

    (u_int *)&arrp->arrlnth, MAXLEN,
    sizeof(int), xdr_int));
}

```

The arguments of `xdr_array()` are the XDR handle, a pointer to the array, a pointer to the size of the array, the maximum array size, the size of each array element, and a pointer to the XDR routine to translate each array element. If the size of the array is known in advance, use `xdr_vector()`, as shown in Code Example 4-5.

CODE EXAMPLE 4-5 `xdr_vector` Syntax Use

```

int intarr[SIZE];

bool_t
xdr_intarr(xdrsp, intarr)
    XDR *xdrsp;
    int intarr[];
{
    return (xdr_vector(xdrsp, intarr, SIZE,
        sizeof(int),
        xdr_int));
}

```

XDR converts quantities to 4-byte multiples when serializing. For arrays of characters, each character occupies 32 bits. `xdr_bytes()` packs characters. It has four parameters similar to the first four parameters of `xdr_array()`.

Null-terminated strings are translated by `xdr_string()`. It is like `xdr_bytes()` with no length parameter. On serializing it gets the string length from `strlen()`, and on deserializing it creates a null-terminated string.

Code Example 4-6 calls the built-in functions `xdr_string()` and `xdr_reference()`, which translates pointers to pass a string, and `struct simple` from the previous examples.

CODE EXAMPLE 4-6 `xdr_reference` Syntax Use

```

struct finalexample {
    char *string;
    struct simple *simplep;
} finalexample;

bool_t
xdr_finalexample(xdrsp, finalp)
    XDR *xdrsp;
    struct finalexample *finalp;
{
    if (!xdr_string(xdrsp, &finalp->string,
        MAXSTRLEN))
        return (FALSE);
    if (!xdr_reference(xdrsp, &finalp->simplep,
        sizeof(struct simple), xdr_simple))
        return (FALSE);
    return (TRUE);
}

```

```
}
```

Note that `xdr_simple()` could have been called here instead of `xdr_reference()`.

Standard Interfaces

Interfaces to standard levels of the RPC package provide increasing control over RPC communications. Programs that use this control are more complex. Effective programming at these lower levels requires more knowledge of computer network fundamentals. The top, intermediate, expert, and bottom levels are part of the standard interfaces.

This section shows how to control RPC details by using lower levels of the RPC library. For example, you can select the transport protocol, which can be done at the simplified interface level only through the `NETPATH` variable. You should be familiar with the TLI in order to use these routines.

The routines shown in Table 4-4 cannot be used through the simplified interface because they require a transport handle. For example, there is no way to allocate and free memory while serializing or deserializing with XDR routines at the simplified interface.

TABLE 4-4 XDR Routines Requiring a Transport Handle

Do Not Use With Simplified Interface		
<code>clnt_call()</code>	<code>clnt_destroy()</code>	<code>clnt_control()</code>
<code>clnt_perrno()</code>	<code>clnt_pcreateerror()</code>	<code>clnt_perror()</code>
<code>svc_destroy()</code>		

Top Level Interface

At the top level, the application can specify the type of transport to use but not the specific transport. This level differs from the simplified interface in that the application creates its own transport handles, in both the client and server.

Client

Assume the header file in Code Example 4-7.

CODE EXAMPLE 4-7 time_prot.h Header File

```
/* time_prot.h */
#include <rpc/rpc.h>
#include <rpc/types.h>

struct timev {
    int second;
    int minute;
    int hour;
};
typedef struct timev timev;
bool_t xdr_timev();

#define TIME_PROG 0x40000001
#define TIME_VERS 1
#define TIME_GET 1
```

Code Example 4-8 shows the client side of a trivial date service using top-level service routines. The transport type is specified as an invocation argument of the program.

CODE EXAMPLE 4-8 Client for Trivial Date Service

```
#include <stdio.h>
#include "time_prot.h"

#define TOTAL (30)
/*
 * Caller of trivial date service
 * usage: calltime hostname
 */
main(argc, argv)
    int argc;
    char *argv[];
{
    struct timeval time_out;
    CLIENT *client;
    enum clnt_stat stat;
    struct timev timev;
    char *nettype;

    if (argc != 2 && argc != 3) {
        fprintf(stderr, "usage:%s host[nettype]\n",
            argv[0]);
        exit(1);
    }
}
```

(continued)

(Continuation)

```
    }
    if (argc == 2)
        nettype = "netpath"; /* Default */
    else
        nettype = argv[2];
    client = clnt_create(argv[1], TIME_PROG,
                       TIME_VERS, nettype);
    if (client == (CLIENT *) NULL) {
        clnt_pcreateerror('`Couldn't create client`');
        exit(1);
    }
    time_out.tv_sec = TOTAL;
    time_out.tv_usec = 0;
    stat = clnt_call( client, TIME_GET,
                    xdr_void, (caddr_t) NULL,
                    xdr_timev, (caddr_t) &timev,
                    time_out);
    if (stat != RPC_SUCCESS) {
        clnt_perror(client, "Call failed");
        exit(1);
    }
    fprintf(stderr, "%s: %02d:%02d:%02d GMT\n",
           nettype, timev.hour, timev.minute,
           timev.second);
    (void) clnt_destroy(client);
    exit(0);
}
```

If *nettype* is not specified in the invocation of the program, the string *netpath* is substituted. When RPC libraries routines encounter this string, the value of the `NETPATH` environment variable governs transport selection.

If the client handle cannot be created, display the reason for the failure with `clnt_pcreateerror()`, or get the error status by reading the contents of the global variable *rpc_createerr*.

After the client handle is created, `clnt_call()` is used to make the remote call. Its arguments are the remote procedure number, an XDR filter for the input argument, the argument pointer, an XDR filter for the result, the result pointer, and the time-out period of the call. The program has no arguments, so `xdr_void()` is specified. Clean up by calling `clnt_destroy()`.

In the above example, if the programmer wished to bound the time allowed for client handle creation to thirty seconds, the call to `clnt_create()` should be replaced with a call to `clnt_create_timed()` as shown in the following code segment:

```
struct timeval timeout;
timeout.tv_sec = 30; /* 30 seconds */
timeout.tv_usec = 0;
```



```

client = clnt_create_timed(argv[1],
    TIME_PROG, TIME_VERS, nettype,
    &timeout);

```

Code Example 4-9 shows a top-level implementation of a server for the trivial date service.

CODE EXAMPLE 4-9 Server for Trivial Date Service

```

#include <stdio.h>
#include <rpc/rpc.h>
#include "time_prot.h"

static void time_prog();

main(argc,argv)
    int argc;
    char *argv[];
{
    int transpnum;
    char *nettype;

    if (argc > 2) {
        fprintf(stderr, "usage: %s [nettype]\n",
            argv[0]);
        exit(1);
    }
    if (argc == 2)
        nettype = argv[1];
    else
        nettype = "netpath"; /* Default */
    transpnum =
    svc_create(time_prog,TIME_PROG,TIME_VERS,nettype);
    if (transpnum == 0) {
        fprintf(stderr, "%s: cannot create %s service.\n",
            argv[0], nettype);
        exit(1);
    }
    svc_run();
}

/*
 * The server dispatch function
 */
static void
time_prog(rqstp, transp)
    struct svc_req *rqstp;
    SVCXPRT *transp;
{
    struct timev rslt;
    time_t thetime;

```

(continued)

(Continuation)

```
switch(rqstp->rq_proc) {
  case NULLPROC:
    svc_sendreply(transp, xdr_void, NULL);
    return;
  case TIME_GET:
    break;
  default:
    svcerr_noproc(transp);
    return;
}
thetime = time((time_t *) 0);
rslt.second = thetime % 60;
thetime /= 60;
rslt.minute = thetime % 60;
thetime /= 60;
rslt.hour = thetime % 24;
if (!svc_sendreply( transp, xdr_timev, &rslt)) {
  svcerr_systemerr(transp);
}
}
```

`svc_create()` returns the number of transports on which it created server handles. `time_prog()` is the service function called by `svc_run()` when a request specifies its program and version numbers. The server returns the results to the client through `svc_sendreply()`.

When `rpcgen` is used to generate the dispatch function, `svc_sendreply()` is called after the procedure returns, so `rslt` (in this example) must be declared `static` in the actual procedure. `svc_sendreply()` is called from inside the dispatch function, so `rslt` is not declared `static`.

In this example, the remote procedure takes no arguments. When arguments must be passed, the calls:

```
svc_getargs( SVCXPRT_handle, XDR_filter, argument_pointer);
svc_freeargs( SVCXPRT_handle, XDR_filter argument_pointer );
```

fetch, deserialize (XDR decode), and free the arguments.

Intermediate Level Interface

At the intermediate level, the application directly chooses the transport to use.

Client

Code Example 4-10 shows the client side of the time service from “Top Level Interface” on page 86, written at the intermediate level of RPC. In this example, the user must name the transport over which the call is made on the command line.

CODE EXAMPLE 4-10 Client for Time Service, Intermediate Level

```
#include <stdio.h>
#include <rpc/rpc.h>
#include <netconfig.h> /* For netconfig structure */
#include "time_prot.h"

#define TOTAL (30)

main(argc,argv)
int argc;
char *argv[];
{
    CLIENT *client;
    struct netconfig *nconf;
    char *netid;
    /* Declarations from previous example */

    if (argc != 3) {
        fprintf(stderr, "usage: %s host netid\n",
            argv[0]);
        exit(1);
    }
    netid = argv[2];
    if ((nconf = getnetconfig( netid)) ==
        (struct netconfig *) NULL) {
        fprintf(stderr, "Bad netid type: %s\n",
            netid);
        exit(1);
    }
    client = clnt_tp_create(argv[1], TIME_PROG,
        TIME_VERS, nconf);
    if (client == (CLIENT *) NULL) {
        clnt_pcreateerror("Could not create client");
        exit(1);
    }
    freenetconfig(nconf);

    /* Same as previous example after this point */
}
```

In this example, the `netconfig` structure is obtained by a call to `getnetconfig(netid)`. (See the `getnetconfig(3NSL)` man page and *Transport Interfaces Programming Guide* for more details.) At this level, the program explicitly selects the network.

In the above example, if the programmer wished to bound the time allowed for client handle creation to thirty seconds, the call to `clnt_tp_create()` should be replaced with a call to `clnt_tp_create_timed()` as shown in the following code segment:

```
struct timeval timeout;
timeout.tv_sec = 30; /* 30 seconds */
timeout.tv_usec = 0;

client = clnt_tp_create_timed(argv[1],
    TIME_PROG, TIME_VERS, nconf,
    &timeout);
```

Server

Code Example 4-11 shows the corresponding server. The command line that starts the service must specify the transport over which the service is provided.

CODE EXAMPLE 4-11 Server for Time Service, Intermediate Level

```
/*
 * This program supplies Greenwich mean
 * time to the client that invokes it.
 * The call format is: server netid
 */
#include <stdio.h>
#include <rpc/rpc.h>
#include <netconfig.h> /* For netconfig structure */
#include "time_prot.h"

static void time_prog();

main(argc, argv)
int argc;
char *argv[];
{
    SVCXPRT *transp;
    struct netconfig *nconf;

    if (argc != 2) {
        fprintf(stderr, "usage: %s netid\n",
            argv[0]);
        exit(1);
    }
    if ((nconf = getnetconfig(argv[1])) ==
        (struct netconfig *) NULL) {
        fprintf(stderr, "Could not find info on %s\n",
            argv[1]);
        exit(1);
    }
    transp = svc_tp_create(time_prog, TIME_PROG,
        TIME_VERS, nconf);
    if (transp == (SVCXPRT *) NULL) {
        fprintf(stderr, "%s: cannot create
            %s service\n", argv[0], argv[1]);
    }
}
```

(continued)

(Continuation)

```
    exit(1)
  }
  freenetconfigent(nconf);
  svc_run();
}

static
void time_prog(rqstp, transp)
  struct svc_req *rqstp;
  SVCXPRT *transp;
{
  /* Code identical to Top Level version */
}
```

Expert Level Interface

At the expert level, network selection is done the same as at the intermediate level. The only difference is in the increased level of control that the application has over the details of the CLIENT and SVCXPRT handles. These examples illustrate this control, which is exercised using the `clnt_tli_create()` and `svc_tli_create()` routines. For more information on TLI, see *Transport Interfaces Programming Guide*.

Client

Code Example 4-12 shows a version of `clntudp_create()` (the client creation routine for UDP transport) using `clnt_tli_create()`. The example shows how to do network selection based on the family of the transport you choose. `clnt_tli_create()` is used to create a client handle and to:

- Pass an open TLI file descriptor, which may or may not be bound
- Pass the server's address to the client
- Specify the send and receive buffer size

CODE EXAMPLE 4-12 Client for RPC Lower Level

```
#include <stdio.h>
#include <rpc/rpc.h>
#include <netconfig.h>
#include <netinet/in.h>
/*
 * In earlier implementations of RPC,
```

(continued)

(Continuation)

```
* only TCP/IP and UDP/IP were supported.
* This version of clntudp_create()
* is based on TLI/Streams.
*/
CLIENT *
clntudp_create(raddr, prog, vers, wait, sockp)
struct sockaddr_in *raddr; /* Remote address */
rpcprog_t prog;          /* Program number */
prcvers_t vers;         /* Version number */
struct timeval wait;     /* Time to wait */
int *sockp;              /* fd pointer */
{
    CLIENT *cl;          /* Client handle */
    int madefd = FALSE; /* Is fd opened here */
    int fd = *sockp;     /* TLI fd */
    struct t_bind *tbind; /* bind address */
    struct netconfig *nconf; /* netconfig structure */
    void *handlep;

    if ((handlep = setnetconfig() ) == (void *) NULL) {
        /* Error starting network configuration */
        rpc_createerr.cf_stat = RPC_UNKNOWNPROTO;
        return((CLIENT *) NULL);
    }
    /*
     * Try all the transports until it gets one that is
     * connectionless, family is INET, and preferred name is UDP
     */
    while (nconf = getnetconfig( handlep)) {
        if ((nconf->nc_semantics == NC_TPI_CLTS) &&
            (strcmp( nconf->nc_protofmly, NC_INET ) == 0) &&
            (strcmp( nconf->nc_proto, NC_UDP ) == 0))
            break;
    }
    if (nconf == (struct netconfig *) NULL)
        rpc_createerr.cf_stat = RPC_UNKNOWNPROTO;
        goto err;
    }
    if (fd == RPC_ANYFD) {
        fd = t_open(nconf->nc_device, O_RDWR, &tinfo);
        if (fd == -1) {
            rpc_createerr.cf_stat = RPC_SYSTEMERROR;
            goto err;
        }
    }
    if (raddr->sin_port == 0) { /* remote addr unknown */
        u_short sport;
        /*
         * rpcb_getport() is a user-provided routine that calls
         * rpcb_getaddr and translates the netbuf address to port
         * number in host byte order.
         */
        sport = rpcb_getport(raddr, prog, vers, nconf);
    }
}
```

(continued)

(Continuation)

```
if (sport == 0) {
    rpc_createerr.cf_stat = RPC_PROGUNAVAIL;
    goto err;
}
raddr->sin_port = htons(sport);
}
/* Transform sockaddr_in to netbuf */
tbind = (struct t_bind *) t_alloc(fd, T_BIND, T_ADDR);
if (tbind == (struct t_bind *) NULL)
    rpc_createerr.cf_stat = RPC_SYSTEMERROR;
    goto err;
}
if (t_bind->addr.maxlen < sizeof( struct sockaddr_in))
    goto err;
(void) memcpy( tbind->addr.buf, (char *)raddr,
              sizeof(struct sockaddr_in));
tbind->addr.len = sizeof(struct sockaddr_in);
/* Bind fd */
if (t_bind( fd, NULL, NULL) == -1) {
    rpc_createerr.ct_stat = RPC_TLIERROR;
    goto err;
}
cl = clnt_tli_create(fd, nconf, &(tbind->addr), prog, vers,
                   tinfo.tsdu, tinfo.tsdu);
/* Close the netconfig file */
(void) endnetconfig( handlep);
(void) t_free((char *) tbind, T_BIND);
if (cl) {
    *sockp = fd;
    if (madefd == TRUE) {
        /* fd should be closed while destroying the handle */
        (void)clnt_control(cl, CLSET_FD_CLOSE, (char *)NULL);
    }
    /* Set the retry time */
    (void) clnt_control( 1, CLSET_RETRY_TIMEOUT,
                       (char *) &wait);
    return(cl);
}
err:
if (madefd == TRUE)
    (void) t_close(fd);
(void) endnetconfig(handlep);
return((CLIENT *) NULL);
}
```

The network is selected using `setnetconfig()`, `getnetconfig()`, and `endnetconfig()`.

Note - `endnetconfig()` is not called until after the call to `clnt_tli_create()`, near the end of the example.

`clntudp_create()` can be passed an open TLI *fd*. If passed none (`fd == RPC_ANYFD`), it opens its own using the `netconfig` structure for UDP to find the name of the device to pass to `t_open()`.

If the remote address is not known (`raddr->sin_port == 0`), it is obtained from the remote `rpcbind`.

After the client handle has been created, you can modify it using calls to `clnt_control()`. The RPC library closes the file descriptor when destroying the handle (as it does with a call to `clnt_destroy()` when it opens the *fd* itself) and sets the retry time-out period.

Server

Code Example 4-13 shows the server side of Code Example 4-12. It is called `svcudp_create()`. The server side uses `svc_tli_create()`.

`svc_tli_create()` is used when the application needs a fine degree of control, particularly to:

- Pass an open file descriptor to the application.
- Pass the user's bind address.
- Set the send and receive buffer sizes. The *fd* argument may be unbound when passed in. If it is, then it is bound to a given address, and the address is stored in a handle. If the bind address is set to `NULL` and the *fd* is initially unbound, it will be bound to any suitable address.

Use `rpcb_set()` to register the service with `rpcbind`.

CODE EXAMPLE 4-13 Server for RPC Lower Level

```
#include <stdio.h>
#include <rpc/rpc.h>
#include <netconfig.h>
#include <netinet/in.h>

SVCXPRT *
svcudp_create(fd)
register int fd;
{
    struct netconfig *nconf;
    SVCXPRT *svc;
    int madefd = FALSE;
    int port;
```

(continued)

(Continuation)

```
void *handlep;
struct t_info tinfo;

/* If no transports available */
if ((handlep = setnetconfig() ) == (void *) NULL) {
    nc_perror("server");
    return((SVCXPRT *) NULL);
}
/*
 * Try all the transports until it gets one which is
 * connectionless, family is INET and, name is UDP
 */
while (nconf = getnetconfig( handlep)) {
    if ((nconf->nc_semantics == NC_TPI_CLTS) &&
        (strcmp( nconf->nc_protofmly, NC_INET) == 0 )&&
        (strcmp( nconf->nc_proto, NC_UDP) == 0 ))
        break;
}
if (nconf == (struct netconfig *) NULL) {
    endnetconfig(handlep);
    return((SVCXPRT *) NULL);
}
if (fd == RPC_ANYFD) {
    fd = t_open(nconf->nc_device, O_RDWR, &tinfo);
    if (fd == -1) {
        (void) endnetconfig();
        return((SVCXPRT *) NULL);
    }
    madefd = TRUE;
} else
    t_getinfo(fd, &tinfo);
svc = svc_tli_create(fd, nconf, (struct t_bind *) NULL,
                    tinfo.tsdu, tinfo.tsdu);
(void) endnetconfig(handlep);
if (svc == (SVCXPRT *) NULL) {
    if (madefd)
        (void) t_close(fd);
    return((SVCXPRT *)NULL);
}
return (svc);
}
```

The network selection here is accomplished similar to `clntudp_create()`. The file descriptor is not bound explicitly to a transport address because `svc_tli_create()` does that.

`svcdup_create()` can use an open *fd*. It will open one itself using the selected `netconfig` structure, if none is provided.

Bottom Level Interface

The bottom-level interface to RPC lets the application control all options. `clnt_tli_create()` and the other expert-level RPC interface routines are based on these routines. You rarely use these low-level routines.

Bottom-level routines create internal data structures, buffer management, RPC headers, and so on. Callers of these routines, like the expert level routine `clnt_tli_create()`, must initialize the `cl_netid` and `cl_tp` fields in the client handle. For a created handle, `cl_netid` is the network identifier (for example `udp`) of the transport and `cl_tp` is the device name of that transport (for example `/dev/udp`). The routines `clnt_dg_create()` and `clnt_vc_create()` set the `clnt_ops` and `cl_private` fields.

Client

Code Example 4-14 shows calls to `clnt_vc_create()` and `clnt_dg_create()`.

CODE EXAMPLE 4-14 Client for Bottom Level

```
/*
 * variables are:
 * cl: CLIENT *
 * tinfo: struct t_info returned from either t_open or t_getinfo
 * svcaddr: struct netbuf *
 */
switch(tinfo.servtype) {
case T_COTS:
case T_COTS_ORD:
    cl = clnt_vc_create(fd, svcaddr,
        prog, vers, sendsz, recvsz);
    break;
case T_CLTS:
    cl = clnt_dg_create(fd, svcaddr,
        prog, vers, sendsz, recvsz);
    break;
default:
    goto err;
}
```

These routines require that the file descriptor is open and bound. `svcaddr` is the address of the server.

Server

Code Example 4-15 is an example of creating a bottom-level server.

CODE EXAMPLE 4-15 Server for Bottom Level

```
/*
 * variables are:
```

```

* xprt: SVCXPRT *
*/
switch(tinfo.servtype) {
case T_COTS_ORD:
case T_COTS:
    xprt = svc_vc_create(fd, sendsz, recvsz);

    break;
case T_CLTS:
    xprt = svc_dg_create(fd, sendsz, recvsz);

    break;
default:
    goto err;
}

```

Server Caching

`svc_dg_enablecache()` initiates service caching for datagram transports. Caching should be used only in cases where a server procedure is a “once only” kind of operation, because executing a cached server procedure multiple times will yield different results.

```

svc_dg_enablecache(xprt, cache_size)
    SVCXPRT *xprt;
    unsigned int cache_size;

```

This function allocates a duplicate request cache for the service endpoint *xprt*, large enough to hold *cache_size* entries. A duplicate request cache is needed if the service contains procedures with varying results. Once enabled, there is no way to disable caching.

Low-Level Data Structures

The following are for reference only. The implementation may change.

First is the client RPC handle, defined in `<rpc/clnt.h>`. Low-level implementations must provide and initialize one handle per connection, as shown in Code Example 4–16.

CODE EXAMPLE 4–16 RPC Client Handle Structure

```

typedef struct {
    AUTH *cl_auth;          /* authenticator */
    struct clnt_ops {
        enum clnt_stat (*cl_call)(); /* call remote procedure */
        void (*cl_abort)(); /* abort a call */
        void (*cl_geterr)(); /* get specific error code */
        bool_t (*cl_freeres)(); /* frees results */
        void (*cl_destroy)(); /* destroy this structure */
        bool_t (*cl_control)(); /* the ioctl() of rpc */
    } *cl_ops;
}

```

```

caddr_t  cl_private;    /* private stuff */
char    *cl_netid;     /* network token *l
char    *cl_tp;        /* device name */
} CLIENT;

```

The first field of the client-side handle is an authentication structure, defined in <rpc/auth.h>. By default, it is set to AUTH_NONE. A client program must initialize cl_auth appropriately, as shown in Code Example 4-17.

CODE EXAMPLE 4-17 Client Authentication Handle

```

typedef struct {
    struct opaque_auth ah_cred;
    struct opaque_auth ah_verf;
    union des_block ah_key;
    struct auth_ops {
        void (*ah_nextverf)();
        int (*ah_marshall)(); /* nextverf & serialize */
        int (*ah_validate)(); /* validate varifier */
        int (*ah_refresh)(); /* refresh credentials */
        void (*ah_destroy)(); /* destroy this structure */
    } *ah_ops;
    caddr_t ah_private;
} AUTH;

```

In the AUTH structure, ah_cred contains the caller’s credentials, and ah_verf contains the data to verify the credentials. See “Authentication” on page 111 for details.

Code Example 4-18 shows the server transport handle.

CODE EXAMPLE 4-18 Server Transport Handle

```

typedef struct {
    int xp_fd;
#define xp_sock xp_fd
    u_short xp_port; /* associated port number. Obsolete */
    struct xp_ops {
        bool_t (*xp_rcv)(); /* receive incoming requests */
        enum xprt_stat (*xp_stat)(); /* get transport status */
        bool_t (*xp_getargs)(); /* get arguments */
        bool_t (*xp_reply)(); /* send reply */
        bool_t (*xp_freeargs)(); /* free mem alloc for args */
        void (*xp_destroy)(); /* destroy this struct */
    } *xp_ops;
    int xp_addrlen; /* length of remote addr. Obsolete */
    char *xp_tp; /* transport provider device name */
    char *xp_netid; /* network token */
    struct netbuf xp_ltaddr; /* local transport address */
    struct netbuf xp_rtaddr; /* remote transport address */
    char xp_raddr[16]; /* remote address. Now obsolete */
    struct opaque_auth xp_verf; /* raw response verifier */
    caddr_t xp_p1; /* private: for use by svc ops */
    caddr_t xp_p2; /* private: for use by svc ops */
    caddr_t xp_p3; /* private: for use by svc lib */
} SVCXPRT;

```

Table 4-5 shows the fields for the server transport handle.

TABLE 4-5 RPC Server Transport Handle Fields

<code>xp_fd</code>	The file descriptor associated with the handle. Two or more server handles can share the same file descriptor.
<code>xp_netid</code>	The network identifier (e.g. <code>udp</code>) of the transport on which the handle is created and <code>xp_tp</code> is the device name associated with that transport.
<code>xp_ltaddr</code>	The server's own bind address.
<code>xp_rtaddr</code>	The address of the remote caller (and so may change from call to call).
<code>xp_netid xp_tp xp_ltaddr</code>	Initialized by <code>svc_tli_create()</code> and other expert-level routines.

The rest of the fields are initialized by the bottom-level server routines `svc_dg_create()` and `svc_vc_create()`.

For connection-oriented endpoints, the fields in Table 4-6 are not valid until a connection has been requested and accepted for the server:

TABLE 4-6 RPC Connection-Oriented Endpoints

Fields Not Valid Until Connection Is Accepted		
<code>xp_fd</code>	<code>xp_ops()</code>	<code>xp_p1()</code>
<code>xp_p2</code>	<code>xp_verf()</code>	<code>xp_tp()</code>
<code>xp_ltaddr</code>	<code>xp_rtaddr()</code>	<code>xp_netid()</code>

Testing Programs Using Low-level Raw RPC

There are two pseudo-RPC interface routines that bypass all the network software. The routines shown in , `clnt_raw_create()` and `svc_raw_create()`, do not use any real transport.

Note - Do not use raw mode on production systems. Raw mode is intended as a debugging aid only. Raw mode is not MT safe.

is compiled and linked using the following Makefile:

```
all: raw
CFLAGS += -g
raw: raw.o
cc -g -o raw raw.o -lnsl
```

CODE EXAMPLE 4-19 Simple Program Using Raw RPC

```
/*
 * A simple program to increment a number by 1
 */

#include <stdio.h>
#include <rpc/rpc.h>
#include <rpc/raw.h>
#define prognum 0x40000001
#define versnum 1
#define INCR 1

struct timeval TIMEOUT = {0, 0};
static void server();

main (argc, argv)
int argc;
char **argv;
{
    CLIENT *cl;
    SVCXPRT *svc;
    int num = 0, ans;
    int flag;

    if (argc == 2)
        num = atoi(argv[1]);
    svc = svc_raw_create();
    if (svc == (SVCXPRT *) NULL) {
        fprintf(stderr, "Could not create server handle\n");
```

(continued)

(Continuation)

```
    exit(1);
}
flag = svc_reg( svc, prognum, versnum, server,
               (struct netconfig *) NULL );
if (flag == 0) {
    fprintf(stderr, "Error: svc_reg failed.\n");
    exit(1);
}
cl = clnt_raw_create( prognum, versnum );
if (cl == (CLIENT *) NULL) {
    clnt_pcreateerror("Error: clnt_raw_create");
    exit(1);
}
if (clnt_call(cl, INCR, xdr_int, (caddr_t) &num, xdr_int,
             (caddr_t) &ans, TIMEOUT)
    != RPC_SUCCESS) {
    clnt_perror(cl, "Error: client_call with raw");
    exit(1);
}
printf("Client: number returned %d\n", ans);
exit(0);
}

static void
server(rqstp, transp)
    struct svc_req *rqstp;
    SVCXPRT *transp;
{
    int num;

    fprintf(stderr, "Entering server procedure.\n");

    switch(rqstp->rq_proc) {
    case NULLPROC:
        if (svc_sendreply( transp, xdr_void,
                          (caddr_t) NULL) == FALSE) {
            fprintf(stderr, "error in null proc\n");
            exit(1);
        }
        return;
    case INCR:
        break;
    default:
        svcerr_noproc(transp);
        return;
    }
    if (!svc_getargs( transp, xdr_int, &num)) {
        svcerr_decode(transp);
        return;
    }
    fprintf(stderr, "Server procedure: about to increment.\n");
    num++;
}
```

(continued)

(Continuation)

```
if (svc_sendreply(transp, xdr_int, &num) == FALSE) {
    fprintf(stderr, "error in sending answer\n");
    exit (1);
}
fprintf(stderr, "Leaving server procedure.\n");
}
```

Note the following points in :

- The server must be created before the client.
- `svc_raw_create()` has no parameters.
- The server is not registered with `rpcbind`. The last parameter to `svc_reg()` is `(struct netconfig *) NULL`, which means that it will not be registered with `rpcbind`.
- `svc_run()` is not called.
- All the RPC calls occur within the same thread of control.
- The server-dispatch routine is the same as for normal RPC servers.

Advanced RPC Programming Techniques

This section addresses areas of occasional interest to developers using the lower level interfaces of the RPC package. The topics are:

- `poll()` on the server— how a server can call the dispatcher directly if calling `svc_run()` is not feasible
- Broadcast RPC — how to use the broadcast mechanisms
- Batching —how to improve performance by batching a series of calls
- Authentication — what methods are available in this release
- Port monitors — how to interface with the `inetd` and `listener` port monitors
- Multiple program versions — how to service multiple program versions

poll() on the Server Side

This section applies only to servers running RPC in single-threaded (default) mode.

A process that services RPC requests and performs some other activity cannot always call `svc_run()`. If the other activity periodically updates a data structure, the process can set a `SIGALRM` signal before calling `svc_run()`. This allows the signal handler to process the data structure and return control to `svc_run()` when done.

A process can bypass `svc_run()` and access the dispatcher directly with the `svc_getreqset()` call. Given the file descriptors of the transport endpoints associated with the programs being waited on, the process can have its own `poll()` that waits on both the RPC file descriptors and its own descriptors.

Code Example 4-20 shows `svc_run()`. `svc_pollset` is an array of `pollfd` structures that is derived, through a call to `__rpc_select_to_poll()`, from `svc_fdset()`. The array can change every time any RPC library routine is called, because descriptors are constantly being opened and closed. `svc_getreq_poll()` is called when `poll()` determines that an RPC request has arrived on some RPC file descriptors.

Note - The functions `__rpc_dtbsize()` and `__rpc_select_to_poll()` are not part of the SVID, but they are available in the `libnsl` library. The descriptions of these functions are included here so that you may create versions of these functions for non-Solaris implementations.

```
int __rpc_select_to_poll(int fdmax, fd_set *fdset,
                       struct pollfd *pollset)
```

Given an `fd_set` pointer and the number of bits to check in it, this function initializes the supplied `pollfd` array for RPC's use. RPC polls only for input events. The number of `pollfd` slots that were initialized is returned.

```
int __rpc_dtbsize()
```

This function calls the `getrlimit()` function to determine the maximum value that the system may assign to a newly created file descriptor. The result is cached for efficiency.

For more information on the SVID routines in this section, see the `rpc_svc_calls(3NSL)` and the `poll(2)` man pages.

CODE EXAMPLE 4-20 `svc_run()` and `poll()`

```
void
svc_run()
{
    int nfds;
    int dtbsize = __rpc_dtbsize();
    int i;
```

```

struct pollfd svc_pollset[fd_setsize];

for (;;) {
    /*
     * Check whether there is any server fd on which we may have
     * to wait.
     */
    nfd = __rpc_select_to_poll(dtbsize, &svc_fdset,
                              svc_pollset);

    if (nfd == 0)
        break; /* None waiting, hence quit */

    switch (i = poll(svc_pollset, nfd, -1)) {
    case -1:
        /*
         * We ignore all errors, continuing with the assumption
         * that it was set by the signal handlers (or any
         * other outside event) and not caused by poll().
         */
    case 0:
        continue;
    default:
        svc_getreq_poll(svc_pollset, i);
    }
}

```

Broadcast RPC

When an RPC broadcast is issued, a message is sent to all `rpcbind` daemons on a network. An `rpcbind` daemon with which the requested service is registered forwards the request to the server. The main differences between broadcast RPC and normal RPC calls are:

- Normal RPC expects one answer; broadcast RPC expects many answers (one or more answer from each responding machine).
- Broadcast RPC works only on connectionless protocols that support broadcasting, such as UDP.
- With broadcast RPC, all unsuccessful responses are filtered out; so, if there is a version mismatch between the broadcaster and a remote service, the broadcaster never hears from the service.
- Only datagram services registered with `rpcbind` are accessible through broadcast RPC; service addresses may vary from one host to another, so `rpc_broadcast()` sends messages to `rpcbind`'s network address.
- The size of broadcast requests is limited by the maximum transfer unit (MTU) of the local network; the MTU for Ethernet is 1500 bytes.

Code Example 4-21 shows how `rpc_broadcast()` is used and describes its arguments.

CODE EXAMPLE 4-21 RPC Broadcast

```
/*
 * bcast.c: example of RPC broadcasting use.
 */

#include <stdio.h>
#include <rpc/rpc.h>

main(argc, argv)
int argc;
char *argv[];
{
    enum clnt_stat rpc_stat;
    rpcprog_t prognum;
    rpcvers_t vers;
    struct rpcent *re;

    if(argc != 3) {
        fprintf(stderr, "usage : %s RPC_PROG VERSION\n", argv[0]);
        exit(1);
    }
    if (isdigit( *argv[1]))
        prognum = atoi(argv[1]);
    else {
        re = getrpcbyname(argv[1]);
        if (! re) {
            fprintf(stderr, "Unknown RPC service %s\n", argv[1]);
            exit(1);
        }
        prognum = re->r_number;
    }
    vers = atoi(argv[2]);
    rpc_stat = rpc_broadcast(prognum, vers, NULLPROC, xdr_void,
        (char *)NULL, xdr_void, (char *)NULL, bcast_proc,
    NULL);
    if ((rpc_stat != RPC_SUCCESS) && (rpc_stat != RPC_TIMEDOUT)) {
        fprintf(stderr, "broadcast failed: %s\n",
            clnt_sperrno(rpc_stat));
        exit(1);
    }
    exit(0);
}
```

The function in Code Example 4-22 collects replies to the broadcast. Normal operation is to collect either the first reply or all replies. `bcast_proc()` displays the IP address of the server that has responded. Since the function returns `FALSE` it will continue to collect responses, and the RPC client code will continue to resend the broadcast until it times out.

CODE EXAMPLE 4-22 Collect Broadcast Replies

```
bool_t
bcast_proc(res, t_addr, nconf)
void *res;          /* Nothing comes back */
struct t_bind *t_addr; /* Who sent us the reply */
struct netconfig *nconf;
{
    register struct hostent *hp;
    char *naddr;

    naddr = taddr2naddr(nconf, &t_addr->addr);
    if (naddr == (char *) NULL) {
        fprintf(stderr, "Responded: unknown\n");
    } else {
        fprintf(stderr, "Responded: %s\n", naddr);
        free(naddr);
    }
    return(FALSE);
}
```

If done is TRUE, then broadcasting stops, and `rpc_broadcast()` returns successfully. Otherwise, the routine waits for another response. The request is rebroadcast after a few seconds of waiting. If no responses come back, the routine returns with `RPC_TIMEDOUT`.

Batching

RPC is designed so that clients send a call message and wait for servers to reply to the call. This implies that a client is blocked while the server processes the call. This is inefficient when the client does not need each message acknowledged.

RPC batching lets clients process asynchronously. RPC messages can be placed in a pipeline of calls to a server. Batching requires that:

- The server does not respond to any intermediate message.
- The pipeline of calls is transported on a reliable transport, such as TCP.
- The result's XDR routine in the calls must be NULL.
- The RPC call's time-out must be zero.

Because the server does not respond to each call, the client can send new calls in parallel with the server processing previous calls. The transport can buffer many call messages and send them to the server in one `write()` system call. This decreases interprocess communication overhead and the total time of a series of calls. The client should end with a nonbatched call to flush the pipeline.

Code Example 4-23 shows the unbatched version of the client. It scans the character array, *buf*, for delimited strings and sends each string to the server.

CODE EXAMPLE 4-23 Unbatched Client

```
#include <stdio.h>
#include <rpc/rpc.h>
#include "windows.h"

main(argc, argv)
int argc;
char **argv;
{
    struct timeval total_timeout;
    register CLIENT *client;
    enum clnt_stat clnt_stat;
    char buf[1000], *s = buf;

    if ((client = clnt_create( argv[1], WINDOWPROG, WINDOWVERS,
        "circuit_v")) == (CLIENT *) NULL) {
        clnt_pcreateerror("clnt_create");
        exit(1);
    }

    total_timeout.tv_sec = 20;
    total_timeout.tv_usec = 0;
    while (scanf( "%s", s ) != EOF) {
        if (clnt_call(client, RENDERSTRING, xdr_wrapstring, &s,
            xdr_void, (caddr_t) NULL, total_timeout) != RPC_SUCCESS) {
            clnt_perror(client, "rpc");
            exit(1);
        }
    }

    clnt_destroy( client );
    exit(0);
}
```

Code Example 4-24 shows the batched version of the client. It does not wait after each string is sent to the server. It waits only for an ending response from the server.

CODE EXAMPLE 4-24 Batched Client

```
#include <stdio.h>
#include <rpc/rpc.h>
#include "windows.h"

main(argc, argv)
int argc;
char **argv;
{
    struct timeval total_timeout;
    register CLIENT *client;
```

(continued)

(Continuation)

```
enum clnt_stat clnt_stat;
char buf[1000], *s = buf;

if ((client = clnt_create( argv[1], WINDOWPROG, WINDOWVERS,
    "circuit_v")) == (CLIENT *) NULL) {
    clnt_pcreateerror("clnt_create");
    exit(1);
}
timerclear(&total_timeout);
while (scanf("%s", s) != EOF)
    clnt_call(client, RENDERSTRING_BATCHED, xdr_wrapstring,
        &s, xdr_void, (caddr_t) NULL, total_timeout);
/* Now flush the pipeline */
total_timeout.tv_sec = 20;
clnt_stat = clnt_call(client, NULLPROC, xdr_void,
    (caddr_t) NULL, xdr_void, (caddr_t) NULL,
total_timeout);
if (clnt_stat != RPC_SUCCESS) {
    clnt_perror(client, "rpc");
    exit(1);
}
clnt_destroy(client);
exit(0);
}
```

Code Example 4-25 shows the dispatch portion of the batched server. Because the server sends no message, the clients are not notified of failures.

CODE EXAMPLE 4-25 Batched Server

```
#include <stdio.h>
#include <rpc/rpc.h>
#include "windows.h"

void
windowdispatch(rqstp, transp)
    struct svc_req *rqstp;
    SVCXPRT *transp;
{
    char *s = NULL;

    switch(rqstp->rq_proc) {
    case NULLPROC:
        if (!svc_sendreply( transp, xdr_void, NULL))
            fprintf(stderr, "can't reply to RPC call\n");
        return;
    case RENDERSTRING:
```

(continued)

(Continuation)

```
if (!svc_getargs( transp, xdr_wrapstring, &s)) {
    fprintf(stderr, "can't decode arguments\n");
    /* Tell caller an error occurred */
    svcerr_decode(transp);
    break;
}
/* Code here to render the string s */
if (!svc_sendreply( transp, xdr_void, (caddr_t) NULL))
    fprintf( stderr, "can't reply to RPC call\n");
break;
case RENDERSTRING_BATCHED:
    if (!svc_getargs(transp, xdr_wrapstring, &s)) {
        fprintf(stderr, "can't decode arguments\n");
        /* Be silent in the face of protocol errors */
        break;
    }
    /* Code here to render string s, but send no reply! */
    break;
default:
    svcerr_noproc(transp);
    return;
}
/* Now free string allocated while decoding arguments */
svc_freeargs(transp, xdr_wrapstring, &s);
}
```

Batching Performance

To illustrate the benefits of batching, the examples in Code Example 4-23 and Code Example 4-25 were completed to render the lines in a 25144-line file. The rendering service simply throws the lines away. The batched version of the application was four times as fast as the unbatched version.

Authentication

In all of the preceding examples in this chapter, the caller has not identified itself to the server, and the server has not required identification of the caller. Some network services, such as a network file system, require caller identification. Refer to *System Administration Guide*, to implement any of the authentication methods described in this section.

Just as different transports can be used when creating RPC clients and servers, different “flavors” of authentication can be associated with RPC clients. The authentication subsystem of RPC is open ended. So, many flavors of authentication can be supported. The authentication protocols are further defined in Appendix B.

Sun RPC currently supports the authentication flavors shown in Table 4-7.

TABLE 4-7 Authentication Methods Supported By Sun RPC

AUTH_NONE	Default. No authentication performed
AUTH_SYS	An authentication flavor based on UNIX operating system, process permissions authentication
AUTH_SHORT	An alternate flavor of AUTH_SYS used by some servers for efficiency. Client programs using AUTH_SYS authentication can receive AUTH_SHORT response verifiers from some servers. See Appendix B for details
AUTH_DES	An authentication flavor based on DES encryption techniques
AUTH_KERB	Version 5 Kerberos authentication based on DES framework

When a caller creates a new RPC client handle as in:

```
clnt = clnt_create(host, prognum, versnum, nettype);
```

the appropriate client-creation routine sets the associated authentication handle to:

```
clnt->cl_auth = authnone_create();
```

If you create a new instance of authentication, you must destroy it with `auth_destroy(clnt->cl_auth)`. This should be done to conserve memory.

On the server side, the RPC package passes the service-dispatch routine a request that has an arbitrary authentication style associated with it. The request handle passed to a service-dispatch routine contains the structure `rq_cred`. It is opaque, except for one field: the flavor of the authentication credentials.

```
/*
 * Authentication data
 */
struct opaque_auth {
    enum_t    oa_flavor; /* style of credentials */
    caddr_t   oa_base;   /* address of more auth stuff */
    u_int     oa_length; /* not to exceed MAX_AUTH_BYTES */
};
```

The RPC package guarantees the following to the service-dispatch routine:

- The `rq_cred` field in the `svc_req` structure is well formed. So, you can check `rq_cred.oa_flavor` to get the flavor of authentication. You can also check the other fields of `rq_cred` if the flavor is not supported by RPC.

- The `rq_clntcred` field that is passed to service procedures is either `NULL` or points to a well-formed structure that corresponds to a supported flavor of authentication credential. There is no authentication data for the `AUTH_NONE` flavor. `rq_clntcred` can be cast only as a pointer to an `authsys_parms`, `short_hand_verf`, `authkerb_cred`, or `authdes_cred` structure.

AUTH_SYS Authentication

The client can use `AUTH_SYS` (called `AUTH_UNIX` in previous releases) style authentication by setting `clnt->cl_auth` after creating the RPC client handle:

```
clnt->cl_auth = authsys_create_default();
```

This causes each RPC call associated with `clnt` to carry with it the following credentials-authentication structure shown in Code Example 4-26.

CODE EXAMPLE 4-26 AUTH_SYS Credential Structure

```
/*
 * AUTH_SYS flavor credentials.
 */
struct authsys_parms {
    u_long aup_time; /* credentials creation time */
    char *aup_machname; /* client's host name */
    uid_t aup_uid; /* client's effective uid */
    gid_t aup_gid; /* client's current group id */
    u_int aup_len; /* element length of aup_gids*/
    gid_t *aup_gids; /* array of groups user is in */
};
```

`rpc.broadcast` defaults to `AUTH_SYS` authentication.

Code Example 4-27 shows a server, with procedure `RUSERPROC_1()`, that returns the number of users on the network. As an example of authentication, it checks `AUTH_SYS` credentials and does not service requests from callers whose `uid` is 16.

CODE EXAMPLE 4-27 Authentication Server

```
nuser(rqstp, transp)
    struct svc_req *rqstp;
    SVCXPRT *transp;
{
    struct authsys_parms *sys_cred;
    uid_t uid;
    unsigned int nusers;

    /* NULLPROC should never be authenticated */
    if (rqstp->rq_proc == NULLPROC) {
        if (!svc_sendreply( transp, xdr_void, (caddr_t) NULL))
            fprintf(stderr, "can't reply to RPC call\n");
        return;
    }

    /* now get the uid */
```

```

switch(rqstp->rq_cred.oa_flavor) {
case AUTH_SYS:
    sys_cred = (struct authsys_parms *) rqstp->rq_clntcred;
    uid = sys_cred->aup_uid;
    break;
default:
    svcerr_weakauth(transp);
    return;
}
switch(rqstp->rq_proc) {
case RUSERSPROC_1:
    /* make sure caller is allowed to call this proc */
    if (uid == 16) {
        svcerr_systemerr(transp);

        return;
    }
    /*
     * Code here to compute the number of users and assign it
     * to the variable nusers
     */
    if (!svc_sendreply( transp, xdr_u_int, &nusers))
        fprintf(stderr, "can't reply to RPC call\n");
    return;
default:
    svcerr_noproc(transp);
    return;
}
}

```

Note the following:

- The authentication parameters associated with the `NULLPROC` (procedure number zero) are usually not checked.
- The server calls `svcerr_weakauth()` if the authentication parameter's flavor is too weak; there is no way to get the list of authentication flavors the server requires.
- The service protocol should return status for access denied; in Code Example 4-27, the protocol calls the service primitive `svcerr_systemerr()`, instead.

The last point underscores the relation between the RPC authentication package and the services: RPC deals only with authentication and not with an individual service's access control. The services themselves must establish access-control policies and reflect these policies as return statuses in their protocols.

AUTH_DES Authentication

Use `AUTH_DES` authentication for programs that require more security than `AUTH_SYS` provides. `AUTH_SYS` authentication is easy to defeat. For example, instead of using `authsys_create_default()`, a program can call `authsys_create()` and change the RPC authentication handle to give itself any desired user ID and hostname.

AUTH_DES authentication requires that `keyserv()` daemons are running on both the server and client hosts. The NIS or NIS+ naming service must also be running. Users on these hosts need public/secret key pairs assigned by the network administrator in the `publickey()` database. They must also have decrypted their secret keys with the `keylogin()` command (normally done by `login()` unless the login password and secure-RPC password differ).

To use AUTH_DES authentication, a client must set its authentication handle appropriately. For example:

```
cl->cl_auth = authdes_seccreate(servername, 60, server,
                               (char *)NULL);
```

The first argument is the network name or “netname” of the owner of the server process. Server processes are usually root processes, and you can get their netnames with the following call:

```
char servername[MAXNETNAMELEN];
host2netname(servername, server, (char *)NULL);
```

`servername` points to the receiving string and `server` is the name of the host the server process is running on. If the server process was run by a non-root user, use the call `user2netname()` as follows:

```
char servername[MAXNETNAMELEN];
user2netname(servername, serveruid(), (char *)NULL);
```

`serveruid()` is the user id of the server process. The last argument of both functions is the name of the domain that contains the server. NULL means “use the local domain name.”

The second argument of `authdes_seccreate()` is the lifetime (known also as the window) of the client’s credential, here, 60 seconds. A credential will expire 60 seconds after the client makes an RPC call. If a program tries to reuse the credential, the server RPC subsystem recognizes that it has expired and does not service the request carrying the expired credential. If any program tries to reuse a credential within its lifetime, it is rejected, because the server RPC subsystem saves credentials it has seen in the near past and does not serve duplicates.

The third argument of `authdes_seccreate()` is the name of the *timehost* used to synchronize clocks. AUTH_DES authentication requires that server and client agree on the time. The example specifies to synchronize with the server. A `(char *)NULL` says not to synchronize. Do this only when you are sure that the client and server are already synchronized.

The fourth argument of `authdes_seccreate()` points to a DES encryption key to encrypt time stamps and data. If this argument is `(char *)NULL`, as it is in this example, a random key is chosen. The `ah_key` field of the authentication handle contains the key.

The server side is simpler than the client. Code Example 4-28 shows the server in Code Example 4-27 changed to use AUTH_DES.

CODE EXAMPLE 4-28 AUTH_DES Server

```
#include <rpc/rpc.h>
...
...
nuser(rqstp, transp)
  struct svc_req *rqstp;
  SVCXPRT *transp;
  {
    struct authdes_cred *des_cred;
    uid_t uid;
    gid_t gid;
    int gidlen;
    gid_t gidlist[10];

    /* NULLPROC should never be authenticated */
    if (rqstp->rq_proc == NULLPROC) {
      /* same as before */
    }
    /* now get the uid */
    switch(rqstp->rq_cred.oa_flavor) {
      case AUTH_DES:
        des_cred = (struct authdes_cred *) rqstp->rq_clntcred;
        if (! netname2user( des_cred->adc_fullname.name, &uid,
                          &gid, &gidlen, gidlist)) {
          fprintf(stderr, "unknown user: %s\n",
                des_cred->adc_fullname.name);
          svcerr_systemerr(transp);
          return;
        }
        break;
      default:
        svcerr_weakauth(transp);
        return;
    }
    /* The rest is the same as before */
  }
```

Note the routine `netname2user()` converts a network name (or “netname” of a user) to a local system ID. It also supplies group IDs (not used in this example).

AUTH_KERB Authentication

SunOS 5.x includes support for most client-side features of Kerberos 5, except `klogin`. AUTH_KERB is conceptually similar to AUTH_DES; the essential difference is that DES passes a network name and DES-encrypted session key, while Kerberos passes the encrypted service ticket. The other factors that affect implementation and interoperability are given in the following subsections.

For more information, see the `kerberos(3KRB)` man page and the Steiner-Neuman-Shiller paper¹ on the MIT Project Athena implementation of Kerberos. You may access MIT documentation through the FTP directory `/pub/kerberos/doc` on `athena-dist.mit.edu`, or through Mosaic, using the document URL, `ftp://athena-dist.mit.edu/pub/kerberos/doc`.

Time Synchronization

Kerberos uses the concept of a time window in which its credentials are valid. It does not place restrictions on the clocks of the client or server. The client is required to determine the time bias between itself and the server and compensate for the difference by adjusting the window time specified to the server. Specifically, the *window* is passed as an argument to `authkerb_seccreate()`; the window does not change. If a *timehost* is specified as an argument, the client side gets the time from the *timehost* and alters its timestamp by the difference in time. Various methods of time synchronization are available. See the `kerberos_rpc(3KRB)` man page for more information.

Well-Known Names

Kerberos users are identified by a primary name, instance, and realm. The RPC authentication code ignores the realm and instance, while the Kerberos library code does not. The assumption is that user names are the same between client and server. This enables a server to translate a primary name into user identification information. Two forms of well-known names are used (omitting the realm):

- `root.host` represents a privileged user on client *host*.
- `user.ignored` represents the user whose user name is *user*. The instance is ignored.

Encryption

Kerberos uses cipher block chaining (CBC) mode when sending a full name credential (one that includes the ticket and window), and electronic code book (ECB) mode otherwise. CBC and ECB are two methods of DES encryption. See the `des_crypt(3)` man page for more information. The session key is used as the initial input vector for CBC mode. The notation

```
xdr_type(object)
```

means that XDR is used on *object* as a `type`. The length in the next code section is the size, in bytes of the credential or verifier, rounded up to 4-byte units. The full name credential and verifier are obtained as follows:

1. Steiner, Jennifer G., Neuman, Clifford, and Schiller, Jeffrey J. "Kerberos: An Authentication Service for Open Network Systems." *USENIX Conference Proceedings*, USENIX Association, Berkeley, CA, June 1988.

```
xdr_long(timestamp.seconds)
xdr_long(timestamp.useconds)
xdr_long(window)
xdr_long(window - 1)
```

After encryption with CBC with input vector equal to the session key, the output is two DES cipher blocks:

```
CB0
CB1.low
CB1.high
```

The credential is:

```
xdr_long(AUTH_KERB)
xdr_long(length)
xdr_enum(AKN_FULLNAME)
xdr_bytes(ticket)
xdr_opaque(CB1.high)
```

The verifier is:

```
xdr_long(AUTH_KERB)
xdr_long(length)
xdr_opaque(CB0)
xdr_opaque(CB1.low)
```

The nickname exchange yields:

```
xdr_long(timestamp.seconds)
xdr_long(timestamp.useconds)
```

The nickname is encrypted with ECB to obtain ECB0, and the credential is:

```
xdr_long(AUTH_KERB)
xdr_long(length)
xdr_enum(AKN_NICKNAME)
xdr_opaque(akc_nickname)
```

The verifier is:

```
xdr_long(AUTH_KERB)
xdr_long(length)
xdr_opaque(ECB0)
xdr_opaque(0)
```

Authentication Using RPCSEC_GSS

The authentication flavors mentioned previously – AUTH_SYS, AUTH_DES, and AUTH_KERB – can be overcome by a determined snoop. For this reason a new networking layer, the Generic Security Standard API, or GSS-API, has been added. The GSS-API framework offers two extra services beyond authentication:

- *Integrity.* With the integrity service, the GSS-API uses the underlying mechanism to authenticate messages exchanged between programs. Cryptographic checksums establish:
 - The identity of the data originator to the recipient
 - The identity of the recipient to the originator (if mutual authentication is requested)
 - The authenticity of the transmitted data itself
- *Privacy.* The privacy service includes the integrity service. In addition, the transmitted data is also *encrypted* so as to protect it from any eavesdroppers.

Due to U.S. export restrictions, the privacy service might not be available to all users.

Note - Currently, the GSS-API is not exposed. Certain GSS-API features, however, are “visible” through RPCSEC_GSS functions — they can be manipulated in an “opaque” fashion. The programmer need not be directly concerned with their values.

The RPCSEC_GSS API

The RPCSEC_GSS security flavor allows ONC RPC applications to take advantage of the features of GSS-API. RPCSEC_GSS sits “on top” of the GSS-API layer as follows:

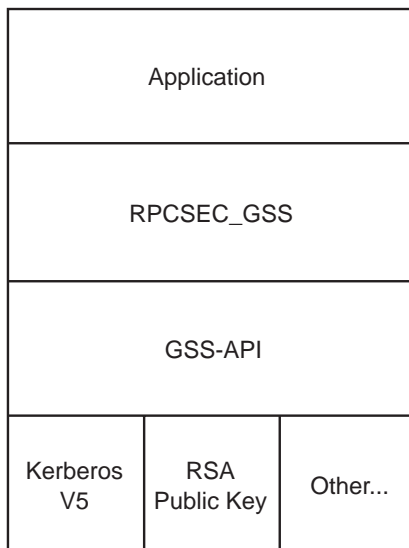

Figure 4-1 GSS-API and RPCSEC_GSS Security Layers

Using the programming interface for RPCSEC_GSS, ONC RPC applications can specify:

mechanism	A security paradigm. Each kind of security mechanism offers a different kind of data protection, as well as one or more levels of data protection. In this case, any security mechanism supported by the GSS-API (Kerberos V5, RSA public key, and so forth).
security service	Either privacy or integrity (or neither). The default is integrity. The service is mechanism-independent.
QOP	Quality of Protection. The QOP specifies the type of cryptographic algorithm to be used to implement privacy or integrity services. Each security mechanism can have one or more QOPs associated with it.

Applications can obtain lists of valid QOPs and mechanisms through functions provided by RPCSEC_GSS. (See “Miscellaneous Functions” on page 128.) Developers should avoid hard-coding mechanisms and QOPs into their applications, so that the applications will not need to be modified to use new or different mechanisms and QOPs.

Note - Historically, “security flavor” and “authentication flavor” have meant the same thing. With the introduction of RPCSEC_GSS, “flavor” now has a somewhat different sense. A flavor can now include a service (integrity or privacy) along with authentication, although currently RPCSEC_GSS is the only flavor that does.

Using RPCSEC_GSS, ONC RPC applications establish a security context with a peer, exchange data, and destroy the context, just as they do with other flavors. Once a context is established, the application can change the QOP and service for each data unit sent.

For more information on RPCSEC_GSS, including RPCSEC_GSS data types, see the `rpcsec_gss(3N)` man page.

RPCSEC_GSS Routines

Table 4–8 summarizes RPCSEC_GSS commands. It is intended as a general overview of RPCSEC_GSS functions, rather than a specific description of each one. For more information on each function, see its man page, or check the `rpcsec_gss(3N)` man page for an overview, including a list of RPCSEC_GSS data structures.

TABLE 4-8 RPCSEC_GSS Functions

Action	Function	Input	Output
Create a security context	<code>rpc_gss_seccreate()</code>	CLIENT handle, principal name, mechanism, QOP, service type	AUTH handle
Change QOP, service type for context	<code>rpc_gss_set_defaults()</code>	Old QOP, service	New QOP, service
Show maximum size for data before security transformation	<code>rpc_gss_max_data_length()</code>	Maximum data size allowed by transport	Maximum pre-transformation data size
Show maximum size for data before security transformation	<code>rpc_gss_svc_max_data_length()</code>	Maximum data size allowed by transport	Maximum pre-transformation data size
Set name of principal(s) for server to represent	<code>rpc_gss_set_svc_name()</code>	Principal name, RPC program, version #s	TRUE if successful
Fetch credentials of caller (client)	<code>rpc_gss_getcred()</code>	Pointer to <code>svc_req</code> structure	UNIX credentials, RPCSEC_GSS credentials, cookie
Specify (user-written) callback function	<code>rpc_gss_set_callback()</code>	Pointer to callback function	TRUE if successful
Create RPCSEC_GSS structure for principal names from unique parameters	<code>rpc_gss_get_principal_name()</code>	Mechanism, user name, machine name, domain name	RPCSEC_GSS principal name structure
Fetch an error code when an RPCSEC_GSS routine fails	<code>rpc_gss_get_error()</code>		RPCSEC_GSS error number, <code>errno</code> if applicable
Get strings for installed mechanisms	<code>rpc_gss_get_mechanisms()</code>		List of valid mechanisms
Get valid QOP strings	<code>rpc_gss_get_mech_info()</code>	Mechanism	Valid QOPs for that mechanism

TABLE 4-8 RPCSEC_GSS Functions (continued)

Action	Function	Input	Output
Get the highest, lowest version numbers of RPCSEC_GSS supported	<code>rpc_gss_get_versions()</code>		Highest, lowest versions
Check to see if a mechanism is installed	<code>rpc_gss_is_installed()</code>	Mechanism	TRUE if installed
Convert ASCII mechanism to RPC object identifier	<code>rpc_gss_mech_to_oid()</code>	Mechanism (as string)	Mechanism (as OID)
Convert ASCII QOP to integer	<code>rpc_gss_qop_to_num()</code>	QOP (as string)	QOP (as integer)

Creating a Context

Contexts are created with the `rpc_gss_seccreate()` call. This function takes as its arguments:

- A client handle (returned, for example, by `clnt_create()`)
- The name of the server principal (for example, `nfs@acme.com`)
- The mechanism (for example, Kerberos V5) for the session
- The security service type (for example, privacy)
- The QOP for the session
- Two GSS-API parameters that can remain opaque for most uses (that is, the programmer can supply NULL values)

It returns an AUTH authentication handle. Code Example 4-29 shows how `rpc_gss_seccreate()` might be used to create a context using the Kerberos V5 security mechanism and the integrity service:

CODE EXAMPLE 4-29 `rpc_gss_seccreate()`

```
CLIENT *clnt;                /* client handle */
char server_host[] = "foo";
char service_name[] = "nfs@eng.acme.com";
char mech[] = "kerberos_v5";

clnt = clnt_create(server_host, SERVER_PROG, SERV_VERS, "netpath");
```

```

clnt->clnt_auth = rpc_gss_seccreate(clnt, service_name, mech,
                                   rpc_gss_svc_integrity, NULL, NULL, NULL);
. . .

```

A few things to note about Code Example 4-29 are:

- Although the mechanism was declared explicitly (for ease of reading), it would be more commonly obtained programmatically with `rpc_gss_get_mechanisms()` from a table of available mechanisms.
- The QOP is passed as a `NULL`, which sets the QOP to this mechanism's default. Otherwise, a valid value could, as with the mechanism, be obtained programmatically with `rpc_gss_get_mechanisms()`. See the `rpc_gss_get_mechanisms(3N)` man page for more information.
- The security service type, `rpc_gss_svc_integrity`, is an enum of the `RPCSEC_GSS` type `rpc_gss_service_t`. `rpc_gss_service_t` has the following format:

```

typedef enum {
    rpc_gss_svc_default = 0,
    rpc_gss_svc_none = 1,
    rpc_gss_svc_integrity = 2,
    rpc_gss_svc_privacy = 3
} rpc_gss_service_t;

```

The default security service maps to integrity, so the programmer could have specified `rpc_gss_svc_default` and obtained the same result.

For more information, see the `rpc_gss_seccreate(3N)` man page.

Changing Values and Destroying a Context

Once a context has been set, the application may need to change QOP and service values for individual data units being transmitted. (For example, you might want a program to encrypt a password but not a login name.) `rpc_gss_set_defaults()` allows you to do so:

CODE EXAMPLE 4-30 `rpc_gss_set_defaults()`

```

rpc_gss_set_defaults(clnt->clnt_auth, rpc_gss_svc_privacy, qop);
. . .

```

In this case, the security service is set to privacy (see “Creating a Context” on page 122). `qop` is a pointer to a string naming the new QOP.

Contexts are destroyed in the usual way, with `auth_destroy()`.

For more information on changing service and QOP, see the `rpc_gss_set_defaults(3N)` man page.

Principal Names

Two types of principal names are needed to establish and maintain a security context:

- A *server* principal name. A server's principal name is always specified as a NULL-terminated ASCII string of the form *service@host* — for example, `nfs@eng.acme.com`.

When a client creates a security context, it specifies the server principal name in this format (see “Creating a Context” on page 122). Similarly, when a server needs to set the name of a principal it will represent, it uses

`rpc_gss_set_svc_name()`, which takes a principal name in this format as an argument.

- A *client* principal name. The principal name of a client, as received by a server, takes the form of an `rpc_gss_principal_t` structure: a counted, opaque byte string determined by the mechanism being used. This structure is described on the `rpcsec_gss(3N)` man page.

Setting Server Principal Names

A server needs to be told the names of the principals it will represent when it starts up. (A server may act as more than one principal.) `rpc_gss_set_svc_name()` sets the name of the principal(s):

CODE EXAMPLE 4-31 `rpc_gss_set_svc_name()`

```
char *principal, *mechanism;
u_int req_time;

principal = "nfs@eng.acme.com";
mechanism = "kerberos_v5";
req_time = 10000; /* time for which credential should be valid */

rpc_gss_set_svc_name(principal, mechanism, req_time, SERV_PROG, SERV_VERS);
```

(Kerberos ignores the *req_time* parameter. Other authentication systems may use it.)

For more information, see the `rpc_gss_set_svc_name(3N)` man page.

Generating Client Principal Names

Servers need to be able to operate on a client's principal name — for example, to compare a client's principal name to an access control list, or look up a UNIX

credential for that client, if such a credential exists. Such principal names are kept in the form of a `rpc_gss_principal_t` structure pointer. (See the `rpcsec_gss(3N)` man page for more on `rpc_gss_principal_t`.) If a server wants to compare a principal name it has received with the name of a known entity, it needs to be able to generate a principal name in that form.

The `rpc_gss_get_principal_name()` call takes as input several parameters that uniquely identify an individual on a network, and generates a principal name as a `rpc_gss_principal_t` structure pointer:

CODE EXAMPLE 4-32 `rpc_gss_get_principal_name()`

```
rpc_gss_principal_t *principal;

rpc_gss_get_principal_name(principal, mechanism, name, node, domain);
. . .
```

The arguments to `rpc_gss_get_principal_name()` are as follows:

- *principal* is a pointer to the `rpc_gss_principal_t` structure to be set.
- *mechanism* is the security mechanism being used (remember, the principal name being generated is mechanism-dependent).
- *name* is an individual or service name, such as `joeh` or `nfs`, or even the name of a user-defined application.
- *node* might be, for example, a UNIX machine name.
- *domain* might be, for example, a DNS, NIS, or NIS+ domain name, or a Kerberos realm.

Each security mechanism requires different identifying parameters. For example, Kerberos V5 requires a user name and, only optionally, qualified node and domain names (in Kerberos terms, host and realm names).

For more information, see the `rpc_gss_get_principal_name(3N)` man page.

Freeing Up Principal Names

Principal names are freed up using the `free()` library call.

Receiving Credentials at the Server

A server must be able to fetch the credentials of a client. The `rpc_gss_getcred()` function, shown in Code Example 4-33, allows the server to retrieve either UNIX credentials or RPCSEC_GSS credentials (or both, for that matter). It does so through two arguments that are set if the function is successful. One is a pointer to an `rpc_gss_ucred_t` structure, which contains the caller's UNIX credentials, if such exist:

```

typedef struct {
    uid_t  uid;          /* user ID */
    gid_t  gid;          /* group ID */
    short  gidlen;
    git_t  *gidlist;    /* list of groups */
} rpc_gss_ucred_t;

```

The other argument is a pointer to a `rpc_gss_raw_cred_t` structure, which looks like this:

```

typedef struct {
    u_int      version;          /* RPCSEC_GSS program version */
    char       *mechanism;
    char       *qop;
    rpc_gss_principal_t  client_principal; /* client principal name */
    char       *svc_principal;   /* server principal name */
    rpc_gss_service_t  service;   /* privacy, integrity enum */
} rpc_gss_rawcred_t;

```

(See “Generating Client Principal Names” on page 124 for a description of the `rpc_gss_principal_t` structure and how it is created.) Because `rpc_gss_rawcred_t` contains both the client and server principal names, `rpc_gss_getcred()` can return them both.

Code Example 4-33 is an example of a simple server-side dispatch procedure, in which the server gets the credentials for the caller. The procedure gets the caller’s UNIX credentials and then verifies the user’s identity, using the mechanism, QOP, and service type found in the `rpc_gss_rcred_t` argument.

CODE EXAMPLE 4-33 Getting Credentials

```

static void server_prog(struct svc_req *rqstp, SVCXPRT *xpirt)
{
    rpc_gss_ucred_t *ucred;
    rpc_gss_rawcred_t *rcred;

    if (rqstp->rq_proq == NULLPROC) {
        svc_sendreply(xpirt, xdr_void, NULL);
        return;
    }
    /*
     * authenticate all other requests */
    /*

    switch (rqstp->rq_cred.oa_flavor) {
    case RPCSEC_GSS:
        /*
         * get credential information
         */
        rpc_gss_getcred(rqstp, &rcred, &ucred, NULL);
        /*

```

(continued)

(Continuation)

```
* verify that the user is allowed to access
* using received security parameters by
* peeking into my config file
*/
if (!authenticate_user(ucred->uid, rcred->mechanism,
    rcred->qop, rcred->service)) {
    svcerr_weakauth(xprt);
    return;
}
break; /* allow the user in */
default:
    svcerr_weakauth(xprt);
    return;
} /* end switch */

switch (rqstp->rq_prog) {
case SERV_PROCL1:
    . . .
}

/* usual request processing; send response ... */

return;
}
```

For more information, see the `rpc_gss_getcred(3N)` man page.

Cookies

In Code Example 4-33, the last argument to `rpc_gss_getcred()` (here, a `NULL`) is a user-defined cookie, whose value on return will be whatever was specified by the server when the context was created. This cookie, a four-byte value, can be used in any way appropriate for the application — RPC does not interpret it. For example, the cookie can be a pointer or index to a structure that represents the context initiator; instead of computing this value for every request, the server computes it at context-creation time (thus saving on request-processing time).

Callbacks

Another place where cookies can be used is with callbacks. A server can specify a (user-defined) callback so that it knows when a context first gets used, by using the `rpc_gss_set_callback()` function. The callback is invoked the first time a

context is used for data exchanges, after the context is established for the specified program and version.

The user-defined callback routine takes the following form:

```
bool_t callback(struct svc_req *req, gss_cred_id_t deleg, gss_ctx_id_t gss_context,
rpc_gss_lock_t *lock, void **cookie);
```

The second and third arguments, *deleg* and *gss_context*, are GSS-API data types and are not currently exposed, so the callback function can ignore them. (Briefly, *deleg* is the identity of any delegated peer, while *gss_context* is a pointer to the GSS-API context, in case the program wanted to perform GSS-API operations on the context — that is, to test for acceptance criteria.) The *cookie* argument we have already seen.

The *lock* argument is a pointer to a `rpc_gss_lock_t` structure:

```
typedef struct {
    bool_t          locked;
    rpc_gss_rawcred_t *raw_cred;
} rpc_gss_lock_t;
```

This parameter enables a server to enforce a particular QOP and service for the session. QOP and service are found in the `rpc_gss_rawcred_t` structure described in Code Example 4-33. (A server should not change the values for service and QOP.) When the user-defined callback is invoked, the *locked* field is set to `FALSE`. If the server sets *locked* to `TRUE`, only requests with QOP and service values that match the QOP and service values in the `rpc_gss_rawcred_t` structure will be accepted.

For more information, see the `rpc_gss_set_callback(3N)` man page.

Maximum Data Size

Two functions — `rpc_gss_max_data_length()` and `rpc_gss_svc_max_data_length()` — are useful in determining how large a piece of data can be before it is transformed by security measures and sent “over the wire.” That is, a security transformation such as encryption usually changes the size of a piece of transmitted data (most often enlarging it). To make sure that data won’t be enlarged past a usable size, these two functions — the former is the client-side version, the latter the server-side — return the maximum pre-transformation size for a given transport.

For more information, see the `rpc_gss_max_data_length(3N)` and `rpc_gss_svc_max_data_length(3N)` man pages.

Miscellaneous Functions

Several functions are useful for getting information about the installed security system:

- `rpc_gss_get_mechanisms()` returns a list of installed security mechanisms

- `rpc_gss_is_installed()` checks to see if a specified mechanism is installed
- `rpc_gss_get_mech_info()` returns valid QOPs for a given mechanism

Using these functions gives the programmer latitude in avoiding hard-coding security parameters in applications. (See Table 4-8 and the `rpcsec_gss(3N)` man page for a list of all RPCSEC_GSS functions.)

Associated Files

RPCSEC_GSS makes use of certain files to store information.

The gsscred Table

When a server retrieves the client credentials associated with a request, it can get either the client's principal name (in the form of a `rpc_gss_principal_t` structure pointer) or local UNIX credentials (UID) for that client. Services such as NFS require a local UNIX credential for access checking, but others might not; they can, for example, store the principal name, as a `rpc_gss_principal_t` structure, directly in their own access control lists.

Note - The correspondence between a client's network credential (its principal name) and any local UNIX credential is not automatic — it must be set up explicitly by the local security administrator.

The `gsscred` file contains both the client's UNIX and network (for example, Kerberos V5) credentials. (The latter is the Hex-ASCII representation of the `rpc_gss_principal_t` structure.) It is accessed through XFN; thus, this table can be implemented over files, NIS, or NIS+, or any future name service supported by XFN. In the XFN hierarchy, this table appears as *this_org_unit/service/gsscred*. The `gsscred` table is maintained with the use of the `gsscred` utility, which allows administrators to add and delete users and mechanisms.

/etc/gss/qop **and** */etc/gss/mech*

For convenience, RPCSEC_GSS uses string literals for representing mechanisms and Quality of Protection (QOP) parameters. The underlying mechanisms themselves, however, require mechanisms to be represented as object identifiers and QOPs as 32-bit integers. Additionally, for each mechanism, the shared library that implements the services for that mechanism needs to be specified.

The `/etc/gss/mech` file stores the following information on all installed mechanisms on a system: the mechanism name, in ASCII; the mechanism's OID; the shared library implementing the services provided by this mechanism; and,

optionally, the kernel module implementing the service. A sample line might look like this:

```
kerberos_v5 1.2.840.113554.1.2.2 gl/mech_krb5.so gl_kmech_krb5
```

The `/etc/gss/qop` file stores, for all mechanisms installed, all the QOPs supported by each mechanism, both as an ASCII string as its corresponding 32-bit integer.

Both `/etc/gss/mech` and `/etc/gss/qop` are created when security mechanisms are first installed on a given system.

Because many of the in-kernel RPC routines use non-string values to represent mechanism and QOP, applications can use the `rpc_gss_mech_to_oid()` and `rpc_gss_qop_to_num()` functions to get the non-string equivalents for these parameters, should they need to take advantage of those in-kernel routines.

Using Port Monitors

RPC servers can be started by port monitors such as `inetd` and `listen`. Port monitors listen for requests and spawn servers in response. The forked server process is passed file descriptor 0 on which the request has been accepted. For `inetd`, when the server is done, it may exit immediately or wait a given interval for another service request.

For `listen`, servers should exit immediately after replying because `listen()` always spawns a new process. The following function call creates a `SVCXPRT` handle to be used by the services started by port monitors:

```
transp = svc_tli_create(0, nconf, (struct t_bind *)NULL, 0, 0)
```

`nconf` is the `netconfig` structure of the transport from which the request is received.

Because the port monitors have already registered the service with `rpcbind`, there is no need for the service to register with `rpcbind`. But it must call `svc_reg()` to register the service procedure:

```
svc_reg(transp, PROGNUM, VERSNUM, dispatch, (struct netconfig *)NULL)
```

The `netconfig` structure here is `NULL` to prevent `svc_reg()` from registering the service with `rpcbind`.

Note - Study `rpcgen`-generated server stubs to see the sequence in which these routines are called.

For connection-oriented transports, the following routine provides a lower level interface:

```
transp = svc_fd_create(0, recvsize, sendsize);
```

A 0 file descriptor is the first argument. You can set the value of *recvsize* and *sendsize* to any appropriate buffer size. A 0 for either argument causes a system default size to be chosen. Application servers that do not do any listening of their own use `svc_fd_create()`.

Using inetd

Entries in `/etc/inet/inetd.conf` have different formats for socket-based, TLI-based, and RPC services. The format of `inetd.conf` entries for RPC services is:

```
rpc_prog/vers endpoint_type rpc/proto flags user pathname args
where:
```

TABLE 4-9 RPC inetd Services

<code>rpc_prog/vers</code>	The name of an RPC program followed by a / and the version number or a range of version numbers.
<code>endpoint_type</code>	One of <code>dgram</code> (for connectionless sockets), <code>stream</code> (for connection mode sockets), or <code>tli</code> (for TLI endpoints).
<code>proto</code>	May be * (for all supported transports), a <code>nettype</code> , a <code>netid</code> , or a comma separated list of <code>nettype</code> and <code>netid</code> .
<code>flags</code>	Either <code>wait</code> or <code>nowait</code> .
<code>user</code>	Must exist in the effective <code>passwd</code> database.
<code>athname</code>	Full path name of the server daemon.
<code>args</code>	Arguments to be passed to the daemon on invocation.

For example:

```
rquotad/1 tli rpc/udp wait root /usr/lib/nfs/rquotad rquotad
```

For more information, see the `inetd.conf(4)` man page.

Using the Listener

Use `pmadm` to add RPC services:

```
pmadm -a -p pm_tag -s svctag -i id -v vers \
    -m 'nlsadmin -c command -D -R prog:vers'
```

The arguments are: `-a` means to add a service, `-p pm_tag` specifies a tag associated with the port monitor providing access to the service, `-s svctag` is the server's identifying code, `-i id` is the `/etc/passwd` user name assigned to service `svctag`, `-v ver` is the version number for the port monitor's data base file, and `-m` specifies the `nlsadmin` command to invoke the service. `nlsadmin` can have additional arguments. For example, to add version 1 of a remote program server named `rusersd`, a `pmadm` command is:

```
# pmadm -a -p tcp -s rusers -i root -v 4 \  
-m `nlsadmin -c /usr/sbin/rpc.ruserd -D -R 100002:1`
```

The command is given `root` permissions, installed in version 4 of the `listener` data base file, and is made available over TCP transports. Because of the complexity of the arguments and options to `pmadm`, use a command script or the menu system to add RPC services. To use the menu system, enter `sysadm ports` and choose the `-port_services` option.

After adding a service, the `listener` must be re-initialized before the service is available. To do this, stop and restart the listener, as follows (note that `rpcbind` must be running):

```
# sacadm -k -p pmtag  
# sacadm -s -p pmtag
```

For more information, such as how to set up the listener process, see the `listen(1M)`, `pmadm(1M)`, `sacadm(1M)` and `sysadm(1M)` man pages and the *TCP/IP and Data Communications Administration Guide*.

Multiple Server Versions

By convention, the first version number of a program, `PROG`, is named `PROGVERS_ORIG` and the most recent version is named `PROGVERS`. Program version numbers must be assigned consecutively. Leaving a gap in the program version sequence can cause the search algorithm to not find a matching program version number that is defined.

Version numbers should never be changed by anyone other than the owner of a program. Adding a version number to a program that you do not own can cause severe problems when the owner increments the version number. Sun registers version numbers and answers questions about them (rpc@Sun.com).

Suppose a new version of the `ruser` program returns an unsigned `short` rather than an `int`. If you name this version `RUSERSVERS_SHORT`, a server that wants to support both versions would do a double register. The same server handle is used for both registrations.

CODE EXAMPLE 4-34 Server Handle for Two Versions of Single Routine

```
if (!svc_reg(transp, RUSERSPROG, RUSERSVERS_ORIG,
            nuser, nconf))
{
    fprintf(stderr, "can't register RUSER service\n");
    exit(1);
}
if (!svc_reg(transp, RUSERSPROG, RUSERSVERS_SHORT, nuser,
            nconf)) {
    fprintf(stderr, "can't register RUSER service\n");
    exit(1);
}
```

Both versions can be performed by a single procedure.

CODE EXAMPLE 4-35 Procedure for Two Versions of Single Routine

```
void
nuser(rqstp, transp)
    struct svc_req *rqstp;
    SVCXPRT *transp;
{
    unsigned int nusers;
    unsigned short nusers2;
    switch(rqstp->rq_proc) {
        case NULLPROC:
            if (!svc_sendreply( transp, xdr_void, 0))
                fprintf(stderr, "can't reply to RPC call\n");
            return;
        case RUSERSPROC_NUM:
            /*
             * Code here to compute the number of users
             * and assign it to the variable nusers
             */
            switch(rqstp->rq_vers) {
                case RUSERSVERS_ORIG:
                    if (! svc_sendreply( transp, xdr_u_int, &nusers))
                        fprintf(stderr, "can't reply to RPC call\n");
                    break;
                case RUSERSVERS_SHORT:
                    nusers2 = nusers;
                    if (! svc_sendreply( transp, xdr_u_short, &nusers2))
                        fprintf(stderr, "can't reply to RPC call\n");
                    break;
            }
        default:
            svcerr_noproc(transp);
            return;
    }
    return;
}
```

Multiple Client Versions

Since different hosts may run different versions of RPC servers, a client should be capable of accommodating the variations. For example, one server may run the old

version of RUSERSPROG(RUSERSVERS_ORIG) while another server runs the newer version (RUSERSVERS_SHORT).

If the version on a server does not match the version number in the client creation call, `clnt_call()` fails with an `RPCPROGVERSMISMATCH` error. You can get the version numbers supported by a server and then create a client handle with the appropriate version number. Use either the routine in Code Example 4-36, or `clnt_create_vers()`. See the `rpc(3NSL)` man page for more details.

CODE EXAMPLE 4-36 RPC Versions on Client Side

```
main()
{
    enum clnt_stat status;
    u_short num_s;
    u_int num_l;
    struct rpc_err rpcerr;
    int maxvers, minvers;
    CLIENT *clnt;

    clnt = clnt_create("remote", RUSERSPROG, RUSERSVERS_SHORT,
                     "datagram_v");
    if (clnt == (CLIENT *) NULL) {
        clnt_pcreateerror("unable to create client handle");
        exit(1);
    }
    to.tv_sec = 10;          /* set the time outs */
    to.tv_usec = 0;

    status = clnt_call(clnt, RUSERSPROC_NUM, xdr_void,
                      (caddr_t) NULL, xdr_u_short,
                      (caddr_t)&num_s, to);
    if (status == RPC_SUCCESS) { /* Found latest version number */
        printf("num = %d\n", num_s);
        exit(0);
    }
    if (status != RPC_PROGVERSMISMATCH) { /* Some other error */
        clnt_perror(clnt, "rusers");
        exit(1);
    }
    /* This version not supported */
    clnt_geterr(clnt, &rpcerr);
    maxvers = rpcerr.re_vers.high; /* highest version supported */
    minvers = rpcerr.re_vers.low; /* lowest version supported */
    if (RUSERSVERS_SHORT < minvers || RUSERSVERS_SHORT > maxvers)
    {
        /* doesn't meet minimum standards */
        clnt_perror(clnt, "version mismatch");
        exit(1);
    }
    (void) clnt_control(clnt, CLSET_VERSION, RUSERSVERS_ORIG);
    status = clnt_call(clnt, RUSERSPROC_NUM, xdr_void,
                      (caddr_t) NULL, xdr_u_int, (caddr_t)&num_l, to);
    if (status == RPC_SUCCESS)
        /* We found a version number we recognize */
}
```

(continued)

(Continuation)

```
printf("num = %d\n", num_1);
else {
    clnt_perror(clnt, "rusers");
    exit(1);
}
}
```

Using Transient RPC Program Numbers

Occasionally, it is useful for an application to use RPC program numbers that are generated dynamically. This could be used for implementing callback procedures, for example. In the callback example, a client program typically registers an RPC service using a dynamically generated, or transient, RPC program number and passes this on to a server along with a request. The server will then call back the client program using the transient RPC program number in order to supply the results. Such a mechanism may be necessary if processing the client's request will take a huge amount of time and the client cannot block (assuming it is single-threaded); in this case, the server will acknowledge the client's request, and call back later with the results. Another use of callbacks is to generate periodic reports from a server; the client makes an RPC call to start the reporting, and the server periodically calls back the client with reports using the transient RPC program number supplied by the client program.

Dynamically generated, or transient, RPC program numbers are in the transient range, 0x40000000 - 0x5fffffff. The following routine creates a service based on a transient RPC program for a given transport type. The service handle and the transient rpc program number are returned. The caller supplies the service dispatch routine, the version, and the transport type.

CODE EXAMPLE 4-37 Transient RPC Program—Server Side

```
SVCXPRT *register_transient_prog(dispatch, program, version, netid)
void (*dispatch)(); /* service dispatch routine */
rpcproc_t *program; /* returned transient RPC number */
rpcvers_t version; /* program version */
char *netid; /* transport id */
{
    SVCXPRT *transp;
    struct netconfig *nconf;
    rpcprog_t prognum;
    if ((nconf = getnetconfigt(netid)) == (struct netconfig
*)NULL)
        return ((SVCXPRT *)NULL);
    if ((transp = svc_tli_create(RPC_ANYFD, nconf,
        (struct t_bind *)NULL, 0, 0)) == (SVCXPRT *)NULL) {
```

```

    freenetconfigent(nconf);
    return ((SVCXPRT *)NULL);
}
prognum = 0x40000000;
while (prognum < 0x60000000 && svc_reg(transp, prognum,
version,
    dispatch, nconf) == 0) {
    prognum++;
}
freenetconfigent(nconf);
if (prognum >= 0x60000000) {
    svc_destroy(transp);
    return ((SVCXPRT *)NULL);
}
*program = prognum;
return (transp);
}

```

Multithreaded RPC Programming

This manual does not cover basic topics and code examples for the Solaris implementation of multithread programming. Instead, refer to the *Multithreaded Programming Guide* for background on the following topics:

- Thread creation
- Scheduling
- Synchronization
- Signals
- Process resources
- Light-weight processes (lwp)
- Concurrency
- Data locking strategies

TI-RPC supports multithreaded RPC servers in releases since Solaris 2.4. The difference between a multithreaded server and a single-threaded server is that a multithreaded server uses threading technology to process incoming client requests concurrently. Multithreaded servers can have higher performance and availability compared with single-threaded servers.

The section “MT Server Overview” on page 141 is a good place to start reading about the interfaces available in this release.

MT Client Overview

In a multithread client program, a thread can be created to issue each RPC request. When multiple threads share the same client handle, only one thread at a time will be able to make an RPC request. All other threads will wait until the outstanding request is complete. On the other hand, when multiple threads make RPC requests using different client handles, the requests are carried out concurrently. Figure 4-2 illustrates a possible timing of a multithreaded client implementation consisting of two client threads using different client handles.

Code Example 4-38 shows the client side implementation of a multithreaded `rstat` program. The client program creates a thread for each host. Each thread creates its own client handle and makes various RPC calls to the given host. Because the client threads are using different handles to make the RPC calls, they can carry out the RPC calls concurrently.

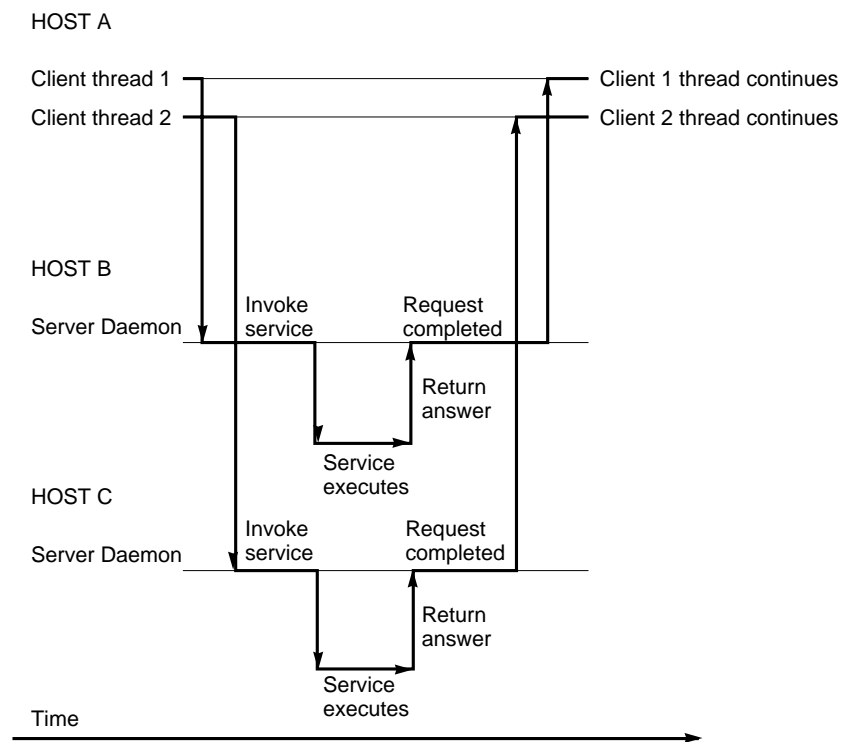

Figure 4-2 Two Client Threads Using Different Client Handles (Real time)

Note - You must link in the thread library when writing any RPC multi-threaded-safe application. The thread library must be the last named library on the link line. To do this, specify the `-lthread` option in the `compile` command.

Compile the program in Code Example 4-38 by typing:

```
$ cc rstat.c -lnsl -lthread
```

CODE EXAMPLE 4-38 Client for MT rstat

```
/* @(#)rstat.c 2.3 93/11/30 4.0 RPCSRC */
/*
 * Simple program that prints the status of a remote host,
 * in a format similar to that used by the 'w' command.
 */

#include <thread.h> /* thread interfaces defined */
#include <synch.h> /* mutual exclusion locks defined */
#include <stdio.h>
#include <sys/param.h>
#include <rpc/rpc.h>
#include <rpcsvc/rstat.h>
#include <errno.h>

mutex_t tty; /* control of tty for printf's */
cond_t cv_finish;
int count = 0;

main(argc, argv)
int argc;
char **argv;
{
    int i;
    thread_t tid;
    void *do_rstat();

    if (argc < 2) {
        fprintf(stderr, ``usage: %s \\'host\'' [...]\\n'', argv[0]);
        exit(1);
    }

    mutex_lock(&tty);

    for (i = 1; i < argc; i++) {
        if (thr_create(NULL, 0, do_rstat, argv[i], 0, &tid) < 0) {
            fprintf(stderr, ``thr_create failed: %d\\n'', i);
            exit(1);
        } else
            fprintf(stderr, ``tid: %d\\n'', tid);
    }

    while (count < argc-1) {
        printf(``argc = %d, count = %d\\n'', argc-1, count);
        cond_wait(&cv_finish, &tty);
    }

    exit(0);
}

bool_t rstatproc_stats();
```

(continued)

(Continuation)

```
void *
do_rstat(host)
char *host;
{
    CLIENT *rstat_clnt;
    statstime host_stat;
    bool_t rval;
    struct tm *tmp_time;
    struct tm host_time;
    struct tm host_uptime;
    char days_buf[16];
    char hours_buf[16];

    mutex_lock(&tty);
    printf(``%s: starting\n``, host);
    mutex_unlock(&tty);

    /* client handle to rstat */
    rstat_clnt = clnt_create(host, RSTATPROG, RSTATVERS_TIME,
        ``udp``);
    if (rstat_clnt == NULL) {
        mutex_lock(&tty); /* get control of tty */
        clnt_pcreateerror(host);
        count++;
        cond_signal(&cv_finish);
        mutex_unlock(&tty); /* release control of tty */

        thr_exit(0);
    }

    rval = rstatproc_stats(NULL, &host_stat, rstat_clnt);
    if (!rval) {
        mutex_lock(&tty); /* get control of tty */
        clnt_perror(rstat_clnt, host);
        count++;
        cond_signal(&cv_finish);
        mutex_unlock(&tty); /* release control of tty */

        thr_exit(0);
    }

    tmp_time = localtime_r(&host_stat.curtime.tv_sec,
        &host_time);

    host_stat.curtime.tv_sec = host_stat.boottime.tv_sec;

    tmp_time = gmtime_r(&host_stat.curtime.tv_sec,
        &host_uptime);

    if (host_uptime.tm_yday != 0)
        sprintf(days_buf, ``%d day%s, `` , host_uptime.tm_yday,
```

(continued)

(Continuation)

```
        (host_uptime.tm_yday > 1) ? ``s`` : ````);
else
    days_buf[0] = `0`;

if (host_uptime.tm_hour != 0)
    sprintf(hours_buf, ``%2d:%02d``,
        host_uptime.tm_hour, host_uptime.tm_min);

else if (host_uptime.tm_min != 0)
    sprintf(hours_buf, ``%2d mins``, host_uptime.tm_min);
else

    hours_buf[0] = `0`;

mutex_lock(&tty); /* get control of tty */
printf(``s: `` , host);
printf(`` %2d:%02d%cm up %s% load average: %.2f %.2f %.2f\n``,
    (host_time.tm_hour > 12) ? host_time.tm_hour - 12

    : host_time.tm_hour,
    host_time.tm_min,
    (host_time.tm_hour >= 12) ? `p`
    : `a`,
    days_buf,
    hours_buf,
    (double)host_stat.avenrun[0]/FSCALE,
    (double)host_stat.avenrun[1]/FSCALE,
    (double)host_stat.avenrun[2]/FSCALE);
count++;
cond_signal(&cv_finish);
mutex_unlock(&tty); /* release control of tty */
clnt_destroy(rstat_clnt);

sleep(10);
thr_exit(0);
}

/* Client side implementation of MT rstat program */
/* Default timeout can be changed using clnt_control() */
static struct timeval TIMEOUT = { 25, 0 };

bool_t
rstatproc_stats(argp, clnt_resp, clnt)
void *argp;
statstime *clnt_resp;
CLIENT *clnt;
{

memset((char *)clnt_resp, 0, sizeof (statstime));
if (clnt_call(clnt, RSTATPROC_STATS,
    (xdrproc_t) xdr_void, (caddr_t) argp,
    (xdrproc_t) xdr_statstime, (caddr_t) clnt_resp,
```

(continued)

(Continuation)

```
TIMEOUT) != RPC_SUCCESS) {  
    return (FALSE);  
}  
return (TRUE);  
}
```

MT Server Overview

Prior to Solaris 2.4, RPC servers were single threaded. That is, they process client requests sequentially, as the requests come in. For example, if two requests come in, and the first takes 30 seconds to process, and the second takes only 1 second to process, the client that made the second request will still have to wait for the first request to complete before it receives a response. This is not desirable, especially in a multiprocessor server environment, where each CPU could be processing a different request simultaneously; or in a situation where one request is waiting for I/O to complete, other requests could be processed by the server.

Releases since Solaris 2.4 provide facilities in the RPC library for service developers to create multithreaded servers that deliver better performance to end users. Two modes of server multithreading are supported in TI-RPC: the Automatic MT mode and the User MT mode.

In the Auto mode, the server automatically creates a new thread for every incoming client request. This thread processes the request, sends a response, and exits. In the User mode, the service developer decides how to create and manage threads for concurrently processing the incoming client requests. The Auto mode is much easier to use than the User mode, but the User mode offers more flexibility for service developers with special requirements.

Note - You must link in the thread library when writing RPC multithreaded-safe applications. The thread library must be the last named library on the link line. To do this, specify the `-lthread` option in the compile command.

The two calls that support server multithreading are `rpc_control()` and `svc_done()`. The `rpc_control()` call is used to set the MT mode, either Auto or User mode. If the server uses Auto mode, it does not need to invoke `svc_done()` at all. In User mode, `svc_done()` must be invoked after each client request is processed, so that the server can reclaim the resources from processing the request. In addition, multithreaded RPC servers must call on `svc_run()`. Note that `svc_getreqpoll()` and `svc_getreqset()` are unsafe in MT applications.

Note - If the server program does not invoke any of the MT interface calls, it remains in single-threaded mode, which is the default mode.

You are required to make RPC server procedures multithreaded safe regardless of which mode the server is using. Usually, this means that all static and global variables need to be protected with mutex locks. Mutual exclusion and other synchronization APIs are defined in `synch.h`. See the `condition(3THR)`, `rwlock(3THR)`, and `mutex(3THR)` man pages for a list of the various synchronization interfaces.

Figure 4-3 illustrates a possible timing of a server implemented in one of the MT modes of operation.

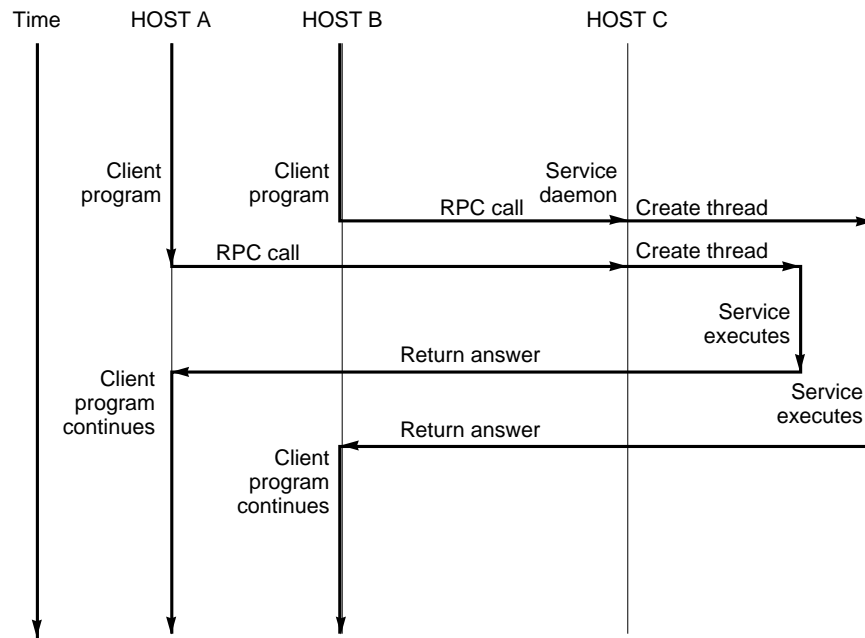

Figure 4-3 MT RPC Server Timing Diagram

Sharing the Service Transport Handle

The service transport handle, `SVCXPRT`, contains a single data area for decoding arguments and encoding results. Therefore, in the default, single-threaded mode, this structure cannot be freely shared between threads that call functions that perform these operations. However, when a server is operating in the MT Auto or User modes, a copy of this structure is passed to the service dispatch procedure in order to enable concurrent request processing. Under these circumstances, some routines which would otherwise be unsafe, become safe. Unless otherwise noted, the server

interfaces are generally MT safe. See the `rpc_svc_calls(3NSL)` man page for more details on safety for server-side interfaces.

MT Auto Mode

In the Automatic mode, the RPC library creates and manages threads. The service developer invokes a new interface call, `rpc_control()`, to put the server into MT Auto mode before invoking the `svc_run()` call. In this mode, the programmer needs only to ensure that service procedures are MT safe.

`rpc_control()` allows applications to set and modify global RPC attributes. At present, it supports only server-side operations. Table 4-10 shows the `rpc_control()` operations defined for Auto mode. See also the `rpc_control(3N)` man page for additional information.

TABLE 4-10 `rpc_control()` Library Routines

<code>RPC_SVC_MTMODE_SET()</code>	Set multithread mode
<code>RPC_SVC_MTMODE_GET()</code>	Get multithread mode
<code>RPC_SVC_THRMAX_SET()</code>	Set Maximum number of threads
<code>RPC_SVC_THRMAX_GET()</code>	Get Maximum number of threads
<code>RPC_SVC_THRTOTAL_GET()</code>	Total number of threads currently active
<code>RPC_SVC_THRCREATES_GET()</code>	Cumulative total number of threads created by the RPC library
<code>RPC_SVC_THRERRORS_GET()</code>	Number of <code>thr_create</code> errors within RPC library

Note - All of the get operations in Table 4-10, except `RPC_SVC_MTMODE_GET()`, apply only to the Auto MT mode. If used in MT User mode or the single-threaded default mode, the results of the operations may be undefined.

By default, the maximum number of threads that the RPC server library creates at any time is 16. If a server needs to process more than 16 client requests concurrently, the maximum number of threads must be set to the desired number. This parameter may be set at any time by the server, and it allows the service developer to put an upper bound on the thread resources consumed by the server. Code Example 4-39 is an example RPC program written in MT Auto mode. In this case, the maximum number of threads is set at 20.

MT performance is enhanced if the function `svc_getargs()` is called by every procedure other than `NULLPROCS`, even if there are no arguments (`xdr_void()` may be used in this case). This is true for both the MT Auto and MT User modes. For more information on this call, see the `rpc_svc_calls(3NSL)` man page.

Code Example 4-39 illustrates the server in MT Auto mode.

Note - You must link in the thread library when writing RPC multithreaded-safe applications. The thread library must be the last named library on the link line. To do this, specify the `-lthread` option in the compile command.

Compile the program in Code Example 4-39 by typing:

```
$ cc time_svc.c -lnsl -lthread
```

CODE EXAMPLE 4-39 Server for MT Auto Mode

```
#include <stdio.h>
#include <rpc/rpc.h>
#include <synch.h>
#include <thread.h>
#include "time_prot.h"

void time_prog();

main(argc, argv)
int argc;
char *argv[];
{
    int transpnum;
    char *nettype;
    int mode = RPC_SVC_MT_AUTO;
    int max = 20; /* Set maximum number of threads to 20 */

    if (argc > 2) {
        fprintf(stderr, "usage: %s [nettype]\n", argv[0]);
        exit(1);
    }

    if (argc == 2)
        nettype = argv[1];
    else
        nettype = "netpath";

    if (!rpc_control(RPC_SVC_MTMODE_SET, &mode)) {
        printf("RPC_SVC_MTMODE_SET: failed\n");
        exit(1);
    }
    if (!rpc_control(RPC_SVC_THRMAX_SET, &max)) {
        printf("RPC_SVC_THRMAX_SET: failed\n");
        exit(1);
    }
    transpnum = svc_create( time_prog, TIME_PROG, TIME_VERS,
```

(continued)

(Continuation)

```
    nettype);

    if (transpnum == 0) {
        fprintf(stderr, "%s: cannot create %s service.\n",
            argv[0], nettype);
        exit(1);
    }
    svc_run();
}

/*
 * The server dispatch function.
 * The RPC server library creates a thread which executes
 * the server dispatcher routine time_prog(). After which
 * the RPC library will take care of destroying the thread.
 */

static void
time_prog(rqstp, transp)
    struct svc_req *rqstp;
    SVCXPRT *transp;
{
    switch (rqstp->rq_proc) {
        case NULLPROC:
            svc_sendreply(transp, xdr_void, NULL);
            return;
        case TIME_GET:
            dotime(transp);
            break;
        default:
            svcerr_noproc(transp);
            return;
    }
}

dotime(transp)
SVCXPRT *transp;
{
    struct timev rslt;
    time_t thetime;

    thetime = time((time_t *)0);
    rslt.second = thetime % 60;
    thetime /= 60;
    rslt.minute = thetime % 60;
    thetime /= 60;
    rslt.hour = thetime % 24;
    if (!svc_sendreply(transp, xdr_timev, (caddr_t) &rslt)) {
        svcerr_systemerr(transp);
    }
}
}
```

(continued)

(Continuation)

Code Example 4-40 shows the `time_prot.h` header file for the server.

CODE EXAMPLE 4-40 MT Auto Mode:time_prot.h

```
#include <rpc/types.h>

struct timev {
    int second;
    int minute;
    int hour;
};

typedef struct timev timev;
bool_t xdr_timev();

#define TIME_PROG 0x40000001
#define TIME_VERS 1
#define TIME_GET 1
```

MT User Mode

In MT User mode, the RPC library will not create any threads. This mode works, in principle, like the single-threaded, or default mode. The only difference is that it passes copies of data structures (such as the transport service handle to the service dispatch routine) to be MT safe.

The RPC server developer takes the responsibility for creating and managing threads through the thread library. In the dispatch routine, the service developer can assign the task of procedure execution to newly created or existing threads. The `thr_create()` API is used to create threads having various attributes. All thread library interfaces are defined in `thread.h`. See the `pthread_create(3THR)` man page for more details.

There is a lot of flexibility available to the service developer in this mode. Threads can now have different stack sizes based on service requirements. Threads may be bound. Different procedures may be executed by threads with different characteristics. The service developer may choose to run some services single threaded. The service developer may choose to do special thread-specific signal processing.

As in the Auto mode, the `rpc_control()` library call is used to turn on User mode. Note that the `rpc_control()` operations shown in Table 4-10 (except for

`RPC_SVC_MTMODE_GET()` apply only to MT Auto mode. If used in MT User mode or the single-threaded default mode, the results of the operations may be undefined.

Freeing Library Resources in User Mode

In the MT User mode, service procedures must invoke `svc_done()` before returning. `svc_done()` frees resources allocated to service a client request directed to the specified service transport handle. This function is invoked after a client request has been serviced, or after an error or abnormal condition that prevents a reply from being sent. After `svc_done()` is invoked, the service transport handle should not be referenced by the service procedure. Code Example 4-41 shows a server in MT User mode.

Note - `svc_done()` must only be called within MT User mode. For more information on this call, see the `rpc_svc_calls(3NSL)` man page.

CODE EXAMPLE 4-41 MT User Mode: `rpc_test.h`

```
#define SVC2_PROG 0x30000002
#define SVC2_VERS 1
#define SVC2_PROC_ADD 1)
#define SVC2_PROC_MULT 2

struct intpair {
    u_short a;
    u_short b;
};

typedef struct intpair intpair;

struct svc2_add_args {
    int argument;
    SVCXPRT *transp;
};

struct svc2_mult_args {
    intpair mult_argument;
    SVCXPRT *transp;
};

extern bool_t xdr_intpair();

#define NTHREADS_CONST 500
```

Code Example 4-42 is the client for MT User mode.

CODE EXAMPLE 4-42 Client for MT User Mode

```
#define _REENTRANT
#include <stdio.h>
#include <rpc/rpc.h>
```

(Continuation)

```
#include <sys/uio.h>
#include <netconfig.h>
#include <netdb.h>
#include <rpc/nettype.h>
#include <thread.h>
#include "rpc_test.h"
void *doclient();
int NTHREADS;
struct thread_info {
    thread_t client_id;
    int client_status;
};
struct thread_info save_thread[NTHREADS_CONST];
main(argc, argv)
    int argc;
    char *argv[];
{
    int index, ret;
    int thread_status;
    thread_t departedid, client_id;
    char *hosts;
    if (argc < 3) {
        printf("Usage: do_operation [n] host\n");
        printf("\twhere n is the number of threads\n");
        exit(1);
    } else
        if (argc == 3) {
            NTHREADS = NTHREADS_CONST;
            hosts = argv[1]; /* live_host */
        } else {
            NTHREADS = atoi(argv[1]);
            hosts = argv[2];
        }
    for (index = 0; index < NTHREADS; index++){
        if (ret = thr_create(NULL, NULL, doclient,
            (void *) hosts, THR_BOUND, &client_id)){
            printf("thr_create failed: return value %d", ret);
            printf(" for %dth thread\n", index);
            exit(1);
        }
        save_thread[index].client_id = client_id;
    }
    for (index = 0; index < NTHREADS; index++){
        if (thr_join(save_thread[index].client_id, &departedid,
            (void *)
            &thread_status)){
            printf("thr_join failed for thread %d\n",
                save_thread[index].client_id);
            exit(1);
        }
        save_thread[index].client_status = thread_status;
    }
}
```

(continued)

(Continuation)

```
void *doclient(host)
char *host;
{
    struct timeval tout;
    enum clnt_stat test;
    int result = 0;
    u_short mult_result = 0;
    int add_arg;
    int EXP_RSLT;
    intpair pair;
    CLIENT *clnt;
    if ((clnt = clnt_create(host, SVC2_PROG, SVC2_VERS, "udp"
==NULL) {
        clnt_pcreateerror("clnt_create error: ");
        thr_exit((void *) -1);
    }
    tout.tv_sec = 25;
    tout.tv_usec = 0;
    memset((char *) &result, 0, sizeof (result));
    memset((char *) &mult_result, 0, sizeof (mult_result));
    if (thr_self() % 2){
        EXP_RSLT = thr_self() + 1;
        add_arg = thr_self();
        test = clnt_call(clnt, SVC2_PROC_ADD, (xdrproc_t) xdr_int,
(caddr_t) &add_arg, (xdrproc_t) xdr_int, (caddr_t) &result,
tout);
    } else {
        pair.a = (u_short) thr_self();
        pair.b = (u_short) 1;
        EXP_RSLT = pair.a * pair.b;
        test = clnt_call(clnt, SVC2_PROC_MULT, (xdrproc_t)
xdr_intpair,
(caddr_t) &pair, (xdrproc_t) xdr_u_short,
(caddr_t) &mult_result, tout);
        result = mult_result;
    }
    if (test != RPC_SUCCESS) {
        printf("THREAD: %d clnt_call hav
        thr_exit((void *) -1);
    };
    thr_exit((void *) 0);
}
```

Code Example 4-43 shows the server side in MT User mode. MT performance is enhanced if the function `svc_getargs()` is called by every procedure other than `NULLPROC`, even if there are no arguments (`xdr_void` may be used in this case). This is true for both the MT Auto and MT User modes. For more information on this call, see the `rpc_svc_calls(3NSL)` man page.

Note - You must link in the thread library when writing RPC multithreaded-safe applications. The thread library must be the last named library on the link line. To do this, specify the `-lthread` option in the compile command.

CODE EXAMPLE 4-43 Server for MT User Mode

```
#define _REENTRANT
#include <stdio.h>
#include <rpc/rpc.h>
#include <sys/types.h>
#include <netinet/in.h>
#include <sys/uio.h>
#include <signal.h>
#include <thread.h>
#include "operations.h"

SVCXPRT *xpvt;
void add_mult_prog();
void *svc2_add_worker();
void *svc2_mult_worker();
main(argc, argv)
    int argc;
    char **argv;
{
    int transpnum;
    char *nettype;
    int mode = RPC_SVC_MT_USER;
    if(rpc_control(RPC_SVC_MTMODE_SET,&mode) == FALSE){
        printf(" rpc_control is failed to set AUTO mode\n");
        exit(0);
    }
    if (argc > 2) {
        fprintf(stderr, "usage: %s [nettype]\n", argv[0]);
        exit(1);
    }
    if (argc == 2)
        nettype = argv[1];
    else
        nettype = "netpath";
    transpnum = svc_create(add_mult_prog, SVC2_PROG,
        SVC2_VERS, nettype);
    if (transpnum == 0) {
        fprintf(stderr, "%s: cannot create %s service.\n", argv[0],
            nettype);
        exit(1);
    }
    svc_run();
}
void add_mult_prog (rqstp, transp)
    struct svc_req *rqstp;
    SVCXPRT *transp;
{
    int argument;
```

(continued)

(Continuation)

```
u_short mult_arg();
intpair mult_argument;
bool_t (*xdr_argument)();
struct svc2_mult_args *sw_mult_data;
struct svc2_add_args *sw_add_data;
int ret;
thread_t worker_id;
switch (rqstp->rq_proc){
case NULLPROC:
    svc_sendreply(transp, xdr_void, (char *) 0);
    svc_done(transp);
    break;
case SVC2_PROC_ADD:
    xdr_argument = xdr_int;
    (void) memset((char *) &argument, 0, sizeof (argument));
    if (!svc_getargs(transp, xdr_argument,
    (char *) &argument)){
        printf("problem with getargs\n");
        svcerr_decode(transp);
        exit(1);
    }
    sw_add_data = (struct svc2_add_args *)
    malloc(sizeof (struct svc2_add_args));
    sw_add_data->transp = transp;
    sw_add_data->argument = argument;
    if (ret = thr_create(NULL, THR_MIN_STACK + 16 * 1024,
    svc2_add_worker, (void *) sw_add_data, THR_DETACHED,
        printf("SERVER: thr_create failed:");
        printf(" return value %d", ret);
        printf(" for add thread\n");
        exit(1);
    }
    break;
case SVC2_PROC_MULT:
    xdr_argument = xdr_intpair;
    (void) memset((char *) &mult_argument, 0,
    sizeof (mult_argument));
    if (!svc_getargs(transp, xdr_argument,
    (char *) &mult_argument)){
        printf("problem with getargs\n");
        svcerr_decode(transp);
        exit(1);
    }
    sw_mult_data = (struct svc2_mult_args *)
    malloc(sizeof (struct svc2_mult_args));
    sw_mult_data->transp = transp;
    sw_mult_data->mult_argument.a = mult_argument.a;
    sw_mult_data->mult_argument.b = mult_argument.b;
    if (ret = thr_create(NULL, THR_MIN_STACK + 16 * 1024,
    svc2_mult_worker, (void *) sw_mult_data, THR_DETACHED,
    &worker_id)){
        printf("SERVER: thr_create failed:");
        printf("return value %d", ret);
    }
}
```

(continued)

(Continuation)

```
    printf("for multiply thread\n");
    exit(1);
    break;
default:
    svcerr_noproc(transp);
    svc_done(transp);
    break;
}
}
u_short mult_arg();
int add_one();
void *svc2_add_worker(add_arg)
struct svc2_add_args *add_arg;
{ int *result;
  bool_t (*xdr_result)();
  xdr_result = xdr_int;
  result = *malloc(sizeof (int));
  *result = add_one(add_arg->argument);
  if (!svc_sendreply(add_arg->transp, xdr_result,
    (caddr_t) result)){
    printf("sendreply failed\n");
    svcerr_systemerr(add_arg->transp);
    svc_done(add_arg->transp);
    thr_exit((void *) -1);
  }
  svc_done(add_arg->transp);
  thr_exit((void *) 0);
}
void *svc2_mult_worker(m_arg)
struct svc2_mult_args *m_arg;
{
  u_short *result;
  bool_t (*xdr_result)();
  xdr_result = xdr_u_short;
  result = (u_short *) malloc(sizeof (u_short));
  *result = mult_arg(&m_arg->mult_argument);
  if (!svc_sendreply(m_arg->transp, xdr_result,
    (caddr_t) result)){
    printf("sendreply failed\n");
    svcerr_systemerr(m_arg->transp);
    svc_done(m_arg->transp);
    thr_exit((void *) -1);
  }
  svc_done(m_arg->transp);
  thr_exit((void *) 0);
}
u_short mult_arg(pair)
intpair *pair;
{
  u_short result;
  result = pair->a * pair->b;
  return (result);}
}
```

(continued)

(Continuation)

```
int add_one(arg)
int arg;
{
return (++arg);
}
```

Connection-Oriented Transports

Code Example 4-44 copies a file from one host to another. The RPC `send()` call reads standard input and sends the data to the server `receive()`, which writes the data to standard output. This also illustrates an XDR procedure that behaves differently on serialization and on deserialization. A connection-oriented transport is used.

CODE EXAMPLE 4-44 Remote Copy (Two-Way XDR Routine)

```
/*
 * The xdr routine:
 *   on decode, read wire, write to fp
 *   on encode, read fp, write to wire
 */
#include <stdio.h>
#include <rpc/rpc.h>

bool_t
xdr_rcp(xdrs, fp)
XDR *xdrs;
FILE *fp;
{
    unsigned long size;
    char buf[BUFSIZ], *p;

    if (xdrs->x_op == XDR_FREE)          /* nothing to free */
        return(TRUE);
    while (TRUE) {
        if (xdrs->x_op == XDR_ENCODE) {
            if ((size = fread( buf, sizeof( char ), BUFSIZ, fp))
                == 0 && ferror(fp)) {
                fprintf(stderr, "can't fread\n");
                return(FALSE);
            }
        }
    }
}
```

(continued)

(Continuation)

```
    } else
        return(TRUE);
    }
    p = buf;
    if (! xdr_bytes( xdrs, &p, &size, BUFSIZ))
        return(0);
    if (size == 0)
        return(1);
    if (xdrs->x_op == XDR_DECODE) {
        if (fwrite( buf, sizeof(char), size, fp) != size) {
            fprintf(stderr, "can't fwrite\n");
            return(FALSE);
        } else
            return(TRUE);
    }
}
}
```

In Code Example 4-45 and Code Example 4-46, the serializing and deserializing are done only by the `xdr_rcp()` routine shown in Code Example 4-44.

CODE EXAMPLE 4-45 Remote Copy Client Routines

```
/* The sender routines */
#include <stdio.h>
#include <netdb.h>
#include <rpc/rpc.h>
#include <sys/socket.h>
#include <sys/time.h>
#include "rcp.h"

main(argc, argv)
int argc;
char **argv;
{
    int xdr_rcp();

    if (argc != 2 7) {
        fprintf(stderr, "usage: %s servername\n", argv[0]);
        exit(1);
    }
    if( callcots( argv[1], RCPPROG, RCPPROC, RCPVERS, xdr_rcp,
        stdin,
        xdr_void, 0 ) != 0 )
        exit(1);
    exit(0);
}
```

(continued)

(Continuation)

```
callcots(host, prognum, procnum, versnum, inproc, in, outproc,
out)
char *host, *in, *out;
xdrproc_t inproc, outproc;
{
enum clnt_stat clnt_stat;
register CLIENT *client;
struct timeval total_timeout;

if ((client = clnt_create( host, prognum, versnum,
"circuit_v"
== (CLIENT *) NULL)) {
clnt_pcreateerror("clnt_create");
return(-1);
}
total_timeout.tv_sec = 20;
total_timeout.tv_usec = 0;
clnt_stat = clnt_call(client, procnum, inproc, in, outproc,
out,
total_timeout);
clnt_destroy(client);
if (clnt_stat != RPC_SUCCESS)
clnt_perror("callcots");
return((int)clnt_stat);
}
```

The receiving routines are defined in Code Example 4-46. Note that in the server, `xdr_rcp()` did all the work automatically.

CODE EXAMPLE 4-46 Remote Copy Server Routines

```
/*
 * The receiving routines
 */
#include <stdio.h>
#include <rpc/rpc.h>
#include "rcp.h"

main()
{
void rcp_service();
if (svc_create(rpc_service, RCPPROG, RCPVERS, "circuit_v") == 0) {
fprintf(stderr, "svc_create: errpr\n");
exit(1);
}
svc_run(); /* never returns */
}
```

(continued)

(Continuation)

```
    fprintf(stderr, "svc_run should never return\n");
}

void
rcp_service(rqstp, transp)
    register struct svc_req *rqstp;
    register SVCXPRT *transp;
{
    switch(rqstp->rq_proc) {
    case NULLPROC:
        if (svc_sendreply(transp, xdr_void, (caddr_t) NULL) == FALSE)
            fprintf(stderr, "err: rcp_service");
        return;
    case RCPPROC:
        if (!svc_getargs( transp, xdr_rcp, stdout)) {
            svcerr_decode(transp);
            return();
        }
        if(!svc_sendreply(transp, xdr_void, (caddr_t) NULL)) {
            fprintf(stderr, "can't reply\n");
            return();
        }
        return();
    default:
        svcerr_noproc(transp);
        return();
    }
}
}
```

Memory Allocation With XDR

XDR routines normally serialize and deserialize data. XDR routines often automatically allocate memory and free automatically allocated memory. The convention is to use a `NULL` pointer to an array or structure to indicate that an XDR function must allocate memory when deserializing. The next example, `xdr_chararr1()`, processes a fixed array of bytes with length `SIZE` and cannot allocate memory if needed:

```
xdr_chararr1(xdrsp, chararr)
    XDR *xdrsp;
    char chararr[];
```

```

{
    char *p;
    int len;

    p = chararr;
    len = SIZE;
    return (xdr_bytes(xdrsp, &p, &len, SIZE));
}

```

If space has already been allocated in *chararr*, it can be called from a server like this:

```

char chararr[SIZE];
svc_getargs(transp, xdr_chararr1, chararr);

```

Any structure through which data is passed to XDR or RPC routines must be allocated so that its base address is at an architecture-dependent boundary. An XDR routine that does the allocation must be written so that it can:

- Allocate memory when a caller requests
- Return the pointer to any memory it allocates

In the following example, the second argument is a `NULL` pointer, meaning that memory should be allocated to hold the data being deserialized.

```

xdr_chararr2(xdrsp, chararrp)
    XDR *xdrsp;
    char **chararrp;
{
    int len;

    len = SIZE;
    return (xdr_bytes(xdrsp, chararrp, &len, SIZE));
}

```

The corresponding RPC call is:

```

char *arrptr;
arrptr = NULL;
svc_getargs(transp, xdr_chararr2, &arrptr);
/*
 * Use the result here
 */
svc_freeargs(transp, xdr_chararr2, &arrptr);

```

After use, the character array should be freed through `svc_freeargs()`. `svc_freeargs()` does nothing if passed a `NULL` pointer as its second argument.

To summarize:

- An XDR routine normally serializes, deserializes, and frees memory.
- `svc_getargs()` calls the XDR routine to deserialize.

- `svc_freeargs()` calls the XDR routine to free memory.

Porting From TS-RPC to TI-RPC

The transport-independent RPC (TI-RPC) routines allow the developer stratified levels of access to the transport layer. The highest-level routines provide complete abstraction from the transport and provide true transport-independence. Lower levels provide access levels similar to the TI-RPC of previous releases.

This section is an informal guide to porting transport-specific RPC (TS-RPC) applications to TI-RPC. Table 4-11 shows the differences between selected routines and their counterparts. For information on porting issues concerning sockets and transport layer interface (TLI), see the *Transport Interfaces Programming Guide*.

Porting an Application

An application based on either TCP or UDP can run in binary-compatibility mode. For some applications you only recompile and relink all source files. This may be true of applications that use simple RPC calls and use no socket or TCP or UDP specifics.

Some editing and new code may be needed if an application depends on socket semantics or features specific to TCP or UDP. Examples use the format of host addresses or rely on the Berkeley UNIX concept of privileged ports.

Applications that are dependent on the internals of the library or the socket implementation, or depend on specific transport addressing probably require more effort to port and may require substantial modification.

Benefits of Porting

Some of the benefits of porting are:

- Applications transport independence means they operate over more transports than before.
- Use of new interfaces make your application more efficient.
- Binary compatibility is less efficient than native mode.
- Old interfaces could removed from future releases.

IPv6 Considerations for RPC

IPv6 is the successor of IPv4, the most commonly used layer 2 protocol in today's internet technology. IPv6 is also known as IP next generation (IPng). For more information, see *System Administration Guide, Volume 3*.

Both IPv4 and IPv6 are available to users. Applications choose which "stack" to use when using COTS (Connection-oriented-transport service). They can choose TCP or CLTS (connection-less-transport service).

The following figure illustrates a typical RPC application running over an IPv4 or IPv6 protocol stack.

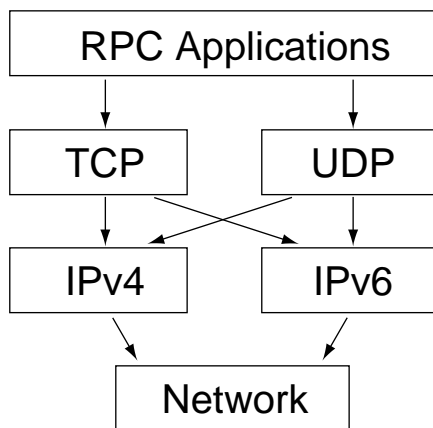

Figure 4-4 RCP Applications

IPv6 is supported only for TI-RPC applications. TS-RPC does not currently support IPv6. Transport selection in TI-RPC is governed by either the `NETPATH` environment variable or in `/etc/netconfig`. The selection of TCP or UDP instead of IPv4 or IPv6 is dependent on the order in which the corresponding entries appear in `/etc/netconfig`. There are two new entries associated with IPv6 in `/etc/netconfig`, and by default they are the first two entries of the file. TI-RPC first tries IPv6. Failing that, it falls back to IPv4. Doing so requires no change in the RPC application itself provided that it doesn't have any knowledge of the transport and is written using the top level interface.

<code>clnt_create()</code>	<code>svc_create()</code>
<code>clnt_call()</code>	<code>clnt_create_timed()</code>

This interface chooses IPv6 automatically if IPv6 is the first item in `/etc/netconfig`.

IPv6 enables application only uses RPCBIND protocol V3 and V4 to locate the service bar and number.

<code>clnt_tli_create()</code>	<code>svc_tli_create()</code>
<code>clnt_dg_create()</code>	<code>svc_dg_create()</code>
<code>clnt_vc_create()</code>	<code>svc_vc_create()</code>

It might be necessary to port the code if one of the above interfaces is used.

Porting Issues

libnsl Library

`libc` no longer includes networking functions. `libnsl` must be explicitly specified at compile time to link the network services routines.

Old Interfaces

Many old interfaces are supported in the `libnsl` library, but they work only with TCP or UDP transports. To take advantage of new transports, you must use the new interfaces.

Name-to-Address Mapping

Transport independence requires opaque addressing. This has implications for applications that interpret addresses.

Differences Between TI-RPC and TS-RPC

The major differences between transport-independent RPC and transport-specific RPC are illustrated in Table 4-11. Also see section “Comparison Examples” on page 164 for code examples comparing TS-RPC with TI-RPC.

TABLE 4-11 Differences Between TI-RPC and TS-RPC

Category	TI-RPC	TS- RPC
Default Transport Selection	TI-RPC uses the TLI interface.	TS-RPC uses the socket interface.
RPC Address Binding	TI-RPC uses <code>rpcbind()</code> for service binding. <code>rpcbind()</code> keeps address in universal address format.	TS-RPC uses <code>portmap</code> for service binding.
Transport Information	Transport information is kept in a local file, <code>/etc/netconfig</code> . Any transport identified in <code>netconfig</code> is accessible.	Only TCP and UDP transports are supported.
Loopback Transports	<code>rpcbind</code> service requires a secure loopback transport for server registration	TS-RPC services do not require a loopback transport.
Host Name Resolution	The order of host name resolution in TI-RPC depends on the order of dynamic libraries identified by entries in <code>/etc/netconfig</code> .	Host name resolution is done by name services. The order is set by the state of the hosts database.
File Descriptors	Descriptors are assumed to be TLI endpoints.	Descriptors are assumed to be sockets.
<code>rpcgen</code>	The TI-RPC <code>rpcgen</code> tool adds support for multiple arguments, pass-by values, sample client files, and sample server files.	<code>rpcgen</code> in SunOS 4.1 and previous releases do not support the features listed for TI-RPC <code>rpcgen</code> .
Libraries	TI-RPC requires that applications be linked to the <code>libnsl</code> library.	All TS-RPC functionality is provided in <code>libc</code> .
MT Support	Multithreaded RPC clients and servers are supported.	Multithreaded RPC is not supported.

Function Compatibility Lists

The RPC library functions are listed in this section and grouped into functional areas. Each section includes lists of functions that are unchanged, have added functionality, and are new relative to previous releases.

Note - Functions marked with an asterisk are retained for ease of porting and may be not be supported in future releases of Solaris.

Creating Client Handles

The following functions are unchanged from the previous release and available in the current SunOS release:

```
clnt_destroy
clnt_pcreateerror
*clntraw_create
clnt_spcreateerror
*clnttcp_create
*clntudp_bufcreate
*clntudp_create
clnt_control
clnt_create
clnt_create_timed
clnt_create_vers
clnt_dg_create
clnt_raw_create
clnt_tli_create
clnt_tp_create
clnt_tp_create_timed
clnt_vc_create
```

Creating and Destroying Services

The following functions are unchanged from the previous releases and available in the current SunOS release:

```
svc_destroy
svcf_create
*svc_raw_create
*svc_tp_create
*svcudp_create
*svc_udp_bufcreate
svc_create
svc_dg_create
svc_fd_create
svc_raw_create
svc_tli_create
svc_tp_create
svc_vc_create
```

Registering and Unregistering Services

The following functions are unchanged from the previous releases and available in the current SunOS release:

```
*registerrpc
*svc_register
*svc_unregister
xprt_register
xprt_unregister
rpc_reg
svc_reg
svc_unreg
```

SunOS 4.x Compatibility Calls

The following functions are unchanged from previous releases and available in the current SunOS release:

```
*callrpc
clnt_call
*svc_getcaller - works only with IP-based transports
rpc_call
svc_getrpccaller
```

Broadcasting

The following call has the same functionality as in previous releases, although it is supported for backward compatibility only:

```
*clnt_broadcast
```

`clnt_broadcast ()` can broadcast only to the `portmap` service. It does not support `rpcbind`.

The following function that broadcasts to both `portmap` and `rpcbind` is also available in the current release of SunOS:

```
rpc_broadcast
```

Address Management Functions

The TI-RPC library functions interface with either `portmap` or `rpcbind`. Since the services of the programs differ, there are two sets of functions, one for each service.

The following functions work with `portmap`:

```
pmap_set
pmap_unset
pmap_getport
pmap_getmaps
pmap_rmtcall
```

The following functions work with `rpcbind`:

```
rpcb_set
rpcb_unset
rpcb_getaddr
rpcb_getmaps
rpcb_rmtcall
```

Authentication Functions

The following calls have the same functionality as in previous releases. They are supported for backward compatibility only:

```
authdes_create
authunix_create
authunix_create_default
authdes_seccreate
authsys_create
authsys_create_default
```

Other Functions

`rpcbind` provides a time service (primarily for use by secure RPC client-server time synchronization), available through the `rpcb_gettime()` function. `pmap_getport()` and `rpcb_getaddr()` can be used to get the port number of a registered service. `rpcb_getaddr()` communicates with any server running version 2, 3, or 4 of `rpcbind`. `pmap_getport()` can only communicate with version 2.

Comparison Examples

The changes in client creation from TS-RPC to TI-RPC are illustrated in Code Example 4-47 and Code Example 4-48. Each example

- Creates a UDP descriptor.
- Contacts the remote host's RPC binding process to get the services address.
- Binds the remote service's address to the descriptor.
- Creates the client handle and set its time out.

CODE EXAMPLE 4-47 Client Creation in TS-RPC

```
struct hostent *h;
struct sockaddr_in sin;
int sock = RPC_ANYSOCK;
u_short port;
struct timeval wait;

if ((h = gethostbyname( "host" )) == (struct hostent *) NULL)
{
    syslog(LOG_ERR, "gethostbyname failed");
    exit(1);
}
sin.sin_addr.s_addr = *(u_int *) hp->h_addr;
```

```

if ((port = pmap_getport(&sin, PROGRAM, VERSION, "udp")) == 0) {
    syslog (LOG_ERR, "pmap_getport failed");
    exit(1);
} else
    sin.sin_port = htons(port);
wait.tv_sec = 25;
wait.tv_usec = 0;
clntudp_create(&sin, PROGRAM, VERSION, wait, &sock);

```

The TI-RPC version assumes that the UDP transport has the netid *udp*. A netid is not necessarily a well-known name.

CODE EXAMPLE 4-48 Client Creation in TI-RPC

```

struct netconfig *nconf;
struct netconfig *getnetconfigent();
struct t_bind *tbind;
struct timeval wait;

nconf = getnetconfigent("udp");
if (nconf == (struct netconfig *) NULL) {
    syslog(LOG_ERR, "getnetconfigent for udp failed");
    exit(1);
}
fd = t_open(nconf->nc_device, O_RDWR, (struct t_info *)NULL);
if (fd == -1) {
    syslog(LOG_ERR, "t_open failed");
    exit(1);
}
tbind = (struct t_bind *) t_alloc(fd, T_BIND, T_ADDR);
if (tbind == (struct t_bind *) NULL) {
    syslog(LOG_ERR, "t_bind failed");
    exit(1);
}
if (rpcb_getaddr( PROGRAM, VERSION, nconf, &tbind->addr, "host")
    == FALSE) {
    syslog(LOG_ERR, "rpcb_getaddr failed");
    exit(1);
}
cl = clnt_tli_create(fd, nconf, &tbind->addr, PROGRAM, VERSION,
    0, 0);
(void) t_free((char *) tbind, T_BIND);
if (cl == (CLIENT *) NULL) {
    syslog(LOG_ERR, "clnt_tli_create failed");
    exit(1);
}
wait.tv_sec = 25;
wait.tv_usec = 0;
clnt_control(cl, CLSET_TIMEOUT, (char *) &wait);

```

Code Example 4-49 and Code Example 4-50 show the differences between broadcast in TS-RPC and TI-RPC. The older `clnt_broadcast()` is similar to the newer `rpc_broadcast()`. The primary difference is in the `collectnames()` function: deletes duplicate addresses and displays the names of hosts that reply to the broadcast.

CODE EXAMPLE 4-49 Broadcast in TS-RPC

```
statstime sw;
extern int collectnames();

clnt_broadcast(RSTATPROG, RSTATVERS_TIME, RSTATPROC_STATS,
              xdr_void, NULL, xdr_statstime, &sw, collectnames);
...
collectnames(resultsp, raddrp)
char *resultsp;
struct sockaddr_in *raddrp;
{
    u_int addr;
    struct entry *entryp, *lim;
    struct hostent *hp;
    extern int curentry;

    /* weed out duplicates */
    addr = raddrp->sin_addr.s_addr;
    lim = entry + curentry;
    for (entryp = entry; entryp < lim; entryp++)
        if (addr == entryp->addr)
            return (0);
    ...
    /* print the host's name (if possible) or address */
    hp = gethostbyaddr(&raddrp->sin_addr.s_addr, sizeof(u_int),
                     AF_INET);
    if ( hp == (struct hostent *) NULL)
        printf("0x%x", addr);
    else
        printf("%s", hp->h_name);
}
}
```

Code Example 4-50 shows the Broadcast for TI-RPC:

CODE EXAMPLE 4-50 Broadcast in TI-RPC

```
statstime sw;
extern int collectnames();

rpc_broadcast(RSTATPROG, RSTATVERS_TIME, RSTATPROC_STATS,
             xdr_void, NULL, xdr_statstime, &sw, collectnames, (char *)
0);
...

collectnames(resultsp, taddr, nconf)
char *resultsp;
struct t_bind *taddr;
struct netconfig *nconf;
{
    struct entry *entryp, *lim;
    struct nd_hostservlist *hs;
    extern int curentry;
    extern int netbufeq();

    /* weed out duplicates */
    lim = entry + curentry;
    for (entryp = entry; entryp < lim; entryp++)
```

```

    if (netbufeq( &taddr->addr, entry->addr))
        return (0);
    ...
    /* print the host's name (if possible) or address */
    if (netdir_getbyaddr( nconf, &hs, &taddr->addr ) == ND_OK)
        printf("%s", hs->h_hostservs->h_host);
    else {
        char *uaddr = taddr2uaddr(nconf, &taddr->addr);
        if (uaddr) {
            printf("%s\n", uaddr);
            (void) free(uaddr);
        } else
            printf("unknown");
    }
}
netbufeq(a, b)
struct netbuf *a, *b;
{
    return(a->len == b->len && !memcmp( a->buf, b->buf, a->len));
}

```

PART **III** NIS+

Part 3 discusses the NIS+ API.

- Chapter 5



NIS+ Programming Guide

This section presents the fundamental principles of the NIS+ applications programming interface and a detailed sample program. The NIS+ API is for programmers who need to build applications for Solaris-based networks. It provides the essential features for supporting enterprise-wide applications.

- “NIS+ Overview” on page 171
- “NIS+ API” on page 175
- “NIS+ Sample Program” on page 180

The NIS+ network name service addresses the requirements of client/server networks ranging in size from 10 clients supported by a few servers on a simple local area network to 10,000 multi-vendor clients supported by 20 to 100 specialized servers located in sites throughout the world and connected by several public networks.

NIS+ Overview

Domains

NIS+ supports hierarchical domains, illustrated as a simple case in Figure 5-1

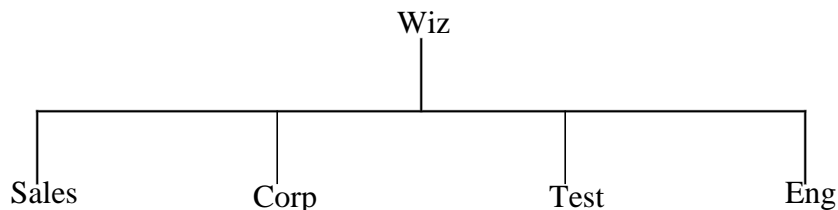

Figure 5-1 NIS+ Domain

A NIS+ domain is a set of data describing the workstations, users, and network services in a portion of an organization. NIS+ domains can be administered independently of each other. This allows NIS+ to be used in a range of networks, from small to very large.

Servers

Each domain is supported by a set of servers. The principal server is called the master server, and the backup servers are called replicas. Both master and replica servers run NIS+ server software. The master server stores the original tables, and the backup servers store copies.

NIS+ accepts incremental updates to the replicas. Changes are first made on the master server. Then they are automatically propagated to the replica servers and are soon available to the entire namespace.

Tables

NIS+ stores information in tables instead of maps or zone files. NIS+ provides 16 types of predefined, or system, tables, shown in Figure 5-2.

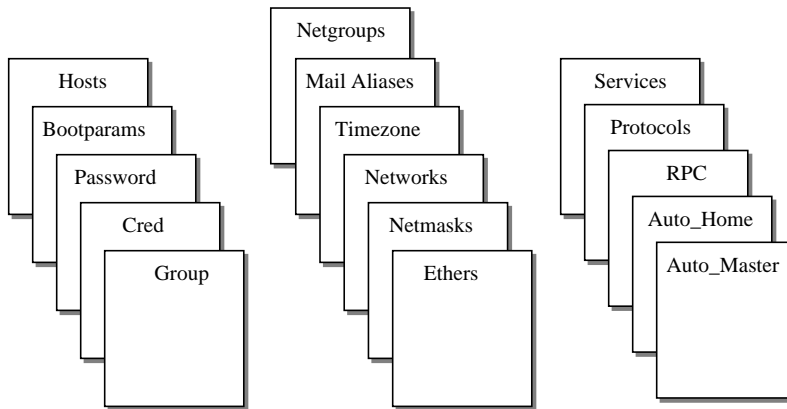

Figure 5-2 NIS+ Tables

Each table stores a different type of information. For instance, the Hosts table stores host name/Internet address pairs, and the Password table stores information about users of the network.

NIS+ tables have two major improvements over NIS maps. First, a NIS+ table can be accessed by any column, not just the first column (sometimes referred to as the “key”). This eliminates the need for duplicate maps, such as the `hosts.byname` and `hosts.byaddr` maps of NIS. Second, access to the information in NIS+ tables can

be controlled at three levels of granularity: the table level, the entry level, and the column level.

NIS+ Security

The NIS+ security model provides both authorization and authentication mechanisms. First, every object in the namespace specifies the type of operation it accepts and from whom. This is authorization. Second, NIS+ attempts to authenticate every requestor accessing the namespace. Once it identifies the originator of the request, it determines whether the object has authorized that particular operation for that particular principal. Based on its authentication and the object's authorization, NIS+ carries out or denies the access request.

Name Service Switch

NIS+ works in conjunction with a separate facility called the Name Service Switch. The Name Service Switch, sometimes referred to as “the Switch,” lets Solaris 2.x-based workstations obtain their information from more than one network information service; specifically, from local, or `/etc` files, from NIS maps, from DNS zone files, or from NIS+ tables. The Switch not only offers a choice of sources, but allows a workstation to specify different sources for different *types* of information. The name service is configured through the file `/etc/nsswitch.conf`.

NIS+ Administration Commands

NIS+ provides a full set of commands for administering a namespace.

Table 5-1 summarizes them.

TABLE 5-1 NIS+ Namespace Administration Commands

Command	Description
<code>nischgrp</code>	Changes the group owner of a NIS+ object.
<code>nischmod</code>	Changes an object's access rights.
<code>nischown</code>	Changes the owner of a NIS+ object.

TABLE 5-1 NIS+ Namespace Administration Commands *(continued)*

Command	Description
<code>nisgrpadm</code>	Creates or destroys a NIS+ group, or displays a list of its members. Also adds members to a group, removes them, or tests them for membership in the group.
<code>niscat</code>	Displays the contents of NIS+ tables.
<code>nisgrep</code>	Searches for entries in a NIS+ table.
<code>nisls</code>	Lists the contents of a NIS+ directory.
<code>nismatch</code>	Searches for entries in a NIS+ table.
<code>nisaddent</code>	Adds information from <code>/etc</code> files or NIS maps into NIS+ tables.
<code>nistbladm</code>	Creates or deletes NIS+ tables, and adds, modifies or deletes entries in a NIS+ table.
<code>nisaddcred</code>	Creates credentials for NIS+ principals and stores them in the Cred table.
<code>nispasswd</code>	Changes password information stored in the NIS+ Passwd table.
<code>nisupdkeys</code>	Updates the public keys stored in a NIS+ object.
<code>nisinit</code>	Initializes a NIS+ client or server.
<code>nismkdir</code>	Creates a NIS+ directory and specifies its master and replica servers.
<code>nismkdir</code>	Removes NIS+ directories and replicas from the namespace.
<code>nissetup</code>	Creates <code>org_dir</code> and <code>groups_dir</code> directories and a complete set of (unpopulated) NIS+ tables for a NIS+ domain.
<code>rpc.nisd</code>	The NIS+ server process.
<code>nis_cachemgr</code>	Starts the NIS+ Cache Manager on a NIS+ client.
<code>nischttl</code>	Changes a NIS+ object's time-to-live value.
<code>nisdefaults</code>	Lists a NIS+ object's default values: domain name, group name, workstation name, NIS+ principal name, access rights, directory search path, and time-to-live.

TABLE 5-1 NIS+ Namespace Administration Commands *(continued)*

Command	Description
<code>nisl</code>	Creates a symbolic link between two NIS+ objects.
<code>nism</code>	Removes NIS+ objects (except directories) from the namespace.
<code>niss</code>	Lists the contents of the NIS+ shared cache maintained by the NIS+ Cache Manager.

NIS+ API

The NIS+ application programming interface (API) is a group of functions that can be called by an application to access and modify NIS+ objects. The NIS+ API has 54 functions that fall into nine categories:

- Object Manipulation Functions (`nis_names`)
- Table Access Functions (`nis_tables`)
- Local Name Functions (`nis_local_names`)
- Group Manipulation Functions (`nis_groups`)
- Server Related Functions (`nis_server`)
- Database Access Functions (`nis_db`)
- Error Message Display Functions (`nis_error`)
- Transaction Log Functions (`nis_admin`)
- Miscellaneous Functions (`nis_subr`)

The functions in each category are summarized in Table 5-2. The category names match the names by which they are grouped in the NIS+ manpages.

TABLE 5-2 NIS+ API Functions

Function	Description
<code>nis_names()</code>	Locate and Manipulate Objects
<code>nis_lookup()</code>	Returns a copy of an NIS+ object. Can follow links. Though it cannot search for an entry object, if a link points to one, it can return an entry object.
<code>nis_add()</code>	Adds an NIS+ object to the namespace.
<code>nis_remove()</code>	Removes an NIS+ object in the namespace.
<code>nis_modify()</code>	Modifies an NIS+ object in the namespace.
<code>nis_tables</code>	Search and Update Tables.
<code>nis_list()</code>	Searches a table in the NIS+ namespace and returns entry objects that match the search criteria. Can follow links and search paths from one table to another.
<code>nis_add_entry()</code>	Adds an entry object to an NIS+ table. Can be instructed to either fail or overwrite if the entry object already exists. Can return a copy of the resulting object if the operation was successful.
<code>nis_freeresult()</code>	Frees all memory associated with a <code>nis_result</code> structure.
<code>nis_remove_entry()</code>	Removes one or more entry objects from an NIS+ table. Can identify the object to be removed by using search criteria or by pointing to a cached copy of the object. If using search criteria, can remove all objects that match the search criteria; therefore, with the proper search criteria, can remove all entries in a table. Can return a copy of the resulting object if the operation was successful.
<code>nis_modify_entry()</code>	Modifies one or more entry objects in an NIS+ table. Can identify the object to be modified by using search criteria or by pointing to a cached copy of the object.
<code>nis_first_entry()</code>	Returns a copy of the first entry object in an NIS+ table.

TABLE 5-2 NIS+ API Functions *(continued)*

Function	Description
<code>nis_next_entry()</code>	Returns a copy of the “next” entry object in an NIS+ table. Because a table can be updated and entries removed or modified between calls to this function, the order of entries returned may not match the actual order of entries in the table.
<code>nis_local_names()</code>	Get Default Names for the Current Process
<code>nis_local_directory()</code>	Returns the name of the workstation’s NIS+ domain.
<code>nis_local_host()</code>	Returns the fully-qualified name of the workstation. A fully qualified name has the form <host-name>.<domain-name>.
<code>nis_local_group()</code>	Returns the name of the current NIS+ group, which is specified by the environment variable NIS_GROUP.
<code>nis_local_principal()</code>	Returns the name of the NIS+ principal whose UID is associated with the calling process.
<code>nis_getnames()</code>	Returns a list of possible expansions to a particular name.
<code>nis_freenames()</code>	Frees the memory containing the list generated by <code>nis_getnames()</code> .
<code>nis_groups()</code>	Group Manipulation and Authorization
<code>nis_ismember()</code>	Test whether a principal is a member of a group.
<code>nis_addmember()</code>	Adds a member to a group. The member can be a principal, a group, or a domain.
<code>nis_removemember()</code>	Deletes a member from a group.
<code>nis_creategroup()</code>	Create a group object.
<code>nis_destroygroup()</code>	Delete a group object.
<code>nis_verifygroup()</code>	Tests whether a group object exists.
<code>nis_print_group_entry()</code>	Lists the principals that are members of a group object.

TABLE 5-2 NIS+ API Functions *(continued)*

Function	Description
<code>nis_server</code>	Various services for NIS+ applications.
<code>nis_mkdir()</code>	Creates the databases to support service for a named directory on a specified host.
<code>nis_rmdir()</code>	Removes the directory from a host.
<code>nis_servstate()</code>	Sets and reads state variables of NIS+ servers and flushes internal caches.
<code>nis_stats()</code>	Retrieves statistics about a server's performance.
<code>nis_getservlist()</code>	Returns a list of servers that support a particular domain.
<code>nis_freeservlist()</code>	Frees the list of servers returned by <code>nis_getservlist()</code> .
<code>nis_freetags()</code>	Frees the memory associated with the results of <code>nis_servstate()</code> and <code>nis_stats()</code> .
<code>nis_db</code>	Interface Between the NIS+ Server and the Database. Not To Be Used By a NIS+ Client.
<code>db_first_entry()</code>	Returns a copy of the first entry of the specified table.
<code>db_next_entry()</code>	Returns a copy of the entry succeeding the specified entry.
<code>db_reset_next_entry()</code>	Terminates a first/next entry sequence.
<code>db_list_entries()</code>	Returns copies of entries that meet specified attributes.
<code>db_remove_entry()</code>	Removes all entries that meet specified attributes.
<code>db_add_entry()</code>	Replaces an entry in a table identified by specified attributes with a copy of the specified object, or adds the object to the table.
<code>db_checkpoint()</code>	Reorganizes the contents of a table to make access to the table more efficient.
<code>db_standby()</code>	Advises the database manager to release resources.

TABLE 5-2 NIS+ API Functions *(continued)*

Function	Description
<code>nis_error()</code>	Functions that supply descriptive strings equivalent to NIS+ status values
<code>nis_sperrno()</code>	Returns a pointer to the appropriate string constant.
<code>nis_perror()</code>	Displays the appropriate string constant on standard output.
<code>nis_lerror()</code>	Sends the appropriate string constant to syslog
<code>nis_sperror()</code>	Returns a pointer to a statically allocated string to be used or to be copied with <code>strdup()</code> .
<code>nis_admin</code>	Transaction logging functions used by servers
<code>nis_ping</code>	Used by the master server of a directory to time stamp it. This forces replicas of the directory to be updated.
<code>nis_checkpoint()</code>	Forces logged data to be stored in the table on disk.
<code>nis_subr</code>	Functions To Help Operate on NIS+ Names and Objects.
<code>nis_leaf_of()</code>	Returns the first label in an NIS+ name. The returned name does not have a trailing dot.
<code>nis_name_of()</code>	Removes all domain-related labels and returns only the unique object portion of the name. The name passed to the function must be either in the local domain or in one of its child domains, or the function returns NULL.
<code>nis_domain_of()</code>	Returns the name of the domain in which an object resides. The returned name ends in a dot.
<code>nis_dir_cmp()</code>	Compares any two NIS+ names. The comparison ignores case and states whether the names are the same, descendants of each other, or not related.
<code>nis_clone_object()</code>	Creates an exact duplicate of an NIS+ object.

TABLE 5-2 NIS+ API Functions (continued)

Function	Description
<code>nis_destroy_object()</code>	Destroys an object created by <code>nis_clone_object()</code> .
<code>nis_print_object()</code>	Prints the contents of an NIS+ object structure to <code>stdout</code> .

NIS+ Sample Program

This program performs the following tasks:

- Determines the local principal and local domain
- Looks up the local directory object
- Creates a directory called `foo` under the local domain
- Creates the `groups_dir` and `org_dir` directories under domain `foo`
- Creates a group object `admins.foo`
- Adds the local principal to the `admins` group
- Creates a table under `org_dir.foo`
- Adds two entries to the `org_dir.foo` table
- Retrieves and displays the new membership list of the `admins` group
- Lists the namespace under the `foo` domain using callbacks
- Lists the contents of the table created using callbacks
- Cleans up all the objects that were created by removing the following:
 - the local principal from the `admins` group
 - the `admins` group
 - the entries in the table followed by the table
 - the `groups_dir` and `org_dir` directory objects
 - the `foo` directory object

The example program is not a typical application. In a normal situation the directories and tables would be created or removed through the command line interface, and applications would manipulate NIS+ entry objects.

Unsupported Macros

The sample program uses unsupported macros that are defined in the file `<rpcsvc/nis.h>`. These are not public APIs and can change or disappear in the future. They are used for illustration purposes only and if you choose to use them, you do so at your own risk. The macros used are:

- `NIS_RES_OBJECT`
- `ENTRY_VAL`
- `DEFAULT_RIGHTS`

Functions Used in the Example

The use of the following NIS+ C API functions is illustrated through this example:

```
nis_add() nis_add_entry() nis_addmember()
nis_creategroup() nis_destroygroup() nis_domain_of()
nis_freeresult() nis_leaf_of() nis_list()
nis_local_directory() nis_local_principal() nis_lookup()
nis_mkdir() nis_perror() nis_remove()
nis_remove_entry() nis_removemember()
```

Program Compilation

The program shown in Code Example 5-1 assumes that the NIS+ principal running this application has permission to create directory objects in the local domain. The program is compiled:

```
yourhost% cc -o example.c example -lnsl
```

It is invoked:

```
yourhost% example [dir]
```

where `dir` is the NIS+ directory in which the program creates all the NIS+ objects. Specifying no directory argument causes the objects to be created in the parent directory of the local domain. Note that for the call to `nis_lookup()`, a space and the name of the local domain are appended to the string that names the directory. The argument is the name of the NIS+ directory in which to create the NIS+ objects. The principal running this program should have create permission in the directory.

CODE EXAMPLE 5-1 NIS+ Program Main example.c

```
#include <stdio.h>
#include <string.h>
#include <stdlib.h>
#include <rpcsvc/nis.h>

#define MAX_MSG_SIZE 512
#define BUFFER_SIZE 64
#define TABLE_TYPE "test_data"

main(argc, argv)
int argc;
char *argv[];
{
    char *saved_grp, *saved_name, *saved_owner;
    char dir_name[NIS_MAXNAMELEN];
    char local_domain[NIS_MAXNAMELEN];
    char local_princip [NIS_MAXNAMELEN];
    char org_dir_name [NIS_MAXNAMELEN];
    char grp_name [NIS_MAXNAMELEN];
    char grp_dir_name [NIS_MAXNAMELEN];
    char table_name [NIS_MAXNAMELEN];
    nis_object *diobj, entdata;
    nis_result *pres;
    u_int saved_num_servers;
    int err;

    if (argc == 2)
        sprintf (local_domain, "%s.", argv[1]);
    else
        strcpy (local_domain, "");

    strcat (local_domain, (char *) nis_local_directory());

    strcpy (local_princip, (char *) nis_local_principal());

    /*
     * Lookup the directory object for the local domain for two
     reasons:
     * 1.To get a template of a nis_object.
     * 2.To reuse some of the information contained in the
     directory
     * object returned. We could have declared a static
     nis_object, but
     * since we need to change very little, it is easier to make
     the
     * changes and not initialize the nis_object structure.
     */

    pres = nis_lookup (local_domain, 0);
    if (pres->status != NIS_SUCCESS) {
        nis_perror (pres->status, "unable to lookup local
        directory");
        exit (1);
    }
}
```

(continued)

(Continuation)

```
/*
 * re-use most of the fields in the parent directory object -
save
 * pointers to the fields that are being changed so that we can
 * free the original object and avoid dangling pointer
references.
 */
dirobj = NIS_RES_OBJECT (pres);
saved_name = dirobj->DI_data.do_name;
saved_owner = dirobj->zo_owner;
saved_grp = dirobj->zo_group;

/*
 * set the new name, group, owner and new access rights for the
 * foo domain.
 */
sprintf (dir_name, "%s.%s", "foo", local_domain);
sprintf (grp_name, "%s.%s", "admins", dir_name);
dirobj->DI_data.do_name = dir_name;
dirobj->zo_group = grp_name;
dirobj->zo_owner = local_princip;

/*
 * Access rights in NIS+ are stored in a u_long with the
highest
 * order bytes reserved for the "nobody" category, the next
eight
 * bytes reserved for the owner, followed by group and world.
In
 * this example we are giving access to the directory based
on the
 * "----rmdrmd----" access right pattern.
 */
dirobj->zo_access = ((NIS_READ_ACC + NIS_MODIFY_ACC
+ NIS_CREATE_ACC + NIS_DESTROY_ACC) << 16)
| ((NIS_READ_ACC + NIS_MODIFY_ACC
+ NIS_CREATE_ACC + NIS_DESTROY_ACC) << 8);

/*
 * Save the number of servers the parent directory object had
so
 * that we can restore this value before calling
nis_freeresult()
 * later and avoid memory leaks.
 */
saved_num_servers = dirobj-
>DI_data.do_servers.do_servers_len;

/* We want only one server to serve this directory */
dirobj->DI_data.do_servers.do_servers_len = 1;

dir_create (dir_name, dirobj);
```

(continued)

(Continuation)

```
/* create the groups_dir and org_dir directories under foo. */
sprintf (grp_dir_name, "groups_dir.%s", dir_name);
dirobj->DI_data.do_name = grp_dir_name;
dir_create (grp_dir_name, dirobj);

sprintf (org_dir_name, "org_dir.%s", dir_name);
dirobj->DI_data.do_name = org_dir_name;
dir_create (org_dir_name, dirobj);

grp_create (grp_name);

printf ("\nAdding principal %s to group %s ... \n",
        local_princip, grp_name);
err = nis_addmember (local_princip, grp_name);

if (err != NIS_SUCCESS) {
    nis_perror (err,
               "unable to add local principal to group.");
    exit (1);
}

sprintf (table_name, "test_table.org_dir.%s", dir_name);
tbl_create (dirobj, table_name);

/*
 * Now create NIS+ entry objects in the table that was just
 * created
 */
stuff_table (table_name);

/* Display what we stuffed */
list_objs(dir_name, table_name, grp_name);

/* Clean out everything we created. */
cleanup (local_princip, grp_name, table_name, dir_name,
        dirobj);

/*
 * Restore the saved pointers from the original pres structure
 * so that we can free up the associated memory and have no
 * memory leaks.
 */
dirobj->DI_data.do_name = saved_name;
dirobj->zo_group = saved_grp;
dirobj->zo_owner = saved_owner;
dirobj->DI_data.do_servers.do_servers_len =
saved_num_servers;
(void) nis_freeresult (pres);
}
```

Code Example 5-2 shows the routine is called by `main()` to create directory objects.

CODE EXAMPLE 5-2 NIS+ Routine to Create Directory Objects

```
void
dir_create (dir_name, dirobj)
    nis_name  dir_name;
    nis_object *dirobj;
{
    nis_result *cres;
    nis_error  err;

    printf ("\n Adding Directory %s to namespace ... \n",
dir_name);
    cres = nis_add (dir_name, dirobj);

    if (cres->status != NIS_SUCCESS) {
        nis_perror (cres->status, "unable to add directory foo.");
        exit (1);
    }

    (void) nis_freeresult (cres);

    /*
     * NOTE: you need to do a nis_mkdir to create the table to
     store the
     * contents of the directory you are creating.
     */
    err = nis_mkdir (dir_name,

        dirobj->DI_data.do_servers.do_servers_val);
    if (err != NIS_SUCCESS) {
        (void) nis_remove (dir_name, 0);

        nis_perror (err,
            "unable to create table for directory object foo.");
        exit (1);
    }
}
```

This routine is called by `main()` to create the group object. Since `nis_creategroup()` works only on group objects, the “groups_dir” literal is not needed in the group name.

CODE EXAMPLE 5-3 NIS+ Routine to Create Group Objects

```
void
grp_create (grp_name)
    nis_name  grp_name;
{
    nis_error  err;

    printf ("\n Adding %s group to namespace ... \n", grp_name);
    err = nis_creategroup (grp_name, 0);
    if (err != NIS_SUCCESS) {
        nis_perror (err, "unable to create group.");
        exit (1);
    }
}
```

The routine shown in Code Example 5-3 is called by `main()` to create a table object laid out as shown in Table 5-3.

TABLE 5-3 NIS+ Table Objects

	Column1	Column2
Name:	id	name
Attributes:	Searchable, Text	Searchable, Text
Access Rights	—rmcdr—r—	—rmcdr—r—

The `TA_SEARCHABLE` constant indicates to the service that the column is searchable. Only `TEXT` (the default) columns are searchable. `TA_CASE` indicates to the service that the column value is to be treated in a case-insensitive manner during searches.

CODE EXAMPLE 5-4 NIS+ Routine to Create Table Objects

```
#define TABLE_MAXCOLS 2
#define TABLE_COLSEP ':'
#define TABLE_PATH 0

void
tbl_create (diobj, table_name)
    nis_object *diobj; /* need to use some of the fields */
    nis_name table_name;
{
    nis_result *cres;
    static nis_object tblobj;
    static table_col tbl_cols[TABLE_MAXCOLS] = {
        {"Id", TA_SEARCHABLE | TA_CASE, DEFAULT_RIGHTS},
        {"Name", TA_SEARCHABLE | TA_CASE, DEFAULT_RIGHTS}
    };

    tblobj.zo_owner = diobj->zo_owner;
    tblobj.zo_group = diobj->zo_group;
    tblobj.zo_access = DEFAULT_RIGHTS; /* macro defined in
nis.h */
    tblobj.zo_data.zo_type = TABLE_OBJ; /* enumerated type in
nis.h */
    tblobj.TA_data.ta_type = TABLE_TYPE;
    tblobj.TA_data.ta_maxcol = TABLE_MAXCOLS;
    tblobj.TA_data.ta_sep = TABLE_COLSEP;
    tblobj.TA_data.ta_path = TABLE_PATH;
    tblobj.TA_data.ta_cols.ta_cols_len =
        tblobj.TA_data.ta_maxcol; /* ALWAYS ! */
    tblobj.TA_data.ta_cols.ta_cols_val = tbl_cols;

    /*
     * Use a fully qualified table name i.e. the "org_dir" literal
     should
```

```

    * be embedded in the table name. This is necessary because
nis_add
    * operates on all types of NIS+ objects and needs the full path
name
    * if a table is created.
    */
printf ("\n Creating table %s ... \n", table_name);
cres = nis_add (table_name, &tblobj);
if (cres->status != NIS_SUCCESS) {
    nis_perror (cres->status, "unable to add table.");
    exit (1);
}
(void) nis_freeresult (cres);
}

```

The routine shown in Code Example 5-5 is called by main() to add entry objects to the table object. Two entries are added to the table object. Note that the column width in both entries is set to include the NULL character for a string terminator.

CODE EXAMPLE 5-5 NIS+ Routine to Add Objects to Table

```

#define    MAXENTRIES 2
void
stuff_table(table_name)
    nis_name    table_name;
{
    int    i;
    nis_object    entdata;
    nis_result    *cres;
    static entry_col ent_col_data[MAXENTRIES][TABLE_MAXCOLS] = {
        {0, 2, "1", 0, 5, "John"},
        {0, 2, "2", 0, 5, "Mary"}
    };

    printf ("\n Adding entries to table ... \n");

    /*
     * Look up the table object first since the entries being added
     * should have the same owner, group owner and access rights as
     * the table they go in.
     */
    cres = nis_lookup (table_name, 0);

    if (cres->status != NIS_SUCCESS) {
        nis_perror (cres->status, "Unable to lookup table");
        exit(1);
    }
    entdata.zo_owner = NIS_RES_OBJECT (cres)->zo_owner;
    entdata.zo_group = NIS_RES_OBJECT (cres)->zo_group;
    entdata.zo_access = NIS_RES_OBJECT (cres)->zo_access;

    /* Free cres, so that it can be reused. */
    (void) nis_freeresult (cres);

    entdata.zo_data.zo_type = ENTRY_OBJ; /* enumerated type in
nis.h */
    entdata.EN_data.en_type = TABLE_TYPE;

```

```

entdata.EN_data.en_cols.en_cols_len = TABLE_MAXCOLS;
for (i = 0; i < MAXENTRIES; ++i) {
    entdata.EN_data.en_cols.en_cols_val = &ent_col_data[i][0];
    cres = nis_add_entry (table_name, &entdata, 0);

    if (cres->status != NIS_SUCCESS) {
        nis_perror (cres->status, "unable to add entry.");
        exit (1);
    }
    (void) nis_freeresult (cres);
}
}
}

```

The routine shown in Code Example 5-6 is the print function for the `nis_list()` call. When `list_objs()` calls `nis_list()`, a pointer to `print_info()` is one of the calling arguments. Each time the service calls this function, it prints the contents of the entry object. The return value indicates to the library to call with the next entry from the table.

CODE EXAMPLE 5-6 NIS+ Routine for `nis_list` Call

```

int
print_info (name, entry, cbdata)
    nis_name    name; /* Unused */
    nis_object  *entry; /* The NIS+ entry object */
    void        *cbdata; /* Unused */
{
    static u_int    firsttime = 1;
    entry_col      *tmp; /* only to make source more readable */
    u_int          i, terminal;

    if (firsttime) {
        printf ("\tId.\t\t\tName\n");
        printf ("\t---\t\t\t---\n");
        firsttime = 0;
    }
    for (i = 0; i < entry->EN_data.en_cols.en_cols_len; ++i) {
        tmp = &entry->EN_data.en_cols.en_cols_val[i];
        terminal = tmp->ec_value.ec_value_len;
        tmp->ec_value.ec_value_val[terminal] = '\0';
    }

    /*
     * ENTRY_VAL is a macro that returns the value of a specific
     * column value of a specified entry.
     */
    printf ("\t%s\t\t\t%s\n", ENTRY_VAL (entry, 0),
            ENTRY_VAL (entry, 1));
    return (0); /* always ask for more */
}

```

The routine shown in Code Example 5-7 is called by `main()` to list the contents of the group, table and directory objects. The routine demonstrates the use of callbacks also. It retrieves and displays the membership of the group. The group membership

list is not stored as the contents of the object. So, it is queried through the `nis_lookup()` instead of the `nis_list()` call. You must use the “groups_dir” form of the group name since `nis_lookup()` works on all types of NIS+ objects.

CODE EXAMPLE 5-7 NIS+ Routine to List Objects

```

void
list_objs(dir_name, table_name, grp_name)
    nis_name  dir_name, table_name, grp_name;
{
    group_obj  *tmp; /* only to make source more readable */
    u_int      i;
    char      grp_obj_name [NIS_MAXNAMELEN];
    nis_result *cres;
    char      index_name [BUFFER_SIZE];

    sprintf (grp_obj_name, "%s.groups_dir.%s",
            nis_leaf_of (grp_name), nis_domain_of (grp_name));
    printf ("\nGroup %s membership is: \n", grp_name);

    cres = nis_lookup(grp_obj_name, 0);

    if (cres->status != NIS_SUCCESS) {
        nis_perror (cres->status, "Unable to lookup group object.");
        exit(1);
    }

    tmp = &(NIS_RES_OBJECT(cres)->GR_data);
    for (i = 0; i < tmp->gr_members.gr_members_len; ++i)
        printf ("\t %s\n", tmp->gr_members.gr_members_val[i]);
    (void) nis_freeresult (cres);

    /*
     * Display the contents of the foo domain without using
     * callbacks.
     */
    printf ("\nContents of Directory %s are: \n", dir_name);
    cres = nis_list (dir_name, 0, 0, 0);
    if (cres->status != NIS_SUCCESS) {
        nis_perror (cres->status,
                    "Unable to list Contents of
Directory foo.");
        exit(1);
    }
    for (i = 0; i < NIS_RES_NUMOBJ(cres); ++i)
        printf ("\t%s\n", NIS_RES_OBJECT(cres)[i].zo_name);
    (void) nis_freeresult (cres);

    /*
     * List the contents of the table we created using the callback
     * form
     * of nis_list().
     */
    printf ("\n Contents of Table %s are: \n", table_name);
    cres = nis_list (table_name, 0, print_info, 0);
    if(cres->status != NIS_CBRESULTS && cres->status !=
NIS_NOTFOUND){
        nis_perror (cres->status,

```

```

        "Listing entries using callback failed");
    exit(1);
}
(void) nis_freeresult (cres);

/*

 * List only one entry from the table we created. We will
 * use indexed names to do this retrieval.
 */

printf("\n Entry corresponding to id 1 is:\n");
/*
 * The name of the column is usually extracted from the table
 * object, which would have to be retrieved first.
 */
sprintf(index_name, "[Id=1],%s", table_name);
cres = nis_list (index_name, 0, print_info, 0);
if(cres->status != NIS_CBRESULTS && cres->status !=
NIS_NOTFOUND){
    nis_perror (cres->status,
        "Listing entry using indexed names and callback failed");
    exit(1);
}
(void) nis_freeresult (cres);
}

```

The routine in Code Example 5-8 is called by `cleanup()` to remove a directory object from the namespace. It also informs the servers serving the directory about this deletion. Notice that the memory containing result structure, pointed to by `cres`, must be freed after the result has been tested.

CODE EXAMPLE 5-8 NIS+ Routine to Remove Directory Objects

```

void
dir_remove(dir_name, srv_list, numservers)
    nis_name  dir_name;
    nis_server *srv_list;
    u_int    numservers;
{
    nis_result *cres;
    nis_error  err;
    u_int     i;

    printf ("\nRemoving %s directory object from namespace ...
\n",
        dir_name);
    cres = nis_remove (dir_name, 0);
    if (cres->status != NIS_SUCCESS) {
        nis_perror (cres->status, "unable to remove directory");
        exit (1);
    }
    (void) nis_freeresult (cres);

    for (i = 0; i < numservers; ++i) {
        err = nis_rmdir (dir_name, &srv_list[i]);
        if (err != NIS_SUCCESS) {

```

```

        nis_perror (err,
        "unable to remove server from directory");
        exit (1);
    }
}
}

```

This routine, Code Example 5-9, is called by `main()` to delete all the objects that were created in this example. Note the use of the `REM_MULTIPLE` flag in the call to `nis_remove_entry()`. All entries must be deleted from a table before the table itself can be deleted.

CODE EXAMPLE 5-9 NIS+ Routine to Remove All Objects

```

void
cleanup(local_princip, grp_name, table_name, dir_name, dirobj)
    nis_name local_princip, grp_name, table_name, dir_name;
    nis_object *dirobj;
{
    char grp_dir_name [NIS_MAXNAMELEN];
    char org_dir_name [NIS_MAXNAMELEN];
    nis_error err;
    nis_result *cres;

    sprintf(grp_dir_name, "%s.%s", "groups_dir", dir_name);
    sprintf(org_dir_name, "%s.%s", "org_dir", dir_name);

    printf("\n\nStarting to Clean up ... \n");
    printf("\n\nRemoving principal %s from group %s \n",
        local_princip, grp_name);
    err = nis_removemember (local_princip, grp_name);

    if (err != NIS_SUCCESS) {
        nis_perror (err,
        "unable to delete local principal from group.");
        exit (1);
    }

    /*
     * Delete the admins group. We do not use the "groups_dir" form
     * of the group name since this API is applicable to groups
     only.
     * It automatically embeds the groups_dir literal in the name
     of
     * the group.
     */
    printf("\n\nRemoving %s group from namespace ... \n",
    grp_name);
    err = nis_destroygroup (grp_name);
    if (err != NIS_SUCCESS) {
        nis_perror (err, "unable to delete group.");
        exit (1);
    }

    printf("\n\nDeleting all entries from table %s ... \n",

```

```

table_name);

cres = nis_remove_entry(table_name, 0, REM_MULTIPLE);
switch (cres->status) {
  case NIS_SUCCESS:
  case NIS_NOTFOUND:
    break;
  default:
    nis_perror(cres->status, "Could not delete entries from
        table");
    exit(1);
}
(void) nis_freeresult (cres);

printf("\n Deleting table %s itself ... \n", table_name);
cres = nis_remove(table_name, 0);

if (cres->status != NIS_SUCCESS) {
  nis_perror(cres->status, "Could not delete table.");
  exit(1);
}
(void) nis_freeresult (cres);

/* delete the groups_dir, org_dir and foo directory objects.
*/

dir_remove (grp_dir_name,
            dirobj->DI_data.do_servers.do_servers_val,
            dirobj->DI_data.do_servers.do_servers_len);
dir_remove (org_dir_name,
            dirobj->DI_data.do_servers.do_servers_val,
            dirobj->DI_data.do_servers.do_servers_len);
dir_remove (dir_name, dirobj-
>DI_data.do_servers.do_servers_val,
            dirobj->DI_data.do_servers.do_servers_len);
}

```

Running the program displays on the screen, as shown in Figure 5-3.

```

myhost% domainname
sun.com
myhost% ./sample
Adding Directory foo.sun.com. to namespace ...
Adding Directory groups_dir.foo.sun.com. to namespace ...
Adding Directory org_dir.foo.sun.com. to namespace ...
Adding admins.foo.sun.com. group to namespace ...
Adding principal myhost.sun.com. to group admins.foo.sun.com. ...
Creating table test_table.org_dir.foo.sun.com. ...
Adding entries to table ...
Group admins.foo.sun.com. membership is:
    myhost.sun.com.
Contents of Directory foo.sun.com. are:
    groups_dir
    org_dir

Contents of Table test_table.org_dir.foo.sun.com. are:
    Id.                Name
    ---                ----

```



```

1                               John
2                               Mary

Entry corresponding to id 1 is:
1                               John

Starting to Clean up ...

Removing principal myhost.sun.com. from group admins.foo.sun.com.
Removing admins.foo.sun.com. group from namespace ...
Deleting all entries from table test_table.org_dir.foo.sun.com. ...
Deleting table test_table.org_dir.foo.sun.com. itself ...
Removing groups_dir.foo.sun.com. directory object from namespace ...
Removing org_dir.foo.sun.com. directory object from namespace ...
Removing foo.sun.com. directory object from namespace ...
myhost%

```

Figure 5-3 NIS+ Program Execution

As a debugging aid, the same operations are performed by the following command sequence. The first command:

```
% niscat -o 'domainname'
```

displays the name of the master server. Substitute the master server name where the variable *master* appears below.

```

% nismkdir -m master foo.'domainname'.

# Create the org_dir.foo subdirectory with the specified master
% nismkdir -m master org_dir.foo.'domainname'.
# Create the groups_dir.foo subdirectory with the specified master
% nismkdir -m master groups_dir.foo.'domainname'.
# Create the 'admins' group
% nisgrpadm -c admins.foo.'domainname'.

# Add yourself as a member of this group
% nisgrpadm -a admins.foo.'domainname'. 'nisdefaults -p'

# Create a test_table with two columns : Id and Name
% nistbladm -c test_data id=SI Name=SI \
test_table.org_dir.foo.'domainname'

# Add one entry to that table.
% nistbladm -a id=1 Name=John test_table.org_dir.foo.'domainname'.
# Add another entry to that table.
% nistbladm -a id=2 Name=Mary test_table.org_dir.foo.'domainname'.

# List the members of the group admins
% nisgrpadm -l admins.foo.'domainname'.
# List the contents of the foo directory
% nisls foo.'domainname'.
# List the contents of the test_table along with its header
% niscat -h test_table.org_dir.foo.'domainname'.

# Get the entry from the test_table where id = 1
% nismatch id=1 test_table.org_dir.foo.'domainname'.

# Delete all we created.

```

```
# First, delete yourself from the admins group
% nisgrpadm -r admins.foo.'domainname'. 'nisdefaults -p'
# Delete the admins group
% nisgrpadm -d admins.foo.'domainname'.
# Delete all the entries from the test_table
% nistbladm -r '['',test_table.org_dir.foo.'domainname'.''
# Delete the test_table itself.
% nistbladm -d test_table.org_dir.foo.'domainname'.
# Delete all three directories that we created
% nisrmdir groups_dir.foo.'domainname'.
% nisrmdir org_dir.foo.'domainname'.
% nisrmdir foo.'domainname'.
```

XDR Technical Note

This appendix is a technical note on Sun Microsystems's implementation of the external data representation (XDR) standard, which is a set of library routines that enable C programmers to describe arbitrary data structures in a machine-independent fashion.

What is XDR

XDR is the backbone of Sun Microsystems's Remote Procedure Call package, in the sense that data for RPCs are transmitted using this standard. XDR library routines should be used to transmit data accessed (read or written) by more than one type of machine.

XDR works across different languages, operating systems, and machine architectures. Most users (particularly RPC users) only need the information in the sections on Number Filters, Floating Point Filters, and Enumeration Filters. Programmers wanting to implement RPC and XDR on new machines will be interested in this technical note and the protocol specification.

`rpcgen` can be used to write XDR routines even in cases where no RPC calls are being made.

C programs that use XDR routines must include the file `<rpc/xdr.h>`, which contains all the necessary interfaces to the XDR system. Since the library `libnsl.a` contains all the XDR routines, compile as follows:

```
example% cc program.c
```

In many environments, several criteria must be observed to accomplish porting. It is not always easy to see the ramifications of a small programmatic change, but they

can often have far reaching implications. Consider the examples of a program to read/write a line of text, shown in Code Example A-1 and Code Example A-2.

CODE EXAMPLE A-1 Writer Example (initial)

```
#include <stdio.h>

main()          /* writer.c */
{ int i;

  for (i = 0; i < 8; i++) {
    if (fwrite((char *) &i, sizeof(i), 1, stdout) != 1) {
      fprintf(stderr, "failed!\n");
      exit(1);
    }
  }
  exit(0);
}
```

CODE EXAMPLE A-2 Reader Example (initial)

```
#include <stdio.h>

main()          /* reader.c */
{
  int i, j;

  for (j = 0; j < 8; j++) {
    if (fread((char *) &i, sizeof(i), 1, stdin) != 1) {
      fprintf(stderr, "failed!\n");
      exit(1);
    }
    printf("%ld ", i);
  }
  printf("\n");
  exit(0);
}
```

The two programs appear to be portable, because (a) they pass `lint` checking, and (b) they exhibit the same behavior when executed locally on any hardware architecture.

Piping the output of the `writer` program to the `reader` program gives identical results on SPARC or Intel.

```
sun% writer | reader
0 1 2 3 4 5 6 7
```

```

sun%
intel% writer | reader
0 1 2 3 4 5 6 7
intel%

```

With the advent of local area networks and 4.2BSD came the concept of “network pipes”, which is a process that produces data on one machine, and a second process that consumes data on another machine. A network pipe can be constructed with `writer` and `reader`. Here are the results if the first produces data on a SPARC, and the second consumes data on Intel architecture.

```

sun% writer | rsh intel reader
0 16777216 33554432 50331648 67108864 83886080 100663296
117440512
sun%

```

Identical results can be obtained by executing `writer` on the Intel and `reader` on the SPARC. These results occur because the byte ordering of data differs between the Intel and the SPARC, even though word size is the same.

Note - 16777216 is 2^{24} . When four bytes are reversed, the 1 is placed in the 24th bit.

Whenever data is shared by two or more machine types, there is a need for portable data. Programs can be made data-portable by replacing the `read()` and `write()` calls with calls to an XDR library routine, `xdr_int()`, a filter that knows the standard representation of an int integer in its external form. The revised versions of `writer` are shown in Code Example A-3.

CODE EXAMPLE A-3 Writer Example (XDR modified)

```

#include <stdio.h>
#include <rpc/rpc.h> /* xdr is a sub-library of rpc */

main()          /* writer.c */
{
    XDR xdrs;
    int i;

    xdrstdio_create(&xdrs, stdout, XDR_ENCODE);
    for (i = 0; i < 8; i++) {
        if (!xdr_int(&xdrs, &i)) {
            fprintf(stderr, "failed!\n");
            exit(1);
        }
    }
    exit(0);
}

```

Code Example A-4 shows the revised versions of `reader`.

CODE EXAMPLE A-4 Reader Example (XDR modified)

```
#include <stdio.h>
#include <rpc/rpc.h> /* xdr is a sub-library of rpc */

main()                /* reader.c */
{
    XDR xdrs;
    int i, j;

    xdrstdio_create(&xdrs, stdin, XDR_DECODE);
    for (j = 0; j < 8; j++) {
        if (!xdr_int(&xdrs, &i)) {
            fprintf(stderr, "failed!\n");
            exit(1);
        }
        printf("%ld ", i);
    }
    printf("\n");
    exit(0);
}
```

The new programs were executed on a SPARC, on an Intel, and from a SPARC to an Intel; the results are shown below.

```
sun% writer | reader
0 1 2 3 4 5 6 7
sun%
intel% writer | reader
0 1 2 3 4 5 6 7
intel%
sun% writer | rsh intel reader
0 1 2 3 4 5 6 7
sun%
```

Note - Integers are just the tip of the portable-data iceberg. Arbitrary data structures present portability problems, particularly with respect to alignment and pointers. Alignment on word boundaries may cause the size of a structure to vary from machine to machine. And pointers, which are very convenient to use, have no meaning outside the machine where they are defined.

A Canonical Standard

XDR's approach to standardizing data representations is canonical. That is, XDR defines a single byte order, a single floating-point representation (IEEE), and so on. Any program running on any machine can use XDR to create portable data by translating its local representation to the XDR standard representations. Similarly, any program running on any machine can read portable data by translating the XDR standard representations to its local equivalents. The single standard completely decouples programs that create or send portable data from those that use or receive portable data. The advent of a new machine or a new language has no effect upon the community of existing portable-data creators and users. A new machine joins this community by being "taught" how to convert the standard representations and its local representations; the local representations of other machines are irrelevant. Conversely, the local representations of the new machine are also irrelevant to existing programs running on other machines. Such programs can immediately read portable data produced by the new machine because such data conforms to the canonical standards that they already understand.

There are strong precedents for XDR's canonical approach. For example, TCP/IP, UDP/IP, XNS, Ethernet, and, indeed, all protocols below layer five of the ISO model, are canonical protocols. The advantage of any canonical approach is simplicity; in the case of XDR, a single set of conversion routines is written once and is never touched again. The canonical approach has a disadvantage, but it is unimportant in real-world data transfer applications. Suppose two Intel machines are transferring integers according to the XDR standard. The sending machine converts the integers from Intel host byte order to XDR byte order; the receiving machine performs the reverse conversion. Because both machines observe the same byte order, their conversions are unnecessary.

The time spent converting to and from a canonical representation is insignificant, especially in distributed applications. Most of the time required to prepare a data structure for transfer is not spent in conversion but in traversing the elements of the data structure. To transmit a tree, for example, each leaf must be visited and each element in a leaf record must be copied to a buffer and aligned there; storage for the leaf may have to be de-allocated as well. Similarly, to receive a tree, storage must be allocated for each leaf, data must be moved from the buffer to the leaf and properly aligned, and pointers must be constructed to link the leaves together. Every machine pays the cost of traversing and copying data structures whether or not conversion is required. In distributed applications, communications overhead—the time required to move the data down through the sender's protocol layers, across the network and up through the receiver's protocol layers—dwarfs conversion overhead.

The XDR Library

The XDR library not only solves data portability problems, it also allows you to write and read arbitrary C constructs in a consistent, specified, well-documented manner. Thus, it can make sense to use the library even when the data is not shared among machines on a network.

The XDR library has filter routines for strings (null-terminated arrays of bytes), structures, unions, and arrays, to name a few. Using more primitive routines, you can write your own specific XDR routines to describe arbitrary data structures, including elements of arrays, arms of unions, or objects pointed at from other structures. The structures themselves may contain arrays of arbitrary elements, or pointers to other structures.

Look closely at the two programs. There is a family of XDR stream creation routines in which each member treats the stream of bits differently. In the example, data is manipulated using standard I/O routines, so you use `xdrstdio_create()`. The parameters to XDR stream creation routines vary according to their function. In the example, `xdrstdio_create()` takes a pointer to an XDR structure that it initializes, a pointer to a `FILE` that the input or output is performed on, and the operation. The operation may be `XDR_ENCODE` for serializing in the writer program, or `XDR_DECODE` for deserializing in the reader program.

Note - RPC users never need to create XDR streams; the RPC system itself creates these streams, which are then passed to the users.

The `xdr_int()` primitive is characteristic of most XDR library primitives and all client XDR routines. First, the routine returns `FALSE` (0) if it fails, and `TRUE` (1) if it succeeds. Second, for each data type, `xxx`, there is an associated XDR routine of the form:

```
xdr_xxx(xdrs, xp)
    XDR *xdrs;
    xxx *xp;
{
}
```

In this case, `xxx` is `int`, and the corresponding XDR routine is a primitive, `xdr_int()`. The client could also define an arbitrary structure `xxx` in which case the client would also supply the routine `xdr_xxx()`, describing each field by calling XDR routines of the appropriate type. In all cases the first parameter, `xdrs` can be treated as an opaque handle, and passed to the primitive routines.

XDR routines are direction independent; that is, the same routines are called to serialize or deserialize data. This feature is critical to software engineering of portable data. The idea is to call the same routine for either operation—this almost guarantees that serialized data can also be deserialized. One routine is used by both

producer and consumer of networked data. This is implemented by always passing the address of an object rather than the object itself—only in the case of deserialization is the object modified. This feature is not shown in our trivial example, but its value becomes obvious when nontrivial data structures are passed among machines. If needed, the user can obtain the direction of the XDR operation. For details, see the section “Operation Directions” on page 215.

A slightly more complicated example follows. Assume that a person’s gross assets and liabilities are to be exchanged among processes. Also assume that these values are important enough to warrant their own data type:

```
struct gnumbers {
    int g_assets;
    int g_liabilities;
};
```

The corresponding XDR routine describing this structure is:

```
bool_t          /* TRUE is success, FALSE is failure */
xdr_gnumbers(xdrs, gp)
    XDR *xdrs;
    struct gnumbers *gp;
{
    if (xdr_int(xdrs, &gp->g_assets) &&
        xdr_int(xdrs, &gp->g_liabilities))
        return(TRUE);
    return(FALSE);
}
```

Note that the parameter *xdrs* is never inspected or modified; it is only passed on to the subcomponent routines. It is imperative to inspect the return value of each XDR routine call, and to give up immediately and return `FALSE` if the subroutine fails.

This example also shows that the type `bool_t` is declared as an integer whose only values are `TRUE` (1) and `FALSE` (0). This document uses the following definitions:

```
#define bool_t int
#define TRUE 1
#define FALSE 0
```

Keeping these conventions in mind, `xdr_gnumbers()` can be rewritten as follows:

```
xdr_gnumbers(xdrs, gp)
    XDR *xdrs;
    struct gnumbers *gp;
{
    return(xdr_int(xdrs, &gp->g_assets) &&
           xdr_int(xdrs, &gp->g_liabilities));
}
```

This document uses both coding styles.

XDR Library Primitives

This section gives a synopsis of each XDR primitive. It starts with memory allocation and the basic data types, then moves on to constructed data types. Finally, XDR utilities are discussed. The interface to these primitives and utilities is defined in the include file `<rpc/xdr.h>`, automatically included by `<rpc/rpc.h>`.

Memory Requirements for XDR Routines

When using XDR routines, there is sometimes a need to pre-allocate memory (or to determine memory requirements). In these instances where the developer needs to control the allocation and de-allocation of memory for XDR conversion routines to use there is a routine, `xdr_sizeof()`, that is used to return the number of bytes needed to encode and decode data using one of the XDR filter functions (`func()`). `xdr_sizeof()`'s output does not include RPC headers or record markers and they must be added in to get a complete accounting of the memory required. `xdr_sizeof()` returns a zero on error.

```
xdr_sizeof(xdrproc_t func, void *data)
```

`xdr_sizeof()` is specifically useful the allocation of memory in applications that use XDR outside of the RPC environment; to select between transport protocols; and at the lower levels of RPC to perform client and server creation functions.

Code Example A-5 and Code Example A-6 illustrate two uses of `xdr_sizeof()`.

CODE EXAMPLE A-5 `xdr_sizeof` Example #1

```
#include <rpc/rpc.h>

/*
 * This function takes as input a CLIENT handle, an XDR function
 and
 * a pointer to data to be XDR'd. It returns TRUE if the amount of
 * data to be XDR'd may be sent using the transport associated
 with
 * the CLIENT handle, and false otherwise.
 */
bool_t
cansend(cl, xdrfunc, xdrdata)
CLIENT *cl;
xdrproc_t xdrfunc;
void *xdrdata;
{
    int fd;
    struct t_info tinfo;
```

(continued)

(Continuation)

```
if (clnt_control(cl, CLGET_FD, &fd) == -1) {
    /* handle clnt_control() error */
    return (FALSE);
}

if (t_getinfo(fd, &tinfo) == -1) {
    /* handle t_getinfo() error */
    return (FALSE);
} else {
    if (tinfo.servtype == T_CLTS) {
        /*
         * This is a connectionless transport. Use xdr_sizeof()
         * to compute the size of this request to see whether it
         * is too large for this transport.
         */
        switch(tinfo.tsdu) {
            case 0: /* no concept of TSDUs */
            case -2: /* can't send normal data */
                return (FALSE);
                break;
            case -1: /* no limit on TSDU size */
                return (TRUE);
                break;
            default:
                if (tinfo.tsdu < xdr_sizeof(xdrfunc, xdrdata))
                    return (FALSE);
                else
                    return (TRUE);
        }
    } else
        return (TRUE);
}
}
```

Code Example A-6 is the second `xdr_sizeof()` example.

CODE EXAMPLE A-6 `xdr_sizeof` Example #2

```
#include <sys/statvfs.h>
#include <sys/sysmacros.h>

/*
 * This function takes as input a file name, an XDR function, and
 * a
 * pointer to data to be XDR'd. It returns TRUE if the filesystem
 * on which the file resides has room for the additional amount
```

(continued)

(Continuation)

```
of
 * data to be XDR'd. Note that since the information statvfs(2)
 * returns about the filesystem is in blocks you must convert the
 * value returned by xdr_sizeof() from bytes to disk blocks.
 */
bool_t
canwrite(file, xdrfunc, xdrdata)
char      *file;
xdrproc_t xdrfunc;
void      *xdrdata;
{
    struct statvfs s;

    if (statvfs(file, &s) == -1) {
        /* handle statvfs() error */
        return (FALSE);
    }

    if (s.f_bavail >= btod(xdr_sizeof(xdrfunc, xdrdata)))
        return (TRUE);
    else
        return (FALSE);
}
```

Number Filters

The XDR library provides primitives to translate between numbers and their corresponding external representations. Primitives cover the set of numbers in the types:

[signed, unsigned] * [short, int, long]

Specifically, the eight primitives are:

```
bool_t xdr_char(xdrs, op)
    XDR *xdrs;
    char *cp;
bool_t xdr_u_char(xdrs, ucp)
    XDR *xdrs;
    unsigned char *ucp;
bool_t xdr_int(xdrs, ip)
    XDR *xdrs;
    int *ip;
bool_t xdr_u_int(xdrs, up)
    XDR *xdrs;
    unsigned *up;
bool_t xdr_long(xdrs, lip)
    XDR *xdrs;
    long *lip;
bool_t xdr_u_long(xdrs, lup)
```

```

    XDR *xdrs;
    u_long *lup;
bool_t xdr_short(xdrs, sip)
    XDR *xdrs;
    short *sip;
bool_t xdr_u_short(xdrs, sup)
    XDR *xdrs;
    u_short *sup;

```

The first parameter, *xdrs*, is an XDR stream handle. The second parameter is the address of the number that provides data to the stream or receives data from it. All routines return `TRUE` if they complete successfully, and `FALSE` otherwise.

Floating Point Filters

The XDR library also provides primitive routines for C floating point types:

```

bool_t xdr_float(xdrs, fp)
    XDR *xdrs;
    float *fp;
bool_t xdr_double(xdrs, dp)
    XDR *xdrs;
    double *dp;

```

The first parameter, *xdrs* is an XDR stream handle. The second parameter is the address of the floating point number that provides data to the stream or receives data from it. Both routines return `TRUE` if they complete successfully, and `FALSE` otherwise.

Note - Since the numbers are represented in IEEE floating point, routines may fail when decoding a valid IEEE representation into a machine-specific representation, or vice versa.

Enumeration Filters

The XDR library provides a primitive for generic enumerations. The primitive assumes that a C `enum` has the same representation inside the machine as a C integer. The Boolean type is an important instance of the `enum`. The external representation of a Boolean is always `TRUE` (1) or `FALSE` (0).

```

#define bool_t int
#define FALSE 0
#define TRUE 1
#define enum_t int
bool_t xdr_enum(xdrs, ep)
    XDR *xdrs;
    enum_t *ep;

```

```
bool_t xdr_bool(xdrs, bp)
    XDR *xdrs;
    bool_t *bp;
```

The second parameters *ep* and *bp* are addresses of the associated type that provides data to, or receives data from, the stream *xdrs*.

No-Data Routine

Occasionally, an XDR routine must be supplied to the RPC system, even when no data is passed or required. The library provides such a routine:

```
bool_t xdr_void(); /* always returns TRUE */
```

Constructed Data Type Filters

Constructed or compound data type primitives require more parameters and perform more complicated functions than the primitives discussed previously. This section includes primitives for strings, arrays, unions, and pointers to structures.

Constructed data type primitives may use memory management. In many cases, memory is allocated when deserializing data with `XDR_DECODE`. Therefore, the XDR package must provide means to de-allocate memory. This is done by an XDR operation, `XDR_FREE`. To review, the three XDR directional operations are `XDR_ENCODE`, `XDR_DECODE`, and `XDR_FREE`.

Strings

In the C language, a string is defined as a sequence of bytes terminated by a null byte, which is not considered when calculating string length. However, when a string is passed or manipulated, a pointer to it is employed. Therefore, the XDR library defines a string to be a `char *`, and not a sequence of characters. The external representation of a string is drastically different from its internal representation.

Externally strings are represented as sequences of ASCII characters, while internally they are represented with character pointers. Conversion between the two representations is accomplished with the routine `xdr_string()`:

```
bool_t xdr_string(xdrs, sp, maxlength)
    XDR *xdrs;
    char **sp;
    u_int maxlength;
```

The first parameter *xdrs* is the XDR stream handle. The second parameter *sp* is a pointer to a string (type `char **`). The third parameter *maxlength* specifies the maximum number of bytes allowed during encoding or decoding. Its value is usually specified by a protocol. For example, a protocol specification may say that a

file name may be no longer than 255 characters. The routine returns `FALSE` if the number of characters exceeds *maxlength*, and `TRUE` if it doesn't.

The behavior of `xdr_string()` is similar to the behavior of other routines discussed in this section. The direction `XDR_ENCODE` is easiest to understand. The parameter *sp* points to a string of a certain length; if the string does not exceed *maxlength*, the bytes are serialized.

The effect of deserializing a string is subtle. First the length of the incoming string is determined; it must not exceed *maxlength*. Next *sp* is dereferenced; if the value is `NULL`, a string of the appropriate length is allocated and **sp* is set to this string. If the original value of **sp* is nonnull, the XDR package assumes that a target area has been allocated, which can hold strings no longer than *maxlength*. In either case, the string is decoded into the target area. The routine then appends a null character to the string.

In the `XDR_FREE` operation the string is obtained by dereferencing *sp*. If the string is not `NULL`, it is freed and **sp* is set to `NULL`. In this operation `xdr_string()` ignores the *maxlength* parameter.

Note that you can use XDR on an empty string ("") but not on a `NULL` string.

Byte Arrays

Often variable-length arrays of bytes are preferable to strings. Byte arrays differ from strings in the following three ways: (1) the length of the array (the byte count) is explicitly located in an unsigned integer, (2) the byte sequence is not terminated by a null character, and (3) the external representation of the bytes is the same as their internal representation. The primitive `xdr_bytes()` converts between the internal and external representations of byte arrays:

```
bool_t xdr_bytes(xdrs, bpp, lp, maxlength)
    XDR *xdrs;
    char **bpp;
    u_int *lp;
    u_int maxlength;
```

The usage of the first, second, and fourth parameters is identical to the first, second and third parameters of `xdr_string()` respectively. The length of the byte area is obtained by dereferencing *lp* when serializing; **lp* is set to the byte length when deserializing.

Arrays

The XDR library package provides a primitive for handling arrays of arbitrary elements. The `xdr_bytes()` routine treats a subset of generic arrays, in which the size of array elements is known to be 1, and the external description of each element is built-in. The generic array primitive, `xdr_array()` requires parameters identical

to those of `xdr_bytes()` plus two more: the size of array elements, and an XDR routine to handle each of the elements. This routine is called to encode or decode each element of the array.

```
bool_t
xdr_array(xdrs, ap, lp, maxlength, elementsize, xdr_element)
    XDR *xdrs;
    char **ap;
    u_int *lp;
    u_int maxlength;
    u_int elementsize;
    bool_t (*xdr_element)();
```

The parameter *ap* is the address of the pointer to the array. If **ap* is NULL when the array is being deserialized, XDR allocates an array of the appropriate size and sets **ap* to that array. The element count of the array is obtained from **lp* when the array is serialized; **lp* is set to the array length when the array is deserialized. The parameter *maxlength* is the maximum number of elements that the array is allowed to have; *elementsiz*e is the byte size of each element of the array (the C function `sizeof()` can be used to obtain this value). The `xdr_element()` routine is called to serialize, deserialize, or free each element of the array.

Before defining more constructed data types, it is appropriate to present three examples.

Array Example 1

A user on a networked machine can be identified by (a) the machine name, such as `krypton`; (b) the user's UID: see the `geteuid` man page; and (c) the group numbers to which the user belongs: see the `getgroups` man page. A structure with this information and its associated XDR routine could be coded as in Code Example A-7.

CODE EXAMPLE A-7 Array Example #1

```
struct netuser {
    char *nu_machinename;
    int nu_uid;
    u_int nu_glen;
    int *nu_gids;
};
#define NLEN 255 /* machine names < 256 chars */
#define NGRPS 20 /* user can't be in > 20 groups */

bool_t
xdr_netuser(xdrs, nup)
    XDR *xdrs;
    struct netuser *nup;
{
    return(xdr_string(xdrs, &nup->nu_machinename, NLEN) &&
        xdr_int(xdrs, &nup->nu_uid) &&
        xdr_array(xdrs, &nup->nu_gids, &nup->nu_glen, NGRPS,
            sizeof (int), xdr_int));
}
```

Array Example 2

A party of network users could be implemented as an array of `netuser` structure. The declaration and its associated XDR routines are as shown in Code Example A-8.

CODE EXAMPLE A-8 Array Example #2

```
struct party {
    u_int p_len;
    struct netuser *p_nusers;
};
#define PLEN 500 /* max number of users in a party */
bool_t
xdr_party(xdrs, pp)
    XDR *xdrs;
    struct party *pp;
{
    return(xdr_array(xdrs, &pp->p_nusers, &pp->p_len, PLEN,
        sizeof (struct netuser), xdr_netuser));
}
```

Array Example 3

The well-known parameters to `main`, `argc` and `argv` can be combined into a structure. An array of these structures can make up a history of commands. The declarations and XDR routines might look like Code Example A-9.

CODE EXAMPLE A-9 Array Example #3

```
struct cmd {
    u_int c_argc;
    char **c_argv;
};
#define ALEN 1000 /* args cannot be > 1000 chars */
#define NARGC 100 /* commands cannot have > 100 args */

struct history {
    u_int h_len;
    struct cmd *h_cmds;
};
#define NCMD5 75 /* history is no more than 75 commands */

bool_t
xdr_wrapstring(xdrs, sp)
    XDR *xdrs;
    char **sp;
{
    return(xdr_string(xdrs, sp, ALEN));
}

bool_t
xdr_cmd(xdrs, cp)
    XDR *xdrs;
```

```

    struct cmd *cp;
    {
        return(xdr_array(xdrs, &cp->c_argv, &cp->c_argc, NARGC,
            sizeof (char *), xdr_wrapstring));
    }
    bool_t
    xdr_history(xdrs, hp)

    XDR *xdrs;
    struct history *hp;
    {
        return(xdr_array(xdrs, &hp->h_cmds, &hp->h_len, NCMDs,
            sizeof (struct cmd), xdr_cmd));
    }
}

```

The most confusing part of this example is that the routine `xdr_wrapstring()` is needed to package the `xdr_string()` routine, because the implementation of `xdr_array()` passes only two parameters to the array element description routine; `xdr_wrapstring()` supplies the third parameter to `xdr_string()`.

By now the recursive nature of the XDR library should be obvious. Let's continue with more constructed data types.

Opaque Data

In some protocols, handles are passed from a server to client. The client passes the handle back to the server at some later time. Handles are never inspected by clients; they are obtained and submitted. That is to say, handles are opaque. The `xdr_opaque()` primitive is used for describing fixed sized, opaque bytes.

```

bool_t
xdr_opaque(xdrs, p, len)
    XDR *xdrs;
    char *p;
    u_int len;

```

The parameter *p* is the location of the bytes; *len* is the number of bytes in the opaque object. By definition, the actual data contained in the opaque object are not machine portable.

In SunOS/SVR4 there is another routine for manipulating opaque data. This routine, `xdr_netobj` sends counted opaque data, much like `xdr_opaque()`. Code Example A-10 illustrates the syntax of `xdr_netobj()`.

CODE EXAMPLE A-10 `xdr_netobj` Routine

```

struct netobj {
    u_int    n_len;
    char    *n_bytes;
};
typedef struct netobj netobj;

```

```

bool_t
xdr_netobj(xdrs, np)
    XDR *xdrs;
    struct netobj *np;

```

The `xdr_netobj()` routine is a filter primitive that translates between variable length opaque data and its external representation. The parameter `np` is the address of the `netobj` structure containing both a length and a pointer to the opaque data. The length may be no more than `MAX_NETOBJ_SZ` bytes. This routine returns `TRUE` if it succeeds, `FALSE` otherwise.

Fixed-Length Arrays

The XDR library provides a primitive, `xdr_vector()`, for fixed-length arrays, shown in Code Example A-11.

CODE EXAMPLE A-11 `xdr_vector` Routine

```

#define NLEN 255 /* machine names must be < 256 chars */
#define NGRPS 20 /* user belongs to exactly 20 groups */

struct netuser {
    char *nu_machinename;
    int nu_uid;
    int nu_gids[NGRPS];
};

bool_t
xdr_netuser(xdrs, nup)
    XDR *xdrs;
    struct netuser *nup;
{
    int i;

    if (!xdr_string(xdrs, &nup->nu_machinename, NLEN))
        return(FALSE);
    if (!xdr_int(xdrs, &nup->nu_uid))
        return(FALSE);
    if (!xdr_vector(xdrs, nup->nu_gids, NGRPS, sizeof(int),
        xdr_int))
        return(FALSE);
    return(TRUE);
}

```

Discriminated Unions

The XDR library supports discriminated unions. A discriminated union is a C union and an `enum_t` value that selects an “arm” of the union.

```

struct xdr_discrim {
    enum_t value;
    bool_t (*proc)();
}

```

```

};

bool_t
xdr_union(xdrs, dscmp, unp, arms, defaultarm)
    XDR *xdrs;
    enum_t *dscmp;
    char *unp;
    struct xdr_discrim *arms;
    bool_t (*defaultarm)(); /* may equal NULL */

```

First the routine translates the discriminant of the union located at **dscmp*. The discriminant is always an `enum_t`. Next the union located at **unp* is translated. The parameter *arms* is a pointer to an array of `xdr_discrim` structures. Each structure contains an ordered pair of [*value,proc*]. If the union's discriminant is equal to the associated *value*, then the `proc` is called to translate the union. The end of the `xdr_discrim` structure array is denoted by a routine of value `NULL (0)`. If the discriminant is not found in the *arms* array, then the `defaultarm()` procedure is called if it is nonnull; otherwise the routine returns `FALSE`.

Discriminated Union Example

Suppose the type of a union may be integer, character pointer (a string), or a `gnumbers` structure. Also, assume the union and its current type are declared in a structure. The declaration is:

```

enum utype {INTEGER=1, STRING=2, GNUMBERS=3};
struct u_tag {
    enum utype utype; /* the union's discriminant */
    union {
        int ival;
        char *pval;
        struct gnumbers gn;
    } uval;
};

```

Code Example A-12 constructs and XDR procedure (de)serialize the discriminated union.

CODE EXAMPLE A-12 XDR Discriminated Union

```

struct xdr_discrim u_tag_arms[4] = {
    {INTEGER, xdr_int},
    {GNUMBERS, xdr_gnumbers},
    {STRING, xdr_wrapstring},
    {__dontcare__, NULL}
    /* always terminate arms with a NULL xdr_proc */
}

bool_t
xdr_u_tag(xdrs, utp)
    XDR *xdrs;

```

```

    struct u_tag *utp;
    {
        return(xdr_union(xdrs, &utp->utype, &utp->uval,
            u_tag_arms, NULL));
    }

```

The routine `xdr_gnumbers()` was presented above in the XDR Library section. `xdr_wrapstring()` was presented in example C. The default *arm* parameter to `xdr_union()` (the last parameter) is `NULL` in this example. Therefore the value of the union's discriminant may legally take on only values listed in the `u_tag_arms` array. This example also demonstrates that the elements of the arm's array do not need to be sorted.

It is worth pointing out that the values of the discriminant may be sparse, though in this example they are not. It is always good practice to assign explicitly integer values to each element of the discriminant's type. This practice both documents the external representation of the discriminant and guarantees that different C compilers emit identical discriminant values.

Exercise

Implement `xdr_union()` using the other primitives in this section.

Pointers

In C it is often convenient to put pointers to another structure within a structure. The `xdr_reference()` primitive makes it easy to serialize, deserialize, and free these referenced structures.

```

bool_t
xdr_reference(xdrs, pp, size, proc)
    XDR *xdrs;
    char **pp;
    u_int ssize;
    bool_t (*proc)();

```

Parameter *pp* is the address of the pointer to the structure; parameter *ssize* is the size in bytes of the structure (use the C function `sizeof()` to obtain this value); and `proc()` is the XDR routine that describes the structure. When decoding data, storage is allocated if *pp* is `NULL`.

There is no need for a primitive `xdr_struct()` to describe structures within structures, because pointers are always sufficient.

Exercise

Implement `xdr_reference()` using `xdr_array()`.



Warning - `xdr_reference()` and `xdr_array()` are *NOT* interchangeable external representations of data.

Pointer Example

Suppose there is a structure containing a person's name and a pointer to a `gnumbers` structure containing the person's gross assets and liabilities. The construct is:

```
struct pgn {
    char *name;
    struct gnumbers *gnp;
};
```

The corresponding XDR routine for this structure is:

```
bool_t
xdr_pgn(xdrs, pp)
    XDR *xdrs;
    struct pgn *pp;
{
    return(xdr_string(xdrs, &pp->name, NLEN) &&
        xdr_reference(xdrs, &pp->gnp, sizeof(struct gnumbers),
            xdr_gnumbers));
}
```

Pointer Semantics

In many applications, C programmers attach double meaning to the values of a pointer. Typically the value `NULL` (or zero) means data is not needed, yet some application-specific interpretation applies. In essence, the C programmer is encoding a discriminated union efficiently by overloading the interpretation of the value of a pointer. For instance, in example E a `NULL` pointer value for `gnp` could indicate that the person's assets and liabilities are unknown. That is, the pointer value encodes two things: whether or not the data is known; and if it is known, where it is located in memory. Linked lists are an extreme example of the use of application-specific pointer interpretation.

The primitive `xdr_reference()` cannot and does not attach any special meaning to a null-value pointer during serialization. That is, passing an address of a pointer whose value is `NULL` to `xdr_reference()` when serializing data will most likely cause a memory fault and, on the UNIX system, a core dump.

`xdr_pointer()` correctly handles `NULL` pointers.

Nonfilter Primitives

XDR streams can be manipulated with the primitives discussed in this section.

```

u_int xdr_getpos(xdrs)
    XDR *xdrs;

bool_t xdr_setpos(xdrs, pos)
    XDR *xdrs;
    u_int pos;

xdr_destroy(xdrs)
    XDR *xdrs;

```

The routine `xdr_getpos()`

returns an unsigned integer that describes the current position in the data stream. **Warning:** In some XDR streams, the value returned by `xdr_getpos()` is meaningless; the routine returns a -1 in this case (though -1 should be a legitimate value).

The routine `xdr_setpos()` sets a stream position to *pos*. **Warning:** In some XDR streams, setting a position is impossible; in such cases, `xdr_setpos()` will return `FALSE`. This routine will also fail if the requested position is out-of-bounds. The definition of bounds varies from stream to stream.

The `xdr_destroy()` primitive destroys the XDR stream. Usage of the stream after calling this routine is undefined.

Operation Directions

At times you may want to optimize XDR routines by taking advantage of the direction of the operation—`XDR_ENCODE`, `XDR_DECODE` or `XDR_FREE`. The value `xdrs->x_op` always contains the direction of the XDR operation. An example in “Linked Lists” on page 220 demonstrates the usefulness of the `xdrs->x_op` field.

Stream Access

An XDR stream is obtained by calling the appropriate creation routine. These creation routines take arguments that are tailored to the specific properties of the stream. Streams currently exist for (de)serialization of data to or from standard I/O `FILE` streams, record streams, and UNIX files, and memory.

Standard I/O Streams

XDR streams can be interfaced to standard I/O using the `xdrstdio_create()` routine:

```

#include <stdio.h>
#include <rpc/rpc.h> /* xdr is part of rpc */

```

```

void
xdrstdio_create(xdrs, fp, xdr_op)
    XDR *xdrs;
    FILE *fp;
    enum xdr_op x_op;

```

The routine `xdrstdio_create()` initializes an XDR stream pointed to by `xdrs`. The XDR stream interfaces to the standard I/O library. Parameter `fp` is an open file, and `x_op` is an XDR direction.

Memory Streams

Memory streams allow the streaming of data into or out of a specified area of memory:

```

#include <rpc/rpc.h>

void
xdrmem_create(xdrs, addr, len, x_op)
    XDR *xdrs;
    char *addr;
    u_int len;
    enum xdr_op x_op;

```

The routine `xdrmem_create()` initializes an XDR stream in local memory. The memory is pointed to by parameter `addr`; parameter `len` is the length in bytes of the memory. The parameters `xdrs` and `x_op` are identical to the corresponding parameters of `xdrstdio_create()`. Currently, the datagram implementation of RPC uses `xdrmem_create()`. Complete call or result messages are built in memory before calling the `t_sndndata()` TLI routine.

Record (TCP/IP) Streams

A record stream is an XDR stream built on top of a record marking standard that is built on top of the UNIX file or 4.2 BSD connection interface.

```

#include <rpc/rpc.h>      /* xdr is part of rpc */

xdrrec_create(xdrs, sendsize, recvsize, iohandle, readproc,
             writeproc)
    XDR *xdrs;
    u_int sendsize, recvsize;
    char *iohandle;
    int (*readproc)(), (*writeproc)();

```

The routine `xdrrec_create()` provides an XDR stream interface that allows for a bidirectional, arbitrarily long sequence of records. The contents of the records are

meant to be data in XDR form. The stream's primary use is for interfacing RPC to TCP connections. However, it can be used to stream data into or out of normal UNIX files.

The parameter *xdrs* is similar to the corresponding parameter described above. The stream does its own data buffering similar to that of standard I/O. The parameters *sendsize* and *recvsize* determine the size in bytes of the output and input buffers, respectively; if their values are zero (0), then predetermined defaults are used. When a buffer needs to be filled or flushed, the routine `readproc()` or `writeproc()` is called, respectively. The usage and behavior of these routines are similar to the UNIX system calls `read()` and `write()`. However, the first parameter to each of these routines is the opaque parameter *iohandle*. The other two parameters (and *nbytes*) and the results (byte count) are identical to the system routines. If `xxx()` is `readproc()` or `writeproc()`, then it has the following form:

```
/* returns the actual number of bytes transferred. -1 is an error */int
xxx(iohandle, buf, len)
    char *iohandle;
    char *buf;
    int nbytes;
```

The XDR stream provides means for delimiting records in the byte stream. Abstract data types needed to implement the XDR stream mechanism are discussed in "XDR Stream Implementation" on page 218. The protocol RPC uses to delimit XDR stream records is discussed in "Record-Marking Standard" on page 232.

The primitives that are specific to record streams are as follows:

```
bool_t
xdrrec_endofrecord(xdrs, flushnow)
    XDR *xdrs;
    bool_t flushnow;

bool_t
xdrrec_skiprecord(xdrs)
    XDR *xdrs;

bool_t
xdrrec_eof(xdrs)
    XDR *xdrs;
```

The routine `xdrrec_endofrecord()` causes the current outgoing data to be marked as a record. If the parameter *flushnow* is `TRUE`, then the stream's `writeproc()` will be called; otherwise, `writeproc()` will be called when the output buffer has been filled.

The routine `xdrrec_skiprecord()` causes an input stream's position to be moved past the current record boundary and onto the beginning of the next record in the stream.

If there is no more data in the stream's input buffer, then the routine `xdrrec_eof()` returns `TRUE`. That is not to say that there is no more data in the underlying file descriptor.

XDR Stream Implementation

This section provides the abstract data types needed to implement new instances of XDR streams.

The XDR Object

The structure in Code Example A-13 defines the interface to an XDR stream.

CODE EXAMPLE A-13 XDR Stream Interface Example

```
enum xdr_op {XDR_ENCODE=0, XDR_DECODE=1, XDR_FREE=2};

typedef struct {
    enum xdr_op x_op;
    struct xdr_ops {
        bool_t (*x_getlong)();           /* get long from stream */
        bool_t (*x_putlong)();           /* put long to stream */
        bool_t (*x_getbytes)();          /* get bytes from stream */
        bool_t (*x_putbytes)();          /* put bytes to stream */
        u_int (*x_getpostn)();           /* return stream offset */
        bool_t (*x_setpostn)();          /* reposition offset */
        caddr_t (*x_inline)();           /* ptr to buffered data */
        VOID (*x_destroy)();             /* free private area */
        bool_t (*x_control)();           /* change, retrieve client info */
        bool_t (*x_getint32)();          /* get int from stream */
        bool_t (*x_putint32)();          /* put into stream */
    } *x_ops;
    caddr_t x_public;                    /* users' data */
    caddr_t x_private;                   /* pointer to private data */
    caddr_t x_base;                      /* private for position info */
    int x_handy;                         /* extra private word */
} XDR;
```

The `x_op` field is the current operation being performed on the stream. This field is important to the XDR primitives, but should not affect a stream's implementation. That is, a stream's implementation should not depend on this value. The fields `x_private`, `x_base`, and `x_handy` are private to the particular stream's implementation. The field `x_public` is for the XDR client and should never be used by the XDR stream implementations or the XDR primitives. `x_getpostn()`, `x_setpostn()`, and `x_destroy()` are macros for accessing operations. The operation `x_inline()` has two parameters: an XDR *, and an unsigned integer, which is a byte count. The routine returns a pointer to a piece of the stream's internal buffer. The caller can then use the buffer segment for any purpose. From the

stream's point of view, the bytes in the buffer segment have been consumed. The routine may return NULL if it cannot return a buffer segment of the requested size. (The `x_inline()` routine is used to squeeze cycles, and the resulting buffer is not data portable. Users are cautioned against using this feature.)

The operations `x_getbytes()` and `x_putbytes()` blindly get and put sequences of bytes from or to the underlying stream; they return TRUE if they are successful, and FALSE otherwise. The routines have identical parameters (replace xxx):

```
bool_t
xxxbytes(xdrs, buf, bytecount)
    XDR *xdrs;
    char *buf;
    u_int bytecount;
```

The operations `x_getint32()` and `x_putint32()` receive and put int numbers from and to the data stream. It is the responsibility of these routines to translate the numbers between the machine representation and the (standard) external representation. The UNIX primitives `htonl()` and `ntohl()` can be helpful in accomplishing this. The higher-level XDR implementation assumes that signed and unsigned integers contain the same number of bits, and that nonnegative integers have the same bit representations as unsigned integers. The routines return TRUE if they succeed, and FALSE otherwise.

The `x_getint()` and `x_putint()` functions make use of these operations. They have identical parameters:

```
bool_t
xxxint(xdrs, ip)
    XDR *xdrs;
    int32_t *ip;
```

The long version of these operations (`x_getlong()` and `x_putlong()`) also call `x_getint32()` and `x_putint32()`, ensuring that a 4-byte quantity is operated on, no matter what machine the program is running on.

Implementors of new XDR streams must make an XDR structure (with new operation routines) available to clients, using some kind of create routine.

Advanced Topics

This section describes techniques for passing data structures that are not covered in the preceding sections. Such structures include linked lists (of arbitrary lengths). Unlike the simpler examples covered in the earlier sections, the following examples are written using both the XDR C library routines and the XDR data description language. Appendix C describes this language in detail.

Linked Lists

The “Pointer Example” on page 214 presented a C data structure and its associated XDR routines for an individual’s gross assets and liabilities. Code Example A-14 uses a linked list to duplicate the pointer example.

CODE EXAMPLE A-14 Linked List

```
struct gnumbers {
    int g_assets;
    int g_liabilities;
};

bool_t
xdr_gnumbers(xdrs, gp)
    XDR *xdrs;
    struct gnumbers *gp;
{
    return(xdr_int(xdrs, &(gp->g_assets) &&
        xdr_int(xdrs, &(gp->g_liabilities)));
}
```

Now assume that you want to implement a linked list of such information. A data structure could be constructed as follows:

```
struct gnumbers_node {
    struct gnumbers gn_numbers;
    struct gnumbers_node *gn_next;
};
typedef struct gnumbers_node *gnumbers_list;
```

The head of the linked list can be thought of as the data object; that is, the head is not merely a convenient shorthand for a structure. Similarly the `gn_next` field is used to indicate whether the object has terminated. Unfortunately, if the object continues, the `gn_next` field is also the address of where it continues. The link addresses carry no useful information when the object is serialized.

The XDR data description of this linked list is described by the recursive declaration of `gnumbers_list`:

```
struct gnumbers {
    int g_assets;
    int g_liabilities;
};
struct gnumbers_node {
    gnumbers gn_numbers;
    gnumbers_node *gn_next;
};
```

In this description, the Boolean indicates whether there is more data following it. If the Boolean is `FALSE`, it is the last data field of the structure. If it is `TRUE`, it is followed by a `gnumbers` structure and (recursively) by a `gnumbers_list`. Note that the C declaration has no Boolean explicitly declared in it (though the `gn_next` field implicitly carries the information), while the XDR data description has no pointer explicitly declared in it.

Hints for writing the XDR routines for a `gnumbers_list` follow easily from the XDR description above. Note how the primitive `xdr_pointer()` is used to implement the XDR union above.

CODE EXAMPLE A-15 `xdr_pointer`

```
bool_t
xdr_gnumbers_node(xdrs, gn)
    XDR *xdrs;
    gnumbers_node *gn;
{
    return(xdr_gnumbers(xdrs, &gn->gn_numbers) &&
           xdr_gnumbers_list(xdrs, &gn->gn_next));
}

bool_t
xdr_gnumbers_list(xdrs, gnp)
    XDR *xdrs;
    gnumbers_list *gnp;
{
    return(xdr_pointer(xdrs, gnp, sizeof(struct gnumbers_node),
                      xdr_gnumbers_node));
    xdr_pointer}
}
```

The unfortunate side effect of using XDR on a list with these routines is that the C stack grows linearly with respect to the number of nodes in the list. This is due to the recursion. Code Example A-16 collapses the above two mutually recursive routines into a single, nonrecursive one.

CODE EXAMPLE A-16 Nonrecursive Stack in XDR

```
bool_t
xdr_gnumbers_list(xdrs, gnp)
    XDR *xdrs;
    gnumbers_list *gnp;
{
    bool_t more_data;
    gnumbers_list *nextp;

    for(;;) {
        more_data = (*gnp != NULL);
        if (!xdr_bool(xdrs, &more_data))
            return(FALSE);
        if (!more_data)
            break;
        if (xdrs->x_op == XDR_FREE)
            nextp = &(*gnp)->gn_next;
        if (!xdr_reference(xdrs, gnp,
                           sizeof(struct gnumbers_node), xdr_gnumbers))
            return(FALSE);
        gnp = (xdrs->x_op == XDR_FREE) ? nextp : &(*gnp)->gn_next;
    }
    *gnp = NULL;
    return(TRUE);
}
```

The first task is to find out whether there is more data, so that this Boolean information can be serialized. Notice that this statement is unnecessary in the `XDR_DECODE` case, since the value of `more_data` is not known until you deserialize it in the next statement.

The next statement implements XDR on the `more_data` field of the XDR union. Then if there is truly no more data, you set this last pointer to `NULL` to indicate the end of the list, and return `TRUE` because you are done. Note that setting the pointer to `NULL` is only important in the `XDR_DECODE` case, since it is already `NULL` in the `XDR_ENCODE` and `XDR_FREE` cases.

Next, if the direction is `XDR_FREE`, the value of `nextp` is set to indicate the location of the next pointer in the list. We do this now because you need to dereference `gnp` to find the location of the next item in the list, and after the next statement, the storage pointed to by `gnp` will be freed up and no longer valid. We can't do this for all directions though, because in the `XDR_DECODE` direction the value of `gnp` won't be set until the next statement.

Next, you XDR the data in the node using the primitive `xdr_reference()`. `xdr_reference()` is like `xdr_pointer()` which you used before, but it does not send over the Boolean indicating whether there is more data. We use it instead of `xdr_pointer()` because you have already used XDR on this information yourself. Notice that the XDR routine passed is not the same type as an element in the list. The routine passed is `xdr_gnumbers()`, but each element in the list is actually of type `gnumbers_node`. You don't pass `xdr_gnumbers_node()` because it is recursive. Instead use `xdr_gnumbers()` which uses XDR on all of the nonrecursive part. Note that this trick works only if the `gn_numbers` field is the first item in each element, so that their addresses are identical when passed to `xdr_reference()`.

Finally, you update `gnp` to point to the next item in the list. If the direction is `XDR_FREE`, you set it to the previously saved value; otherwise you can dereference `gnp` to get the proper value. Though harder to understand than the recursive version, this nonrecursive routine will run more efficiently since much of the procedure call overhead has been removed. Most lists are small though (in the hundreds of items or less) and the recursive version should be sufficient for them.

RPC Protocol and Language Specification

This appendix specifies a message protocol used in implementing the RPC package. The message protocol is specified with the XDR language. The companion appendix to this one is Appendix C.

- “Protocol Overview” on page 223
- “Program and Procedure Numbers” on page 226
- “Authentication Protocols” on page 232
- “The RPC Language Specification” on page 243

Protocol Overview

The RPC protocol provides for the following:

- Unique specification of a procedure to be called.
- Provisions for matching response messages to request messages.
- Provisions for authenticating the caller to service and vice-versa. In addition, the RPC package provides features that detect the following:
 - RPC protocol mismatches
 - Remote program protocol version mismatches
 - Protocol errors (such as incorrect specification of a procedure’s parameters)
 - Reasons why remote authentication failed

Consider a network file service composed of two programs. One program may deal with high-level applications such as file system access control and locking. The other

may deal with low-level file I/O and have procedures like “read” and “write.” A client machine of the network file service would call the procedures associated with the two programs of the service on behalf of some user on the client machine. In the client-server model a remote procedure call is used to call the service.

The RPC Model

The RPC model is similar to the local procedure call model. In the local case, the caller places arguments to a procedure in some well-specified location. The caller then transfers control to the procedure, and eventually regains control. At that point, the results of the procedure are extracted from a well-specified location, and the caller continues execution.

The RPC is similar, in that one thread of control logically winds through two processes. One is the caller’s process, the other is a server’s process. Conceptually, the caller process sends a call message to the server process and waits (blocks) for a reply message. The call message contains the procedure’s parameters, among other things. The reply message contains the procedure’s results, among other things. Once the reply message is received, the results of the procedure are extracted, and the caller’s execution is resumed.

On the server side, a process is dormant awaiting the arrival of a call message. When one arrives, the server process extracts the procedure’s parameters, computes the results, sends a reply message, and then awaits the next call message.

Note that in this description only one of the two processes is active at any given time. However, this need not be the case. The RPC protocol makes no restrictions on the concurrency model implemented. For example, an implementation may choose to have RPC calls be asynchronous, so that the client may do useful work while waiting for the reply from the server. Another possibility is to have the server create a task to process an incoming request, so that the server can be free to receive other requests.

Transports and Semantics

The RPC protocol is independent of transport protocols. That is, RPC disregards how a message is passed from one process to another. The protocol deals only with specification and interpretation of messages.

RPC does not attempt to ensure transport reliability. Therefore, you must supply the application with information about the type of transport protocol used under RPC. If you tell the RPC service it is running on top of a reliable transport such as TCP, most of the work is already done for it. On the other hand, if RPC is running on top of an unreliable transport such as UDP, the service must devise its own retransmission and time-out policy. RPC does not provide this service.

Because of transport independence, the RPC protocol does not attach specific semantics to the remote procedures or their execution. Semantics can be inferred from (but should be explicitly specified by) the underlying transport protocol. For example, consider RPC running on top of an unreliable transport. If an application retransmits RPC messages after short time-outs, the only thing it can infer if it receives no reply is that the procedure was executed zero or more times. If it does receive a reply, it can infer that the procedure was executed at least once.

A server may choose to remember previously granted requests from a client and not regrant them to insure some degree of execute-at-most-once semantics. A server can do this by taking advantage of the transaction ID that is packaged with every RPC request. The main use of this transaction ID is by the RPC client for matching replies to requests. However, a client application may choose to reuse its previous transaction ID when retransmitting a request. The server application, checking this fact, may choose to remember this ID after granting a request and not regrant requests with the same ID. The server is not allowed to examine this ID in any other way except as a test for equality.

On the other hand, if using a reliable transport such as TCP, the application can infer from a reply message that the procedure was executed exactly once, but if it receives no reply message, it cannot assume the remote procedure was not executed. Note that even if a connection-oriented protocol like TCP is used, an application still needs time-outs and reconnection to handle server crashes.

Binding and Rendezvous Independence

The act of binding a client to a service is not part of the remote procedure call specification. This important and necessary function is left up to some higher-level software. (The software may use RPC itself; see “`rpcbind` Protocol” on page 251.)

Implementers should think of the RPC protocol as the jump-subroutine instruction (JSR) of a network; the loader (binder) makes JSR useful, and the loader itself uses JSR to accomplish its task. Likewise, the network makes RPC useful, enabling RPC to accomplish this task.

The RPC protocol provides the fields necessary for a client to identify itself to a service and vice-versa. Security and access control mechanisms can be built on top of the message authentication. Several different authentication protocols can be supported. A field in the RPC header specifies the protocol being used. More information on authentication protocols can be found in the section “Record-Marking Standard” on page 232.

Program and Procedure Numbers

The RPC call message has three unsigned fields that uniquely identify the procedure to be called:

- remote program number
- remote program version number
- remote procedure number

Program numbers are administered by a central authority, as described in “Program Number Registration” on page 228.

The first implementation of a program will most likely have version number 1. Because most new protocols evolve into better, stable, and mature protocols, a version field of the call message identifies the version of the protocol the caller is using. Version numbers make “speaking” old and new protocols through the same server process possible.

The procedure number identifies the procedure to be called. These numbers are documented in the individual program’s protocol specification. For example, a file service’s protocol specification may state that its procedure number 5 is “read” and procedure number 12 is “write.”

Just as remote program protocols may change over several versions, the RPC message protocol itself may change. Therefore, the call message also has in it the RPC version number, which is always equal to 2 for the version of RPC described here.

The reply message to a request message has enough information to distinguish the following error conditions:

- The remote implementation of RPC does not “speak” protocol version 2. The lowest and highest supported RPC version numbers are returned.
- The remote program is not available on the remote system.
- The remote program does not support the requested version number. The lowest and highest supported remote program version numbers are returned.
- The requested procedure number does not exist. (This is usually a caller-side protocol or programming error.)
- The parameters to the remote procedure appear to be garbage from the server’s point of view. (Again, this is usually caused by a disagreement about the protocol between client and service.)

Provisions for authentication of caller to service and vice versa are provided as a part of the RPC protocol. The call message has two authentication fields, the credentials and verifier. The reply message has one authentication field, the response verifier. The RPC protocol specification defines all three fields to be the following opaque type:

```
enum auth_flavor {  
    AUTH_NONE = 0,
```

```

AUTH_SYS = 1,
AUTH_SHORT = 2,
AUTH_DES = 3,
AUTH_KERB = 4
/* and more to be defined */
};
struct opaque_auth {
enum      auth_flavor;      /* style of credentials */
caddr_t   oa_base;         /* address of more auth stuff */
u_int     oa_length;       /* not to exceed MAX_AUTH_BYTES */
};

```

An `opaque_auth` structure is an `auth_flavor` enumeration followed by bytes that are opaque to the RPC protocol implementation.

The interpretation and semantics of the data contained within the authentication fields are specified by individual, independent authentication protocol specifications. (See “Record-Marking Standard” on page 232 for definitions of the various authentication protocols.)

If authentication parameters are rejected, the response message contains information stating why they are rejected.

Program Number Assignment

Program numbers are distributed in groups of `0x20000000`, as shown in Table B-1.

TABLE B-1 RPC Program Number Assignment

Program Numbers	Description
00000000 - 1fffffff	Defined by host
20000000 - 3fffffff	Defined by user
40000000 - 5fffffff	Transient (Reserved for customer-written applications)
60000000 - 7fffffff	Reserved
80000000 - 9fffffff	Reserved
a0000000 - bfffffff	Reserved
c0000000 - dfffffff	Reserved
e0000000 - ffffffff	Reserved

Sun Microsystems administers the first group of numbers, which should be identical for all customers. If a customer develops an application that might be of general interest, that application should be given an assigned number in the first range.

The second group of numbers is reserved for specific customer applications. This range is intended primarily for debugging new programs.

The third group is reserved for applications that generate program numbers dynamically.

The final groups are reserved for future use, and should not be used.

Program Number Registration

To register a protocol specification, send a request by email to `rpc@sun.com`, or write to: RPC Administrator Sun Microsystems 901 San Antonio Road Palo Alto, CA 94043

Please include a compilable `rpcgen ``.x``` file describing your protocol. You will be given a unique program number in return.

The RPC program numbers and protocol specifications of standard RPC services can be found in the include files in `/usr/include/rpcsvc`. These services, however, constitute only a small subset of those that have been registered.

Other Uses of the RPC Protocol

The intended use of this protocol is for calling remote procedures. That is, each call message is matched with a response message. However, the protocol itself is a message-passing protocol with which other (non-RPC) protocols can be implemented. Some of the non-RPC protocols supported by the RPC package are batching and broadcasting.

Batching

Batching allows a client to send an arbitrarily large sequence of call messages to a server; batching typically uses reliable byte stream protocols (like TCP) for its transport. In batching, the client never waits for a reply from the server, and the server does not send replies to batch requests. A sequence of batch calls is usually finished by a non-batch RPC call to flush the pipeline (with positive acknowledgment). For more information, see “Batching” on page 108.

Broadcast RPC

In broadcast RPC, the client sends a broadcast packet to the network and waits for numerous replies. Broadcast RPC uses connectionless, packet-based protocols (like

UDP) as its transports. Servers that support broadcast protocols only respond when the request is successfully processed, and are silent in the face of errors. Broadcast RPC uses the `rpcbind` service to achieve its semantics. See “Broadcast RPC” on page 106 and “`rpcbind` Protocol” on page 251 for further information.

The RPC Message Protocol

This section defines the RPC message protocol in the XDR data description language. The message is defined in a top-down style, as shown in Code Example B-1.

CODE EXAMPLE B-1 RPC Message Protocol

```
enum msg_type {
    CALL = 0,
    REPLY = 1
};

/*
 * A reply to a call message can take on two forms: The message was
 * either accepted or rejected.
 */
enum reply_stat {
    MSG_ACCEPTED = 0,
    MSG_DENIED = 1
};

/*
 * Given that a call message was accepted, the following is the
 * status of an attempt to call a remote procedure.
 */
enum accept_stat {
    SUCCESS = 0,          /* RPC executed successfully */
    PROG_UNAVAIL = 1,    /* remote service hasn't exported prog */
    PROG_MISMATCH = 2,  /* remote service can't support versn # */
    PROC_UNAVAIL = 3,   /* program can't support proc */
    GARBAGE_ARGS = 4   /* procedure can't decode params */
};

/*
 * Reasons a call message was rejected:
 */
enum reject_stat {
    RPC_MISMATCH = 0, /* RPC version number != 2 */
    AUTH_ERROR = 1   /* remote can't authenticate caller */
};

/*
 * Why authentication failed:
 */
enum auth_stat {
    AUTH_BADCRED = 1,      /* bad credentials */
    AUTH_REJECTEDCRED = 2, /* clnt must do new session */
    AUTH_BADVERF = 3,     /* bad verifier */
};
```

(continued)

(Continuation)

```
    AUTH_REJECTEDVERF = 4, /* verfif expired or replayed */
    AUTH_TOOWEAK = 5      /* rejected for security */
};

/*
 * The RPC message:
 * All messages start with a transaction identifier, xid, followed
 * by a two-armed discriminated union. The union's discriminant is
 * a msg_type which switches to one of the two types of the
 * message.
 * The xid of a REPLY message always matches that of the
 * initiating CALL message. NB: The xid field is only used for
 * clients matching reply messages with call messages or for servers
 * detecting retransmissions; the service side cannot treat this id as
 * any type of sequence number.
 */
struct rpc_msg {
    unsigned int xid;
    union switch (msg_type mtype) {
        case CALL:
            call_body cbody;
        case REPLY:
            reply_body rbody;
    } body;
};

/*
 * Body of an RPC request call:
 * In version 2 of the RPC protocol specification, rpcvers must be
 * equal to 2. The fields prog, vers, and proc specify the remote
 * program, its version number, and the procedure within the
 * remote program to be called. After these fields are two
 * authentication parameters: cred (authentication credentials) and
 * verf (authentication verifier). The two authentication parameters
 * are followed by the parameters to the remote procedure, which are
 * specified by the specific program protocol.
 */
struct call_body {
    unsigned int rpcvers; /* must be equal to two (2) */
    unsigned int prog;
    unsigned int vers;
    unsigned int proc;
    opaque_auth cred;
    opaque_auth verf;
    /* procedure specific parameters start here */
};

/*
 * Body of a reply to an RPC request:
 * The call message was either accepted or rejected.
 */
union reply_body switch (reply_stat stat) {
    case MSG_ACCEPTED:
        accepted_reply areply;
};
```

(continued)

```

    case MSG_DENIED:
        rejected_reply rreply;
    } reply;

/*
 * Reply to an RPC request that was accepted by the server: there
 * could be an error even though the request was accepted. The
 * first field is an authentication verifier that the server
 * generates in order to validate itself to the caller. It is
 * followed by a union whose discriminant is an enum accept_stat.
 * The SUCCESS arm of the union is protocol specific.
 * The PROG_UNAVAIL, PROC_UNAVAIL, and GARBAGE_ARGP arms of
 * the union are void. The PROG_MISMATCH arm specifies the lowest
 * and highest version numbers of the remote program supported by
 * the server.
 */
struct accepted_reply {
    opaque_auth verf;
    union switch (accept_stat stat) {
        case SUCCESS:
            opaque results[0];
            /* procedure-specific results start here */
        case PROG_MISMATCH:
            struct {
                unsigned int low;
                unsigned int high;
            } mismatch_info;
        default:
            /*
             * Void. Cases include PROG_UNAVAIL, PROC_UNAVAIL, and
             * GARBAGE_ARGS.
             */
            void;
    } reply_data;
};

/*
 * Reply to an RPC request that was rejected by the server:
 * The request can be rejected for two reasons: either the server
 * is not running a compatible version of the RPC protocol
 * (RPC_MISMATCH), or the server refuses to authenticate the
 * caller AUTH_ERROR). In case of an RPC version mismatch,
 * the server returns the lowest and highest supported RPC
 * version numbers. In case of refused authentication, failure
 * status is returned.
 */
union rejected_reply switch (reject_stat stat) {
    case RPC_MISMATCH:
        struct {
            unsigned int low;
            unsigned int high;
        } mismatch_info;
};

```

(continued)

(Continuation)

```
case AUTH_ERROR:
    auth_stat stat;
};
```

Record-Marking Standard

When RPC messages are passed on top of a byte stream transport (like TCP), it is necessary, or at least desirable, to delimit one message from another to detect and possibly recover from user protocol errors. This is called record marking (RM). One RPC message fits into one RM record.

A record is composed of one or more record fragments. A record fragment is a four-byte header followed by 0 to $(2^{31}) - 1$ bytes of fragment data. The bytes encode an unsigned binary number; as with XDR integers, the byte order is the network byte order.

The header encodes two values:

- A Boolean that specifies whether the fragment is the last fragment of the record (bit value 1 implies the fragment is the last fragment).
- A 31-bit unsigned binary value that is the length in bytes of the fragment's data. The Boolean value is the highest-order bit of the header; the length is the 31 low-order bits. (This record specification is not in XDR standard form).

Authentication Protocols

Authentication parameters are opaque but open-ended to the rest of the RPC protocol. This section defines some flavors of authentication that have already been implemented. Other sites are free to invent new authentication types, with the same rules of flavor number assignment for program number assignment. Sun Microsystems maintains and administers a range of authentication flavors. To have authentication numbers (like RPC program numbers) allocated (or registered to them), contact the Sun RPC Administrator, as described in “Program Number Registration” on page 228.

AUTH_NONE

Calls are often made where the caller does not authenticate itself and the server disregards who the caller is. In these cases, the *flavor* value (the “discriminant” of the `opaque_auth` “union”) of the RPC message’s credentials, verifier, and response verifier is `AUTH_NONE`. The body length is zero when `AUTH_NONE` authentication flavor is used.

AUTH_SYS

This is the same as the authentication flavor previously known as `AUTH_UNIX`. The caller of a remote procedure may wish to identify itself using traditional UNIX process permissions authentication. The *flavor* of the `opaque_auth` of such an RPC call message is `AUTH_SYS`. The bytes of the body encode the following structure:

```
struct auth_sysparms {
    unsigned int stamp;
    string machinename<255>;
    uid_t uid;
    gid_t gid;
    gid_t gids<10>;
};
```

- *stamp* is an arbitrary ID that the caller machine may generate.
- *machinename* is the name of the caller’s machine.
- *uid* is the caller’s effective user ID.
- *gid* is the caller’s effective group ID.
- *gids* is a counted array of groups in which the caller is a member.

The *flavor* of the verifier accompanying the credentials should be `AUTH_NONE`.

The AUTH_SHORT Verifier

When using `AUTH_SYS` authentication, the *flavor* of the response verifier received in the reply message from the server may be `AUTH_NONE` or `AUTH_SHORT`.

If `AUTH_SHORT`, the bytes of the response verifier’s string encode a `short_hand_verf` structure. This opaque structure may now be passed to the server instead of the original `AUTH_SYS` credentials.

The server keeps a cache that maps shorthand opaque structures (passed back by way of an `AUTH_SHORT` style response verifier) to the original credentials of the caller. The caller can save network bandwidth and server cpu cycles by using the new credentials.

The server may flush the shorthand opaque structure at any time. If this happens, the remote procedure call message will be rejected owing to an authentication error.

The reason for the failure will be `AUTH_REJECTEDCRED`. At this point, the caller may wish to try the original `AUTH_SYS` style of credentials. See Figure B-1.

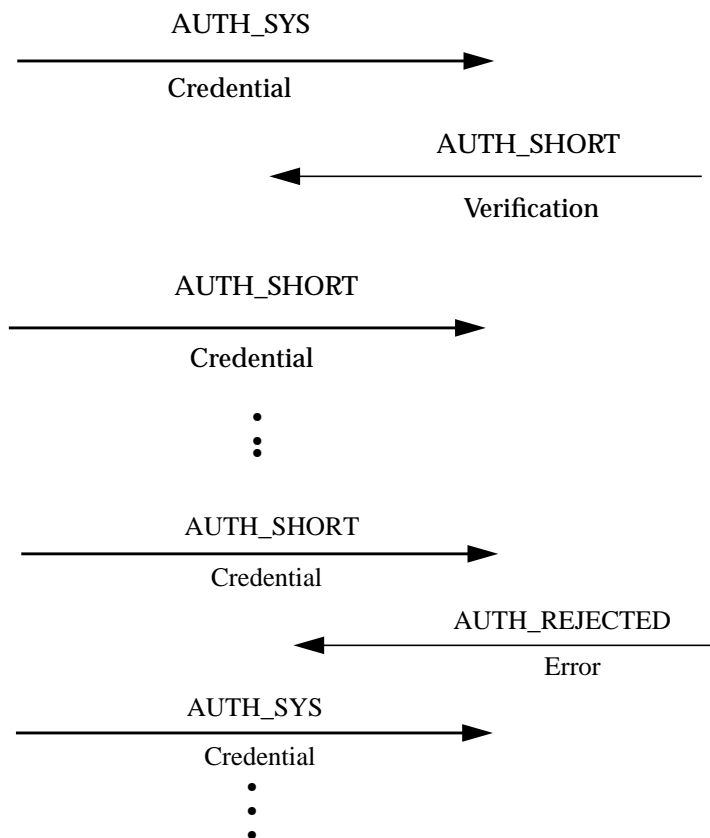

Figure B-1 Authentication Process Map

AUTH_DES Authentication

`AUTH_SYS` authentication has the following problems:

1. Caller identification cannot be guaranteed to be unique if machines with differing operating systems are on the same network.
2. There is no verifier, so credentials can easily be faked. `AUTH_DES` authentication attempts to fix these two problems.

The first problem is handled by addressing the caller by a simple string of characters instead of by an operating system specific integer. This string of characters is known as the netname or network name of the caller. The server should not interpret the

caller's name in any way other than as the identity of the caller. Thus, netnames should be unique for every caller in the naming domain.

It is up to each operating system's implementation of `AUTH_DES` authentication to generate netnames for its users that ensure this uniqueness when they call remote servers. Operating systems already distinguish users local to their systems. It is usually a simple matter to extend this mechanism to the network. For example, a user with a user ID of 515 might be assigned the following netname:

`''UNIX.515@sun.com''`. This netname contains three items that serve to ensure it is unique. Going backward, there is only one naming domain called `sun.com` in the Internet. Within this domain, there is only one `UNIX` user with user ID 515. However, there may be another user on another operating system, for example `VMS`, within the same naming domain who, by coincidence, happens to have the same user ID. To ensure that these two users can be distinguished you add the operating system name. So one user is `''UNIX.515@sun.com''` and the other is `''VMS.515@sun.com''`.

The first field is actually a naming method rather than an operating system name. It just happens that there is almost a one-to-one correspondence between naming methods and operating systems. If the world could agree on a naming standard, the first field could be a name from that standard, instead of an operating system name.

AUTH_DES Authentication Verifiers

Unlike `AUTH_SYS` authentication, `AUTH_DES` authentication does have a verifier so the server can validate the client's credential (and vice versa). The contents of this verifier are primarily an encrypted timestamp. The server can decrypt this timestamp, and if it is close to its current real time, then the client must have encrypted it correctly. The only way the client could encrypt it correctly is to know the conversation key of the RPC session. If the client knows the conversation key, it must be the real client.

The conversation key is a DES [5] key that the client generates and notifies the server of in its first RPC call. The conversation key is encrypted using a public key scheme in this first transaction. The particular public key scheme used in `AUTH_DES` authentication is Diffie-Hellman [3] with 192-bit keys. The details of this encryption method are described later.

The client and the server need the same notion of the current time for this to work. If network time synchronization cannot be guaranteed, then client can synchronize with the server before beginning the conversation. `rpcbind` provides a procedure, `RPCBPROC_GETTIME`, which may be used to obtain the current time.

A server can determine if a client timestamp is valid. For any transaction after the first, the server checks for two things:

- The timestamp is greater than the one previously seen from the same client.
- The timestamp has not expired. A timestamp is expired if the server's time is later than the sum of the client's timestamp plus what is known as the client's window.

The window is a number the client passes (encrypted) to the server in its first transaction. The window can be thought of as a lifetime for the credential.

For the first transaction, the server checks that the timestamp has not expired. As an added check, the client sends an encrypted item in the first transaction known as the window verifier which must be equal to the window minus 1, or the server will reject the credential.

The client must check the verifier returned from the server to be sure it is legitimate. The server sends back to the client the encrypted timestamp it received from the client, minus one second. If the client gets anything other than this, it will reject it.

Nicknames and Clock Synchronization

After the first transaction, the server's `AUTH_DES` authentication subsystem returns in its verifier to the client an integer nickname that the client may use in its further transactions instead of passing its netname, encrypted DES key and window every time. The nickname is most likely an index into a table on the server that stores for each client its netname, decrypted DES key and window. It should however be treated as opaque data by the client.

Though originally synchronized, client and server clocks can get out of sync. If this happens, the client RPC subsystem most likely will receive an `RPC_AUTHERROR` at which point it should resynchronize.

A client may still get the `RPC_AUTHERROR` error even though it is synchronized with the server. The reason is that the server's nickname table is a limited size, and it may flush entries whenever it wants. The client should resend its original credential and the server will give it a new nickname. If a server crashes, the entire nickname table will be flushed, and all clients will have to resend their original credentials.

DES Authentication Protocol (in XDR language)

CODE EXAMPLE B-2 AUTH_DES Authentication Protocol

```
/*
 * There are two kinds of credentials: one in which the client
 * uses its full network name, and one in which it uses its
 * ``nickname`` (just an unsigned integer) given to it by the
 * server. The client must use its full name in its first
 * transaction with the server, in which the server will return
 * to the client its nickname. The client may use its nickname
 * in all further transactions with the server. There is no
 * requirement to use the nickname, but it is wise to use it for
 * performance reasons.
 */
```

(continued)

```

enum authdes_namekind {
    ADN_FULLNAME = 0,
    ADN_NICKNAME = 1
};

/*
 * A 64-bit block of encrypted DES data
 */
typedef opaque des_block[8];

/*
 * Maximum length of a network user's name
 */
const MAXNETNAMELEN = 255;

/*
 * A fullname contains the network name of the client, an
 * encrypted conversation key and the window. The window
 * is actually a lifetime for the credential. If the time
 * indicated in the verifier timestamp plus the window has
 * passed, then the server should expire the request and
 * not grant it. To insure that requests are not replayed,
 * the server should insist that timestamps be greater
 * than the previous one seen, unless it is the first transaction.
 * In the first transaction, the server checks instead that the
 * window verifier is one less than the window.
 */
struct authdes_fullname {
    string name<MAXNETNAMELEN>; /* name of client */
    des_block key; /* PK encrypted conversation key */
    unsigned int window; /* encrypted window */
}; /* NOTE: PK means "public key" */

/*
 * A credential is either a fullname or a nickname
 */
union authdes_credswitch(authdes_namekindadc_namekind){
    case ADN_FULLNAME:
        authdes_fullname adc_fullname;
    case ADN_NICKNAME:
        unsigned int adc_nickname;
};

/*
 * A timestamp encodes the time since midnight, January 1, 1970.
 */
struct timestamp {
    unsigned int seconds; /* seconds */
    unsigned int useconds; /* and microseconds */
};

/*
 * Verifier: client variety

```

(continued)

(Continuation)

```
*/
struct authdes_verf_clnt {
    timestamp adv_timestamp; /* encrypted timestamp */
    unsigned int adv_winverf; /* encrypted window verifier */
};

/*
 * Verifier: server variety
 * The server returns (encrypted) the same timestamp the client gave
 * it minus one second. It also tells the client its nickname to be
 * used in future transactions (unencrypted).
 */
struct authdes_verf_svr {
    timestamp adv_timeverf; /* encrypted verifier */
    unsigned int adv_nickname; /* new nickname for clnt */
};
```

Diffie-Hellman Encryption

In this scheme, there are two constants, `PROOT` and `HEXMODULUS`. The particular values chosen for these for the DES authentication protocol are:

```
const PROOT = 3;
const HEXMODULUS = /* hex */
    "d4a0ba0250b6fd2ec626e7efd637df76c716e22d0944b88b";
```

The way this scheme works is best explained by an example. Suppose there are two people "A" and "B" who want to send encrypted messages to each other. A and B each generate a random secret key that they do not disclose to anyone. Let these keys be represented as `SK(A)` and `SK(B)`. They also publish in a public directory their public keys. These keys are computed as follows:

```
PK(A) = (PROOT ** SK(A)) mod HEXMODULUS
PK(B) = (PROOT ** SK(B)) mod HEXMODULUS
```

The `**` notation is used here to represent exponentiation.

Now, both A and B can arrive at the common key between them, represented here as `CK(A, B)`, without disclosing their secret keys.

A computes:

```
CK(A, B) = (PK(B) ** SK(A)) mod HEXMODULUS
```

while B computes:

```
CK(A, B) = (PK(A) ** SK(B)) mod HEXMODULUS
```

These two can be shown to be equivalent: $(PK(B) ** SK(A)) \bmod \text{HEXMODULUS} = (PK(A) ** SK(B)) \bmod \text{HEXMODULUS}$. Drop the $\bmod \text{HEXMODULUS}$ parts and assume modulo arithmetic to simplify the process:

$$PK(B) ** SK(A) = PK(A) ** SK(B)$$

Then replace $PK(B)$ by what B computed earlier and likewise for $PK(A)$.

$$((\text{PROOT} ** SK(B)) ** SK(A)) = (\text{PROOT} ** SK(A)) ** SK(B)$$

which leads to:

$$\text{PROOT} ** (SK(A) * SK(B)) = \text{PROOT} ** (SK(A) * SK(B))$$

This common key $CK(A, B)$ is not used to encrypt the timestamps used in the protocol. It is used only to encrypt a conversation key that is then used to encrypt the timestamps. The reason for doing this is to use the common key as little as possible, for fear that it could be broken. Breaking the conversation key is a far less serious offense, because conversations are comparatively short-lived.

The conversation key is encrypted using 56-bit DES keys, yet the common key is 192 bits. To reduce the number of bits, 56 bits are selected from the common key as follows. The middle-most 8 bytes are selected from the common key, and then parity is added to the lower order bit of each byte, producing a 56-bit key with 8 bits of parity.

AUTH_KERB Authentication

To avoid compiling Kerberos code into the operating system kernel, the kernel used in the S implementation of AUTH_KERB uses a proxy RPC daemon called `kerbd`. The daemon exports three procedures. Refer to the `kerbd(1M)` manpage for more details.

1. `KGETKCRED` is used by the server-side RPC to check the authenticator presented by the client.
2. `KSETKCRED` returns the encrypted ticket and DES session key, given a primary name, instance, and realm.
3. `KGETUCRED` is UNIX-specific. It returns the user's ID, the group ID, and groups list, assuming that the primary name is mapped to a user name known to the server.

The best way to describe how Kerberos works is to use an example based on a service currently implementing Kerberos: the network file system (NFS). The NFS service on server s is assumed to have the well-known principal name `nfs.s`. A privileged user on client c is assumed to have the primary name `root` and an instance c . Note that (unlike `AUTH_DES`) when the user's ticket-granting ticket has expired, `kinit()` must be reinvoked. NFS service for Kerberos mounts will fail until a new ticket-granting ticket is obtained.

NFS Mount Example

This section follows an NFS mount request from start to finish using `AUTH_KERB`. Since mount requests are executed as root, the user's identity is `root.c`.

Client *c* makes a `MOUNTPROC_MOUNT` request to the server *s* to obtain the file handle for the directory to be mounted. The client mount program makes an NFS mount system call, handing the client kernel the file handle, mount flavor, time synchronization address, and the server's well-known name, `nfs.s`. Next the client kernel contacts the server at the time synchronization host to obtain the client-server time bias.

The client kernel makes the following RPC calls: (1) `KSETKCREDS` to the local `kerbd` to obtain the ticket and session key, (2) `NFSPROC_GETATTR` to the server's NFS service, using the full name credential and verifier. The server receives the calls and makes the `KGETKCREDS` call to its local `kerbd` to check the client's ticket.

The server's `kerbd` and the Kerberos library decrypt the ticket and return, among other data, the principal name and DES session key. The server checks that the ticket is still valid, uses the session key to decrypt the DES-encrypted portions of the credential and verifier, and checks that the verifier is valid.

The possible Kerberos authentication errors returned at this time are:

- `AUTH_BADCRED` is returned if the verifier is invalid (the decrypted *win* in the credential and *win +1* in the verifier do not match), or the timestamp is not within the window range
- `AUTH_REJECTEDCRED` is returned if a replay is detected
- `AUTH_BADVERF` is returned if the verifier is garbled

If no errors are received, the server caches the client's identity and allocates a nickname (small integer) to be returned in the NFS reply. The server then checks if the client is in the same realm as the server. If it is, the server calls `KGETUCRED` to its local `kerbd` to translate the principal's primary name into UNIX credentials. If it is not translatable, the user is marked anonymous. The server checks these credentials against the file system's export information. There are three cases to consider:

1. If the `KGETUCRED` call fails and anonymous requests are allowed, the UNIX credentials of the anonymous user are assigned.
2. If the `KGETUCRED` call fails and anonymous requests are not allowed, the NFS call fails with the `AUTH_TOOWEAK`.
3. If the `KGETUCRED` call succeeds, the credentials are assigned, and normal protection checking follows, including checking for root permission.

Next the server sends an NFS reply, including the nickname and server's verifier. The client receives the reply, decrypts and validates the verifier, and stores the nickname for future calls. The client makes a second NFS call to the server, and the calls to the server described earlier are repeated. The client kernel makes an `NFSPROC_STATVFS` call to the server's NFS service, using the nickname credential and verifier described previously. The server receives the call and validates the nickname. If it is out of

range, the error `AUTH_BADCRED` is returned. The server uses the session key just obtained to decrypt the DES-encrypted portions of the verifier and validates the verifier.

The possible Kerberos authentication errors returned at this time are:

- `AUTH_REJECTEDVERF` is returned if the timestamp is invalid, a replay is detected, or if the timestamp is not within the window range
- `AUTH_TIMEEXPIRE` is returned if the service ticket is expired

If no errors are received, the server uses the nickname to retrieve the caller's UNIX credentials. Then it checks these credentials against the file system's export information, and sends an NFS reply that includes the nickname and the server's verifier. The client receives the reply, decrypts and validates the verifier, and stores the nickname for future calls. Last, the client's NFS mount system call returns, and the request is finished.

KERB Authentication Protocol (in XDR Language)

Code Example B-3 (`AUTH_KERB`) has many similarities to the one for `AUTH_DES`, shown in Code Example B-2. Note the differences.

CODE EXAMPLE B-3 AUTH_KERB Authentication Protocol

```
#define AUTH_KERB 4
/*
 * There are two kinds of credentials: one in which the client
 * sends the (previously encrypted) Kerberos ticket, and one in
 * which it uses its ``nickname'' (just an unsigned integer)
 * given to it by the server. The client must use its full name
 * in its first transaction with the server, in which the server
 * will return to the client its nickname. The client may use
 * its nickname in all further transactions with the server
 * (until the ticket expires). There is no requirement to use
 * the nickname, but it is wise to use it for performance reasons.
 */
enum authkerb_namekind {
    AKN_FULLNAME = 0,
    AKN_NICKNAME = 1
};

/*
 * A fullname contains the encrypted service ticket and the
 * window. The window is actually a lifetime
 * for the credential. If the time indicated in the verifier
 * timestamp plus the window has passed, then the server should
 * expire the request and not grant it. To insure that requests
 * are not replayed, the server should insist that timestamps be
 * greater than the previous one seen, unless it is the first
 * transaction. In the first transaction, the server checks
 * instead that the window verifier is one less than the window.
```

(continued)

(Continuation)

```
*/
struct authkerb_fullname {
    KTEXT_ST ticket;          /* Kerberos service ticket */
    unsigned long window;    /* encrypted window */
};
/*
 * A credential is either a fullname or a nickname
 */
union authkerb_credswitch(authkerb_namekind akc_namekind){
    case AKN_FULLNAME:
        authkerb_fullname akc_fullname;
    case AKN_NICKNAME:
        unsigned long akc_nickname;
};

/*
 * A timestamp encodes the time since midnight, January 1, 1970.
 */
struct timestamp {
    unsigned long seconds;    /* seconds */
    unsigned long useconds;  /* and microseconds */
};

/*
 * Verifier: client variety
 */
struct authkerb_verf_clnt {
    timestamp akv_timestamp; /* encrypted timestamp */
    unsigned long akv_winverf; /* encrypted window verifier */
};

/*
 * Verifier: server variety
 * The server returns (encrypted) the same timestamp the client
 * gave it minus one second. It also tells the client its
 * nickname to be used in future transactions (unencrypted).
 */
struct authkerb_verf_svr {
    timestamp akv_timeverf; /* encrypted verifier */
    unsigned long akv_nickname; /* new nickname for clnt */
};
```

The RPC Language Specification

Just as there was a need to describe the XDR data types in a formal language, there is also need to describe the procedures that operate on these XDR data types in a formal language as well. The RPC Language, an extension to the XDR language, serves this purpose. The following example is used to describe the essence of the language.

An Example Service Described in the RPC Language

Code Example B-4 shows the specification of a simple ping program.

CODE EXAMPLE B-4 ping Service Using RPC Language

```
/*
 * Simple ping program
 */
program PING_PROG {
    version PING_VERS_PINGBACK {
        void
        PINGPROC_NULL(void) = 0;
        /*
         * ping the caller, return the round-trip time
         * in milliseconds. Return a minus one (-1) if
         * operation times-out
         */
        int
        PINGPROC_PINGBACK(void) = 1;
        /* void - above is an argument to the call */
    } = 2;
}
/*
 * Original version
 */
version PING_VERS_ORIG {
    void
    PINGPROC_NULL(void) = 0;
} = 1;
} = 200000;
const PING_VERS = 2; /* latest version */
```

The first version described is PING_VERS_PINGBACK with two procedures, PINGPROC_NULL and PINGPROC_PINGBACK.

PINGPROC_NULL takes no arguments and returns no results, but it is useful for such things as computing round-trip times from the client to the server and back again. By convention, procedure 0 of any RPC program should have the same semantics, and never require authentication.

The second procedure returns the amount of time (in microseconds) that the operation used.

The next version, PING_VERS_ORIG, is the original version of the protocol and it does not contain PINGPROC_PINGBACK procedure. It is useful for compatibility with old client programs, and as this program matures it may be dropped from the protocol entirely.

RPCL Syntax

The RPC language (RPCL) is similar to C. This section describes the syntax of the RPC language, showing a few examples along the way. It also shows how RPC and XDR type definitions get compiled into C type definitions in the output header file.

An RPC language file consists of a series of definitions.

```
definition-list:
    definition;
definition: definition-list
```

It recognizes six types of definitions.

```
definition:
    enum-definition
    const-definition
    typedef-definition
    struct-definition
    union-definition
    program-definition
```

Definitions are not the same as declarations. No space is allocated by a definition – only the type definition of a single or series of data elements. This means that variables still must be declared.

The RPC language is identical to the XDR language, except for the added definitions described in Table B-2.

TABLE B-2 RPC Language Definitions

Term	Definition
program-definition	program program-ident {version-list} = value
version-list	version; version; version-list
version	version version-ident {procedure-list} = value
procedure-list	procedure; procedure; procedure-list
procedure	type-ident procedure-ident (type-ident) = value

- The following keywords are added and cannot be used as identifiers: program version.
- Neither version name nor a version number can occur more than once within the scope of a program definition.
- Neither a procedure name nor a procedure number can occur more than once within the scope of a version definition.
- Program identifiers are in the same name space as constant and type identifiers.
- Only unsigned constants can be assigned to programs, versions, and procedures.

Enumerations

RPC/XDR enumerations have the same syntax as C enumerations.

```
enum-definition:
    "enum" enum-ident "{"
        enum-value-list
    "}"
enum-value-list:
    enum-value
    enum-value "," enum-value-list
enum-value:
    enum-value-ident
    enum-value-ident "=" value
```

Here is an example of an XDR enum and the C enum to which it gets compiled.

```
enum colortype {
    RED = 0,
    GREEN = 1,
    BLUE = 2
};
-->
enum colortype {
    RED = 0,
    GREEN = 1,
    BLUE = 2,
};
typedef enum colortype colortype;
```

Constants

XDR symbolic constants may be used wherever an integer constant is used. For example, in array size specifications:

```
const-definition:
const const-ident = integer
```

The following example defines a constant, DOZEN as equal to 12:

```
const DOZEN = 12; --> #define DOZEN 12
```

Type Definitions

XDR typedefs have the same syntax as C typedefs.

```
typedef-definition:
typedef declaration
```

This example defines an `fname_type` used for declaring file name strings that have a maximum length of 255 characters.

```
typedef string fname_type<255>; --> typedef char *fname_type;
```

Declarations

In XDR, there are four kinds of declarations. These declarations must be a part of a struct or a typedef; they cannot stand alone:

```
declaration:
    simple-declaration
    fixed-array-declaration
    variable-array-declaration
    pointer-declaration
```

Simple Declarations

Simple declarations are just like simple C declarations:

```
simple-declaration:
    type-ident variable-ident
```

Example:

```
colortype color; --> colortype color;
```

Fixed-Length Array Declarations

Fixed-length array declarations are just like C array declarations:

```
fixed-array-declaration:
    type-ident variable-ident [value]
```

Example:

```
colortype palette[8]; --> colortype palette[8];
```

Many programmers confuse variable declarations with type declarations. It is important to note that `rpcgen` does not support variable declarations. This example is a program that will not compile:

```
int data[10];
program P {
    version V {
        int PROC(data) = 1;
    } = 1;
} = 0x200000;
```

The example above will not compile because of the variable declaration:

```
int data[10]
```

Instead, use:

```
typedef int data[10];
```

or

```
struct data {int dummy [10]};
```

Variable-Length Array Declarations

Variable-length array declarations have no explicit syntax in C. The XDR language does have a syntax, using angle brackets:

```
variable-array-declaration:
    type-ident variable-ident <value>
    type-ident variable-ident < >
```

The maximum size is specified between the angle brackets. The size may be omitted, indicating that the array may be of any size:

```
int heights<12>; /* at most 12 items */
int widths<>; /* any number of items */
```

Because variable-length arrays have no explicit syntax in C, these declarations are compiled into `struct` declarations. For example, the `heights` declaration compiled into the following `struct`:

```

struct {
    u_int heights_len;           /* # of items in array */
    int *heights_val;          /* pointer to array */
} heights;

```

The number of items in the array is stored in the *_len* component and the pointer to the array is stored in the *_val* component. The first part of each component name is the same as the name of the declared XDR variable (*heights*).

Pointer Declarations

Pointer declarations are made in XDR exactly as they are in C. Address pointers are not really sent over the network; instead, XDR pointers are useful for sending recursive data types such as lists and trees. The type is called “optional-data,” not “pointer,” in XDR language:

```

pointer-declaration:
    type-ident *variable-ident

```

Example:

```

listitem *next; --> listitem *next;

```

Structures

An RPC/XDR `struct` is declared almost exactly like its C counterpart. It looks like the following:

```

struct-definition:
    struct struct-ident "{"
        declaration-list
    "}"

declaration-list:
    declaration ";"
    declaration ";" declaration-list

```

The following XDR structure is an example of a two-dimensional coordinate and the C structure that it compiles into:

```

struct coord {
    int x;
    int y;
};
-->
struct coord {
    int x;
    int y;
};
typedef struct coord coord;

```

The output is identical to the input, except for the added `typedef` at the end of the output. This enables one to use `coord` instead of `struct coord` when declaring items.

Unions

XDR unions are discriminated unions, and do not look like C unions – they are more similar to Pascal variant records:

```
union-definition:
  "union" union-ident "switch" "("("simple declaration")" "{"
    case-list
  "}"
case-list:
  "case" value ":" declaration ";"
  "case" value ":" declaration ";" case-list
  "default" ":" declaration ";"
```

The following is an example of a type returned as the result of a “read data” operation: If there is no error, return a block of data; otherwise, don’t return anything.

```
union read_result switch (int errno) {
  case 0:
    opaque data[1024];
  default:
    void;
};
```

It compiles into the following:

```
struct read_result {
  int errno;
  union {
    char data[1024];
  } read_result_u;
};
typedef struct read_result read_result;
```

Notice that the union component of the output struct has the same name as the type name, except for the trailing `_u`.

Programs

RPC programs are declared using the following syntax:

```
program-definition:
  "program" program-ident "{"
    version-list
  "}" "=" value;
version-list:
  version ";"
  version ";" version-list
version:
  "version" version-ident "{"
    procedure-list
  "}" "=" value;
procedure-list:
  procedure ";"
  procedure ";" procedure-list
```

```
procedure:
    type-ident procedure-ident "(" type-ident ")" "=" value;
```

When the `-N` option is specified, `rpcgen` also recognizes the following syntax:

```
procedure:
    type-ident procedure-ident "(" type-ident-list ")" "=" value;
type-ident-list:
    type-ident
    type-ident "," type-ident-list
```

For example:

```
/*
 * time.x: Get or set the time. Time is represented as seconds
 * since 0:00, January 1, 1970.
 */
program TIMEPROG {
    version TIMEEVERS {
        unsigned int TIMEGET(void) = 1;
        void TIMESET(unsigned) = 2;
    } = 1;
} = 0x20000044;
```

Note that the `void` argument type means that no argument is passed.

This file compiles into these `#define` statements in the output header file:

```
#define TIMEPROG 0x20000044
#define TIMEEVERS 1
#define TIMEGET 1
#define TIMESET 2
```

Special Cases

There are several exceptions to the RPC language rules.

C-style Mode

In the new features section we talked about the features of the C-style mode of `rpcgen`. These features have implications with regard to the passing of `void` arguments. No arguments need be passed if their value is `void`.

Booleans

C has no built-in boolean type. However, the RPC library uses a boolean type called `bool_t` that is either `TRUE` or `FALSE`. Parameters declared as type `bool` in XDR language are compiled into `bool_t` in the output header file.

Example:

```
bool married; --> bool_t married;
```

Strings

The C language has no built-in string type, but instead uses the null-terminated `char *` convention. In C, strings are usually treated as null-terminated single-dimensional arrays.

In XDR language, strings are declared using the `string` keyword, and compiled into type `char *` in the output header file. The maximum size contained in the angle brackets specifies the maximum number of characters allowed in the strings (not counting the `NULL` character). The maximum size may be omitted, indicating a string of arbitrary length.

Examples:

```
string name<32>; --> char *name;
string longname<>; --> char *longname;
```

Note - `NULL` strings cannot be passed; however, a zero-length string (that is, just the terminator or `NULL` byte) can be passed.

Opaque Data

Opaque data is used in XDR to describe untyped data, that is, sequences of arbitrary bytes. It may be declared either as a fixed length or variable length array. Examples:

```
opaque diskblock[512]; --> char diskblock[512];
opaque filedata<1024>; --> struct {
    u_int filedata_len;
    char *filedata_val;
} filedata;
```

Voids

In a void declaration, the variable is not named. The declaration is just `void` and nothing else. Void declarations can only occur in two places: union definitions and program definitions (as the argument or result of a remote procedure, for example no arguments are passed.)

rpcbind Protocol

`rpcbind` maps RPC program and version numbers to universal addresses, thus making dynamic binding of remote programs possible.

`rpcbind` is bound to a well-known address of each supported transport, and other programs register their dynamically allocated transport addresses with it. `rpcbind` then makes those addresses publicly available. Universal addresses are string

representations of the transport-dependent address. They are defined by the addressing authority of the given transport.

rpcbind also aids in broadcast RPC. RPC programs will have different addresses on different machines, so there is no way to broadcast directly to all these programs. rpcbind, however, has a well-known address. So, to broadcast to a given program, the client actually sends its message to the rpcbind process on the machine it chooses to reach. rpcbind picks up the broadcast and calls the local service specified by the client. When rpcbind gets a reply from the local service, it passes the reply on to the client.)

CODE EXAMPLE B-5 rpcbind Protocol Specification (in RPC Language)

```
/*
 * rpcb_prot.x
 * RPCBIND protocol in rpc language
 */
/*
 * A mapping of (program, version, network ID) to universal
 address
 */
struct rpcb {
    rpcproc_t r_prog;          /* program number */
    rpcvers_t r_vers;        /* version number */
    string r_netid<>;        /* network id */
    string r_addr<>;         /* universal address */
    string r_owner<>;        /* owner of this service */ };
/* A list of mappings */
struct rpcblist {
    rpcb rpcb_map;
    struct rpcblist *rpcb_next;
};

/* Arguments of remote calls */
struct rpcb_rmtcallargs {
    rpcprog_t prog;          /* program number */
    rpcvers_t vers;         /* version number */
    rpcproc_t proc;         /* procedure number */
    opaque args<>;          /* argument */
};

/* Results of the remote call */
struct rpcb_rmtcallres {
    string addr<>;           /* remote universal address */
    opaque results<>;       /* result */
};

/*
 * rpcb_entry contains a merged address of a service on a
 particular
 * transport, plus associated netconfig information. A list of
 * rpcb_entries is returned by RPCBPROC_GETADRLIST. See
 netconfig.h
 * for values used in r_nc_* fields.
 */
```

(continued)

(Continuation)

```
*/
struct rpcb_entry {
    string      r_maddr<>;      /* merged address of service */
    string      r_nc_netid<>;   /* netid field */
    unsigned int r_nc_semantics; /* semantics of transport */
    string      r_nc_protofmly<>; /* protocol family */
    string      r_nc_proto<>;   /* protocol name */
};

/* A list of addresses supported by a service. */
struct rpcb_entry_list {
    rpcb_entry rpcb_entry_map;
    struct rpcb_entry_list *rpcb_entry_next;
};

typedef rpcb_entry_list *rpcb_entry_list_ptr;

/* rpcbind statistics */
const rpcb_highproc_2 = RPCBPROC_CALLIT;
const rpcb_highproc_3 = RPCBPROC_TADDR2UADDR;
const rpcb_highproc_4 = RPCBPROC_GETSTAT;
const RPCBSTAT_HIGHPROC = 13; /* # of procs in rpcbind V4 plus
one */
const RPCBVERS_STAT = 3; /* provide only for rpcbind V2, V3 and
V4 */
const RPCBVERS_4_STAT = 2;
const RPCBVERS_3_STAT = 1;
const RPCBVERS_2_STAT = 0;

/* Link list of all the stats about getport and getaddr */
struct rpcbs_addrlist {
    rpcprog_t prog;
    rpcvers_t vers;
    int success;
    int failure;
    string netid<>;
    struct rpcbs_addrlist *next;
};

/* Link list of all the stats about rmtcall */
struct rpcbs_rmtcalllist {
    rpcprog_t prog;
    rpcvers_t vers;
    rpcproc_t proc;
    int success;
    int failure;
    int indirect; /* whether callit or indirect */
    string netid<>;
    struct rpcbs_rmtcalllist *next;
};

typedef int rpcbs_proc[RPCBSTAT_HIGHPROC];
typedef struct rpcbs_addrlist *rpcbs_addrlist_ptr;
```

(continued)

(Continuation)

```
typedef rpcbs_rmtcalllist *rpcbs_rmtcalllist_ptr;

struct rpcb_stat {
    rpcbs_proc          info;
    int                 setinfo;
    int                 unsetinfo;
    rpcbs_addrlist_ptr addrinfo;
    rpcbs_rmtcalllist_ptr rmtinfo;
};

/*
 * One rpcb_stat structure is returned for each version of rpcbind
 * being monitored.
 */
typedef rpcb_stat rpcb_stat_byvers[RPCBVERS_STAT];
/* rpcbind procedures */
program RPCBPROG {
    version RPCBVERS {
        void
        RPCBPROC_NULL(void) = 0;

        /*
         * Registers the tuple [r_prog, r_vers, r_addr, r_owner,
         * r_netid]. The rpcbind server accepts requests for this
         * procedure on only the loopback transport for security
         * reasons. Returns TRUE if successful, FALSE on failure.
         */
        bool
        RPCBPROC_SET(rpcb) = 1;

        /*
         * Unregisters the tuple [r_prog, r_vers, r_owner, r_netid].

         * If vers is zero, all versions are unregistered. The rpcbind
         * server accepts requests for this procedure on only the
         * loopback transport for security reasons. Returns TRUE if
         * successful, FALSE on failure.
         */
        bool
        RPCBPROC_UNSET(rpcb) = 2;

        /*
         * Returns the universal address where the triple [r_prog,
         * r_vers, r_netid] is registered. If r_addr specified,
         * return a universal address merged on r_addr. Ignores
         * r_owner. Returns FALSE on failure.
         */
        string
        RPCBPROC_GETADDR(rpcb) = 3;

        /* Returns a list of all mappings. */
    };
};
```

(continued)

(Continuation)

```
rpcblist
RPCBPROC_DUMP(void) = 4;

/*
 * Calls the procedure on the remote machine.  If it is not
 *
 * registered, this procedure IS quiet; that is, it DOES NOT
 * return error information.
 */
rpcb_rmtcallres
RPCBPROC_CALLIT(rpcb_rmtcallargs) = 5;

/*
 * Returns the time on the rpcbind server's system.
 *
 */
unsigned int
RPCBPROC_GETTIME(void) = 6;

struct netbuf
RPCBPROC_UADDR2TADDR(string) = 7;

string
RPCBPROC_TADDR2UADDR(struct netbuf) = 8;

} = 3;
version RPCBVERS4 {
bool
RPCBPROC_SET(rpcb) = 1;

bool
RPCBPROC_UNSET(rpcb) = 2;

string
RPCBPROC_GETADDR(rpcb) = 3;

rpcblist_ptr
RPCBPROC_DUMP(void) = 4;

/*
 * NOTE: RPCBPROC_BCAST has the same functionality as CALLIT;
 *
 * the new name is intended to indicate that this procedure
 * should be used for broadcast RPC, and RPCBPROC_INDIRECT
 * should be used for indirect calls.
 */
rpcb_rmtcallres
RPCBPROC_BCAST(rpcb_rmtcallargs) = RPCBPROC_CALLIT;

unsigned int
RPCBPROC_GETTIME(void) = 6;
```

(continued)

(Continuation)

```
struct netbuf
RPCBPROC_UADDR2TADDR(string) = 7;

string
RPCBPROC_TADDR2UADDR(struct netbuf) = 8;

/*
 * Same as RPCBPROC_GETADDR except that if the given version
 *
 * number is not available, the address is not returned.
 */
string
RPCBPROC_GETVERSADDR(rpcb) = 9;

/*
 * Calls the procedure on the remote machine. If it is not
 * registered, this procedure IS NOT quiet; that is, it DOES
 * return error information.
 */
rpcb_rmtcallres
RPCBPROC_INDIRECT(rpcb_rmtcallargs) = 10;

/*
 * Same as RPCBPROC_GETADDR except that it returns a list of
 *
 * addresses registered for the combination (prog, vers).
 */
rpcb_entry_list_ptr
RPCBPROC_GETADDRLIST(rpcb) = 11;

/*
 * Returns statistics about the rpcbind server's activity.
 *
 */
rpcb_stat_byvers
RPCBPROC_GETSTAT(void) = 12;
} = 4;
} = 100000;
```

rpcbind Operation

rpcbind is contacted by way of an assigned address specific to the transport being used. For TCP/IP and UDP/IP, for example, it is port number 111. Each transport has such an assigned well known address. The following is a description of each of the procedures supported by rpcbind.

RPCBPROC_NULL

This procedure does no work. By convention, procedure zero of any program takes no parameters and returns no results.

RPCBPROC_SET

When a program first becomes available on a machine, it registers itself with the `rpcbind` program running on the same machine. The program passes its program number *prog*; version number *vers*; network identifier *netid*; and the universal address *uaddr*, on which it awaits service requests.

The procedure returns a Boolean response with the value `TRUE` if the procedure successfully established the mapping and `FALSE` otherwise. The procedure refuses to establish a mapping if one already exists for the ordered set (*prog*, *vers*, *netid*).

Note that neither *netid* nor *uaddr* can be `NULL`, and that *netid* should be a valid network identifier on the machine making the call.

RPCBPROC_UNSET

When a program becomes unavailable, it should unregister itself with the `rpcbind` program on the same machine.

The parameters and results have meanings identical to those of `RPCBPROC_SET`. The mapping of the (*prog*, *vers*, *netid*) tuple with *uaddr* is deleted.

If *netid* is `NULL`, all mappings specified by the ordered set (*prog*, *vers*, *) and the corresponding universal addresses are deleted. Only the owner of the service or the super-user is allowed to unset a service.

RPCBPROC_GETADDR

Given a program number *prog*, version number *vers*, and network identifier *netid*, this procedure returns the universal address on which the program is awaiting call requests.

The *netid* field of the argument is ignored and the *netid* is inferred from the *netid* of the transport on which the request came in.

RPCBPROC_DUMP

This procedure lists all entries in `rpcbind`'s database.

The procedure takes no parameters and returns a list of program, version, *netid*, and universal addresses. Call this procedure using a stream rather than a datagram transport to avoid the return of a large amount of data.

RPCBPROC_CALLIT

This procedure allows a caller to call another remote procedure on the same machine without knowing the remote procedure's universal address. It is intended for supporting broadcasts to arbitrary remote programs via `rpcbind`'s universal address.

The parameters *prog*, *vers*, *proc*, and the *args_ptr* are the program number, version number, procedure number, and parameters of the remote procedure.

Note - This procedure sends a response only if the procedure was successfully executed, and is silent (no response) otherwise.

The procedure returns the remote program's universal address, and the results of the remote procedure.

RPCBPROC_GETTIME

This procedure returns the local time on its own machine in seconds since midnight of January 1, 1970.

RPCBPROC_UADDR2TADDR

This procedure converts universal addresses to transport (`netbuf`) addresses. `RPCBPROC_UADDR2TADDR` is equivalent to `uaddr2taddr()`. See the `netdir(3NSL)` man page. Only processes that cannot link to the name-to-address library modules should use `RPCBPROC_UADDR2TADDR`.

RPCBPROC_TADDR2UADDR

This procedure converts transport (`netbuf`) addresses to universal addresses. `RPCBPROC_TADDR2UADDR` is equivalent to `taddr2uaddr()`. See the `netdir(3NSL)` man page. Only processes that can not link to the name-to-address library modules should use `RPCBPROC_TADDR2UADDR`.

Version 4 `rpcbind`

Version 4 of the `rpcbind` protocol includes all of the above procedures, and adds several others.

RPCBPROC_BCAST

This procedure is identical to the version 3 `RPCBPROC_CALLIT` procedure. The new name indicates that the procedure should be used for broadcast RPCs only. `RPCBPROC_INDIRECT`, defined in the following text, should be used for indirect RPC calls.

RPCBPROC_GETVERSADDR

This procedure is similar to `RPCBPROC_GETADDR`. The difference is the `r_vers` field of the `rpcb` structure can be used to specify the version of interest. If that version is not registered, no address is returned.

RPCBPROC_INDIRECT

This procedure is similar to `RPCBPROC_CALLIT`. Instead of being silent about errors (such as the program not being registered on the system), this procedure returns an indication of the error. This procedure should not be used for broadcast RPC. It is intended to be used with indirect RPC calls only.

RPCBPROC_GETADDRLIST

This procedure returns a list of addresses for the given `rpcb` entry. The client may be able use the results to determine alternate transports that it can use to communicate with the server.

RPCBPROC_GETSTAT

This procedure returns statistics on the activity of the `rpcbind` server. The information lists the number and kind of requests the server has received.

Note - All procedures except `RPCBPROC_SET` and `RPCBPROC_UNSET` can be called by clients running on a machine other than a machine on which `rpcbind` is running. `rpcbind` accepts only `RPCPROC_SET` and `RPCPROC_UNSET` requests on the loopback transport.

Bibliography

For further information on the technologies and architectures discussed in this appendix, reference the following resources.

1. Birrel, Andrew D. & Nelson, Bruce Jay; "Implementing Remote Procedure Calls," XEROX CSL-83-7, October 1983.
2. Cheriton, D.; "VMTP: Versatile Message Transaction Protocol," Preliminary Version 0.3; Stanford University, January 1987.
3. Diffie and Hellman; "New Directions in Cryptography," *IEEE Transactions on Information Theory* IT-22, November 1976.
4. Harrenstien, K.; "Time Server," *RFC 738*; Information Sciences Institute, October 1977.
5. National Bureau of Standards; "Data Encryption Standard," *Federal Information Processing Standards Publication 46*, January 1977.
6. Postel, J.; "Transmission Control Protocol - DARPA Internet Program Protocol Specification," *RFC 793*; Information Sciences Institute, September 1981.
7. Postel, J.; "User Datagram Protocol," *RFC 768*; Information Sciences Institute, August 1980.

XDR Protocol Specification

This appendix contains the XDR Protocol Language Specification.

- “XDR Protocol Introduction” on page 261
- “XDR Data Type Declarations” on page 262
- “The XDR Language Specification” on page 275

XDR Protocol Introduction

External data representation (XDR) is a standard for the description and encoding of data. The XDR protocol is useful for transferring data between different computer architectures and has been used to communicate data between very diverse machines. XDR fits into the ISO reference model’s presentation layer (layer 6) and is roughly analogous in purpose to X.409, ISO Abstract Syntax Notation. The major difference between the two is that XDR uses implicit typing, while X.409 uses explicit typing.

XDR uses a language to describe data formats and only can be used to describe data; it is not a programming language. This language makes it possible to describe intricate data formats in a concise manner. The XDR language is similar to the C language. Protocols such as RPC and the NFS use XDR to describe the format of their data.

The XDR standard assumes that bytes (or octets) are portable and that a byte is defined to be 8 bits of data.

Graphic Box Notation

This appendix uses graphic box notation for illustration and comparison. In most illustrations, each box depicts a byte. The representation of all items requires a multiple of four bytes (or 32 bits) of data. The bytes are numbered 0 through $n-1$. The bytes are read or written to some byte stream such that byte m always precedes byte $m+1$. The n bytes are followed by enough (0 to 3) residual zero bytes, r , to make the total byte count a multiple of four. Ellipses (. . .) between boxes show zero or more additional bytes where required. For example:

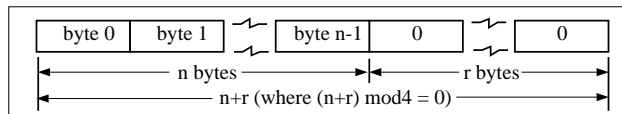

Basic Block Size

Choosing the XDR block size requires a trade off. Choosing a small size such as two makes the encoded data small, but causes alignment problems for machines that are not aligned on these boundaries. A large size such as eight means the data will be aligned on virtually every machine, but causes the encoded data to grow too large. Four was chosen as a compromise. Four is big enough to support most architectures efficiently.

This is not to say that the computers cannot utilize standard XDR, just that they do so at a greater overhead per data item than 4-byte (32-bit) architectures. Four is also small enough to keep the encoded data restricted to a reasonable size.

The same data should encode into an equivalent result on all machines, so that encoded data can be compared or checksummed. So, variable length data must be padded with trailing zeros.

XDR Data Type Declarations

Each of the sections that follow:

- Describe a data type defined in the XDR standard
- Show how that data type is declared in the language
- Include a graphic illustration of the encoding

For each data type in the language we show a general paradigm declaration. Note that angle brackets ($<$ and $>$) denote variable length sequences of data and square brackets ($[$ and $]$) denote fixed-length sequences of data. n , m and r denote integers.

For the full language specification, refer to “The XDR Language Specification” on page 275.

For some data types, specific examples are included. A more extensive example is given in the section, “XDR Data Description” on page 278.

Signed Integer

Description

An XDR signed integer is a 32-bit datum that encodes an integer in the range [-2147483648,2147483647]. The integer is represented in two’s complement notation; the most and least significant bytes are 0 and 3, respectively.

Declaration

Integers are declared:

```
int identifier;
```

Encoding

Integer

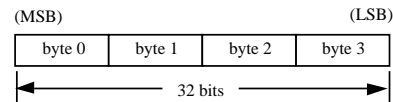

Unsigned Integer

Description

An XDR unsigned integer is a 32-bit datum that encodes a nonnegative integer in the range [0, 4294967295]. The integer is represented by an unsigned binary number whose most and least significant bytes are 0 and 3, respectively.

Declaration

An unsigned integer is declared as follows:

```
unsigned int identifier;
```

Encoding

Unsigned Integer

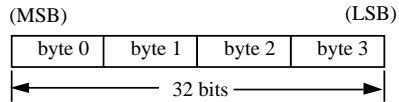

Enumerations

Description

Enumerations have the same representation as signed integers and are handy for describing subsets of the integers.

Declaration

Enumerated data is declared as follows:

```
enum {name-identifier = constant, ... } identifier;
```

For example, an enumerated type could represent the three colors red, yellow, and blue as follows:

```
enum {RED = 2, YELLOW = 3, BLUE = 5} colors;
```

It is an error to assign to an `enum` an integer that has not been assigned in the `enum` declaration.

Encoding

See “Signed Integer” on page 263.

Booleans

Description

Booleans are important enough and occur frequently enough to warrant their own explicit type in the standard. Booleans are integers of value 0 or 1.

Declaration

Booleans are declared as follows:

```
bool identifier;
```

This is equivalent to:

```
enum {FALSE = 0, TRUE = 1} identifier;
```

Encoding

See “Signed Integer” on page 263.

Hyper Integer and Unsigned Hyper Integer

Description

The standard defines 64-bit (8-byte) numbers called `hyper int` and `unsigned hyper int` whose representations are the obvious extensions of `integer` and `unsigned integer`, defined above. They are represented in two’s complement notation; the most and least significant bytes are 0 and 7, respectively.

Declaration

Hyper integers are declared as follows:

```
hyper int identifier;  
unsigned hyper int identifier;
```

Encoding

Hyper Integer

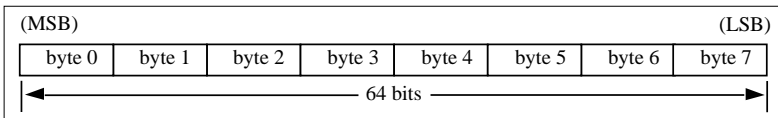

Floating Point

Description

The standard defines the floating-point data type `float` (32-bits or 4-bytes). The encoding used is the IEEE standard for normalized single-precision floating-point numbers [1]. The following three fields describe the single-precision floating-point number:

S: The sign of the number. Values 0 and 1 represent positive and negative, respectively. One bit.

E: The exponent of the number, base 2. There are eight bits in this field. The exponent is biased by 127.

F: The fractional part of the number's mantissa, base 2. There are 23 bits are in this field.

Therefore, the floating-point number is described by:

$$(-1)^{S} * 2^{(E-Bias)} * 1.F$$

Declaration

Single-precision floating-point data is declared as follows:

```
float identifier;
```

Double-precision floating-point data is declared as follows:

```
double identifier;
```

Encoding

Double-Precision Floating Point

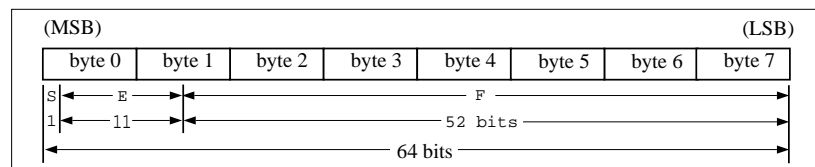

Just as the most and least significant bytes of an integer are 0 and 3, the most and least significant bits of a double-precision floating-point number are 0 and 63. The beginning bit (and most significant bit) offsets of S, E, and F are 0, 1, and 12, respectively.

These offsets refer to the logical positions of the bits, not to their physical locations (which vary from medium to medium).

The IEEE specifications should be consulted about the encoding for signed zero, signed infinity (overflow), and de-normalized numbers (underflow) [1]. According to

IEEE specifications, the NaN (not a number) is system dependent and should not be used externally.

Quadruple-Precision Floating Point

Description

The standard defines the encoding for the quadruple-precision floating-point data type `quadruple` (128 bits or 16 bytes). The encoding used is the IEEE standard for normalized quadruple-precision floating-point numbers [1]. The standard encodes the following three fields, which describe the quadruple-precision floating-point number:

S: The sign of the number. Values 0 and 1 represent positive and negative, respectively. One bit.

E: The exponent of the number, base 2. There are 15 bits in this field. The exponent is biased by 16383.

F: The fractional part of the number's mantissa, base 2. There are 111 bits in this field.

Therefore, the floating-point number is described by:

$$(-1)^{**S} * 2^{*(E-Bias)} * 1.F$$

Declaration

```
quadruple identifier;
```

Encoding

Quadruple-Precision Floating Point

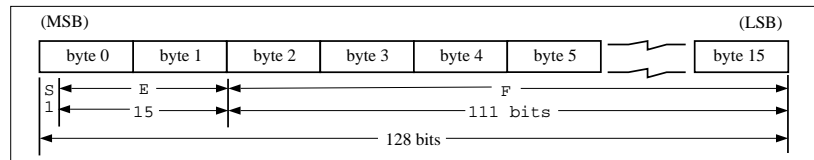

Just as the most and least significant bytes of an integer are 0 and 15, the most and least significant bits of a quadruple-precision floating-point number are 0 and 127. The beginning bit (and most significant bit) offsets of S, E, and F are 0, 1, and 16, respectively. These offsets refer to the logical positions of the bits, not to their physical locations (which vary from medium to medium).

The IEEE specifications should be consulted about the encoding for signed zero, signed infinity (overflow), and de-normalized numbers (underflow) [1]. According to IEEE specifications, the NaN (not a number) is system dependent and should not be used externally.

Fixed-Length Opaque Data

Description

At times, fixed-length uninterpreted data needs to be passed among machines. This data is called `opaque`.

Declaration

Opaque data is declared as follows:

```
opaque identifier[n];
```

where the constant n is the (static) number of bytes necessary to contain the opaque data. The n bytes are followed by enough (0 to 3) residual zero bytes, r , to make the total byte count of the opaque object a multiple of four.

Encoding

The n bytes are followed by enough (0 to 3) residual zero bytes, r , to make the total byte count of the opaque object a multiple of four.

Fixed-Length Opaque

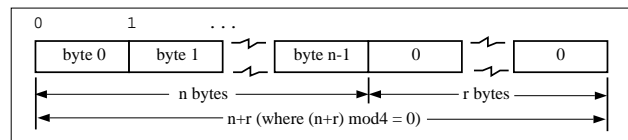

Variable-Length Opaque Data

Description

The standard also provides for variable-length (counted) opaque data, defined as a sequence of n (numbered 0 through $n-1$) arbitrary bytes to be the number n encoded as an unsigned integer (as described subsequently), and followed by the n bytes of the sequence.

Byte b of the sequence always precedes byte $b+1$ of the sequence, and byte 0 of the sequence always follows the sequence's length (count). The n bytes are followed by enough (0 to 3) residual zero bytes, r , to make the total byte count a multiple of four.

Declaration

Variable-length opaque data is declared in the following way:

```
opaque identifier<m>;
```

or

```
opaque identifier<>;
```

The constant m denotes an upper bound of the number of bytes that the sequence may contain. If m is not specified, as in the second declaration, it is assumed to be $(2^{32}) - 1$, the maximum length. For example, a filing protocol may state that the maximum data transfer size is 8192 bytes, as follows:

```
opaque filedata<8192>;
```

Encoding

Variable-Length Opaque

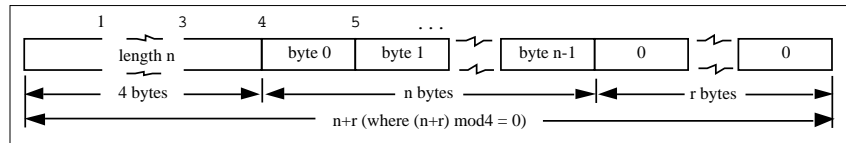

It is an error to encode a length greater than the maximum described in the specification.

Counted Byte Strings

Description

The standard defines a string of n (numbered 0 through $n-1$) ASCII bytes to be the number n encoded as an unsigned integer (as described previously), and followed by the n bytes of the string. Byte b of the string always precedes byte $b+1$ of the string, and byte 0 of the string always follows the string's length. The n bytes are followed by enough (0 to 3) residual zero bytes, r , to make the total byte count a multiple of four.

Declaration

Counted byte strings are declared as follows:

```
string object<m>;
```

or

```
string object<>;
```

The constant m denotes an upper bound of the number of bytes that a string may contain. If m is not specified, as in the second declaration, it is assumed to be $(2^{32}) - 1$, the maximum length. The constant m would normally be found in a protocol specification. For example, a filing protocol may state that a file name can be no longer than 255 bytes, as follows:

```
string filename<255>;
```

Encoding

String

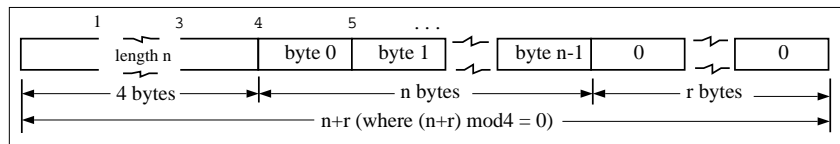

It is an error to encode a length greater than the maximum described in the specification.

Fixed-Length Array

Fixed-length arrays of elements numbered 0 through $n-1$ are encoded by individually encoding the elements of the array in their natural order, 0 through $n-1$. Each element's size is a multiple of four bytes. Though all elements are of the same type, the elements may have different sizes. For example, in a fixed-length array of strings, all elements are of type `string`, yet each element will vary in its length.

Declaration

Declarations for fixed-length arrays of homogenous elements are in the following form:

```
type-name identifier[n];
```

Encoding

Fixed-Length Array

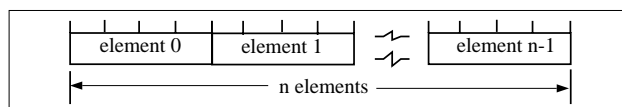

Variable-Length Array

Description

Counted arrays allow variable-length arrays to be encoded as homogeneous elements: the element count n (an unsigned integer) is followed by each array element, starting with element 0 and progressing through element $n-1$.

Declaration

The declaration for variable-length arrays follows this form:

```
type-name identifier<m>;
```

or

```
type-name identifier<>;
```

The constant m specifies the maximum acceptable element count of an array. If m is not specified, it is assumed to be $(2^{*}32) - 1$.

Encoding

Counted Array

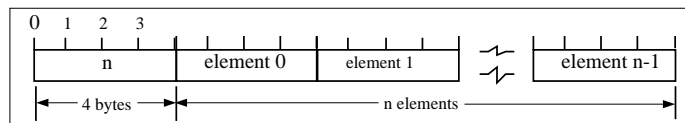

It is an error to encode a length greater than the maximum described in the specification.

Structure

Description

The components of the structure are encoded in the order of their declaration in the structure. Each component's size is a multiple of four bytes, though the components may be different sizes.

Declaration

Structures are declared as follows:

```
struct {
    component-declaration-A;
    component-declaration-B;
    ...
} identifier;
```

Encoding

Structure

component A	component B
-------------	-------------

Discriminated Union

Description

A discriminated union is a type composed of a discriminant followed by a type selected from a set of prearranged types according to the value of the discriminant. The type of discriminant is either `int`, `unsigned int`, or an enumerated type, such as `bool`. The component types are called arms of the union, and are preceded by the value of the discriminant that implies their encoding.

Declaration

Discriminated unions are declared as follows:

```
union switch (discriminant-declaration) {
    case discriminant-value-A:
        arm-declaration-A;
    case discriminant-value-B:
        arm-declaration-B;
    ...
    default:
        default-declaration;
} identifier;
```

Each `case` keyword is followed by a legal value of the discriminant. The default arm is optional. If it is not specified, then a valid encoding of the union cannot take on unspecified discriminant values. The size of the implied arm is always a multiple of four bytes.

The discriminated union is encoded as its discriminant followed by the encoding of the implied arm.

Encoding

Discriminated Union

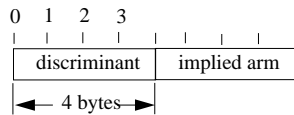

Void

Description

An XDR `void` is a 0-byte quantity. Voids are useful for describing operations that take no data as input or no data as output. They are also useful in unions, where some arms may contain data and others do not.

Declaration

The declaration is simply as follows:

```
void;
```

Constant

Description

`const` is used to define a symbolic name for a constant; it does not declare any data. The symbolic constant may be used anywhere a regular constant may be used.

The following example defines a symbolic constant `DOZEN`, equal to 12.

```
const DOZEN = 12;
```

Declaration

The declaration of a constant follows this form:

```
const name-identifier = n;
```

Typedef

`typedef` does not declare any data either, but serves to define new identifiers for declaring data. The syntax is:

```
typedef declaration;
```

The new type name is actually the variable name in the declaration part of the `typedef`. The following example defines a new type called `eggbox` using an existing type called `egg` and the symbolic constant `DOZEN`:

```
typedef egg eggbox[DOZEN];
```

Variables declared using the new type name have the same type as the new type name would have in the `typedef`, if it were considered a variable. For example, the following two declarations are equivalent in declaring the variable *fresheggs*:

```
eggbox fresheggs;
egg fresheggs[DOZEN];
```

When a `typedef` involves a `struct`, `enum`, or `union` definition, there is another (preferred) syntax that may be used to define the same type. In general, a `typedef` of the following form:

```
typedef <<struct, union, or enum definition>> identifier;
```

may be converted to the alternative form by removing the `typedef` part and placing the identifier after the `struct`, `enum`, or `union` keyword, instead of at the end. For example, here are the two ways to define the type `bool`:

```
typedef enum { /* using typedef */
    FALSE = 0,
    TRUE = 1
} bool;
enum bool { /* preferred alternative */
    FALSE = 0,
    TRUE = 1
};
```

This syntax is preferred because one does not have to go to the end of a declaration to learn the name of the new type.

Optional-Data

Optional-data is one kind of union that occurs so frequently that it is given a special syntax of its own for declaring it. It is declared as follows:

```
type-name *identifier;
```

This is equivalent to the following union:

```
union switch (bool opted) {
    case TRUE:
        type-name element;
    case FALSE:
        void;
} identifier;
```

It is also equivalent to the following variable-length array declaration, since the Boolean `opted` can be interpreted as the length of the array:

```
type-name identifier<1>;
```

Optional-data is useful for describing recursive data-structures, such as linked lists and trees.

The XDR Language Specification

Notational Conventions

This specification uses a modified Backus-Naur Form notation for describing the XDR language. Here is a brief description of the notation:

1. The characters `|`, `(`, `)`, `[`, `]`, and `*` are special.
2. Terminal symbols are strings of any characters embedded in quotes (`"`).
3. Nonterminal symbols are strings of nonspecial italic characters.
4. Alternative items are separated by a vertical bar (`|`).
5. Optional items are enclosed in brackets.
6. Items are grouped together by enclosing them in parentheses.
7. A `*` following an item means 0 or more occurrences of the item.

For example, consider the following pattern:

```
"a " "very" (" " " " very")* [" cold " "and"] " rainy "  
  ("day" | "night")
```

An infinite number of strings match this pattern. A few of them are:

```
a very rainy day  
a very, very rainy day  
a very cold and rainy day  
a very, very, very cold and rainy night
```

Lexical Notes

1. Comments begin with `/*` and end with `*/`.
2. White space serves to separate items and is otherwise ignored.
3. An identifier is a letter followed by an optional sequence of letters, digits, or underbars (`_`). The case of identifiers is not ignored.
4. A constant is a sequence of one or more decimal digits, optionally preceded by a minus-sign (`-`).

CODE EXAMPLE C-1 XDR Specification

```
Syntax Information
declaration:
  type-specifier identifier
  | type-specifier identifier "[" value "]"
  | type-specifier identifier "<" [ value ] ">"
  | "opaque" identifier "[" value "]"
  | "opaque" identifier "<" [ value ] ">"
  | "string" identifier "<" [ value ] ">"
  | type-specifier "*" identifier
  | "void"

value:
  constant
  | identifier

type-specifier:
  [ "unsigned" ] "int"
  | [ "unsigned" ] "hyper"
  | "float"
  | "double"
  | "quadruple"
  | "bool"
  | enum-type-spec
  | struct-type-spec
  | union-type-spec
  | identifier

enum-type-spec:
  "enum" enum-body

enum-body:
  "{"
  ( identifier "=" value )
  ( "," identifier "=" value ) *
  "}"

struct-type-spec:
  "struct" struct-body

struct-body:
  "{"
  ( declaration ";" )
  ( declaration ";" ) *
  "}"

union-type-spec:
  "union" union-body

union-body:
  "switch" "(" declaration ")" "{"
  ( "case" value ":" declaration ";" )
  ( "case" value ":" declaration ";" ) *
  [ "default" ":" declaration ";" ]
  "}"
```

(continued)

(Continuation)

```
constant-def:
  "const" identifier "=" constant ";"

type-def:
  "typedef" declaration ";"
  | "enum" identifier enum-body ";"
  | "struct" identifier struct-body ";"
  | "union" identifier union-body ";"

definition:
  type-def
  | constant-def

specification:
  definition *
```

Syntax Notes

The following are keywords and cannot be used as identifiers:

TABLE C-1 XDR Keywords

bool	const	enum	int	string	typedef	void
cas	default	float	opaque	struct	union	
cha	double	hyper	quadruple	switch	unsigned	

1. Only unsigned constants may be used as size specifications for arrays. If an identifier is used, it must have been declared previously as an unsigned constant in a `const` definition.
2. Constant and type identifiers within the scope of a specification are in the same name space and must be declared uniquely within this scope.
3. Similarly, variable names must be unique within the scope of `struct` and `union` declarations. Nested `struct` and `union` declarations create new scopes.
4. The discriminant of a union must be of a type that evaluates to an integer. That is, `int`, `unsigned int`, `bool`, an `enum` type, or any `typedef` that evaluates to one of these. Also, the case values must be legal discriminant values. Finally, a case value may not be specified more than once within the scope of a union declaration.

XDR Data Description

Here is a short XDR data description of a file data structure, which might be used to transfer files from one machine to another.

CODE EXAMPLE C-2 XDR File Data Structur

```
const MAXUSERNAME = 32; /* max length of a user name */
const MAXFILELEN = 65535; /* max length of a file */
const MAXNAMELEN = 255; /* max length of a file name */

/* Types of files: */
enum filekind {
    TEXT = 0, /* ascii data */
    DATA = 1, /* raw data */
    EXEC = 2 /* executable */
};

/* File information, per kind of file: */
union filetype switch (filekind kind) {
    case TEXT:
        void; /* no extra information */
    case DATA:
        string creator<MAXNAMELEN>; /* data creator */
    case EXEC:
        string interpreter<MAXNAMELEN>; /*proginterp*/
};

/* A complete file: */
struct file {
    string filename<MAXNAMELEN>; /* name of file */
    filetype type; /* info about file */
    string owner<MAXUSERNAME>; /* owner of file */
    opaque data<MAXFILELEN>; /* file data */
};
```

Suppose now that there is a user named john who wants to store his LISP program sillyprog that contains just the data quit. His file would be encoded as follows:

TABLE C-2 XDR Data Description Example

Offset	Hex Bytes	ASCII	Description
0	00 00 00 09	Length of filename = 9
4	73 69 6c 6c	sill	Filename characters
8	79 70 72 6f	ypro	... and more characters ...

TABLE C-2 XDR Data Description Example (continued)

Offset	Hex Bytes	ASCII	Description
12	67 00 00 00	g...	.. and 3 zero-bytes of fill
16	00 00 00 02	Filekind is EXEC = 2
20	00 00 00 04	Length of interpreter = 4
24	6c 69 73 70	lisp	Interpreter characters
28	00 00 00 04	Length of owner = 4
32	6a 6f 68 6e	john	Owner characters
36	00 00 00 06	Length of file data = 6
40	28 71 75 69	(qu	File data bytes ...
44	74 29 00 00	t)..	... and 2 zero-bytes of fill

RPC Language Reference

The RPC language is an extension of the XDR language. The sole extension is the addition of the program and version types.

For a description of the RPC extensions to the XDR language, see Appendix B.

The RPC language is similar to C. This section describes the syntax of the RPC language, showing a few examples along the way. It also shows how RPC and XDR type definitions get compiled into C type definitions in the output header file.

An RPC language file consists of a series of definitions.

```
definition-list:
    definition;
definition; definition-list
```

It recognizes six types of definitions.

```
definition:
    enum-definition
    const-definition
    typedef-definition
    struct-definition
    union-definition
```

```
program-definition
```

Definitions are not the same as declarations. No space is allocated by a definition – only the type definition of a single or series of data elements. This means that variables still must be declared.

Enumerations

RPC/XDR enumerations have similar syntax as C enumerations.

```
enum-definition:
    "enum" enum-ident "{"
    enum-value-list
    "}"
```

```
enum-value-list:
    enum-value
    enum-value "," enum-value-list
```

```
enum-value:
    enum-value-ident
    enum-value-ident "=" value
```

Here is an example of an XDR enum and the C enum to which it gets compiled.

```
enum colortype {
    RED = 0,
    GREEN = 1,
    BLUE = 2
};

enum colortype {
    RED = 0,
    GREEN = 1,
    BLUE = 2,
};
typedef enum colortype colortype;
```

Constants

XDR symbolic constants may be used wherever an integer constant is used. For example, in array size specifications:

```
const-definition:
    const const-ident = integer
```

The following example defines a constant, DOZEN as equal to 12:

```
const DOZEN = 12; --> #define DOZEN 12
```

Type Definitions

XDR typedefs have the same syntax as C typedefs.

```
typedef-definition:
    typedef declaration
```

This example defines an `fname_type` used for declaring file name strings that have a maximum length of 255 characters.

```
typedef string fname_type<255>; --> typedef char *fname_type;
```

Declarations

In XDR, there are four kinds of declarations. These declarations must be a part of a struct or a typedef; they cannot stand alone:

```
declaration:
  simple-declaration
  fixed-array-declaration
  variable-array-declaration
  pointer-declaration
```

Simple Declarations

Simple declarations are just like simple C declarations:

```
simple-declaration:
  type-ident variable-ident
```

Example:

```
colortype color; --> colortype color;
```

Fixed-Length Array Declarations

Fixed-length array declarations are just like C array declarations:

```
fixed-array-declaration:
  type-ident variable-ident [value]
```

Example:

```
colortype palette[8]; --> colortype palette[8];
```

Many programmers confuse variable declarations with type declarations. It is important to note that `rpcgen` does not support variable declarations. This example is a program that will not compile:

```
int data[10];
program P {
  version V {
    int PROC(data) = 1;
  } = 1;
} = 0x200000;
```

The example above will not compile because of the variable declaration:

```
int data[10]
```

Instead, use:

```
typedef int data[10];
```

or

```
struct data {int dummy [10]};
```

Variable-Length Array Declarations

Variable-length array declarations have no explicit syntax in C. The XDR language does have a syntax, using angle brackets:

```
variable-array-declaration:
    type-ident variable-ident <value>
    type-ident variable-ident < >
```

The maximum size is specified between the angle brackets. The size may be omitted, indicating that the array may be of any size:

```
int heights<12>; /* at most 12 items */
int widths<>; /* any number of items */
```

Because variable-length arrays have no explicit syntax in C, these declarations are compiled into `struct` declarations. For example, the `heights` declaration compiled into the following `struct`:

```
struct {
    u_int heights_len; /* # of items in array */
    int *heights_val; /* pointer to array */
} heights;
```

The number of items in the array is stored in the `_len` component and the pointer to the array is stored in the `_val` component. The first part of each component name is the same as the name of the declared XDR variable (`heights`).

Pointer Declarations

Pointer declarations are made in XDR exactly as they are in C. Address pointers are not really sent over the network; instead, XDR pointers are useful for sending recursive data types such as lists and trees. The type is called “optional-data,” not “pointer,” in XDR language:

```
pointer-declaration:
    type-ident *variable-ident
```

Example:

```
listitem *next; --> listitem *next;
```

Structures

An RPC/XDR `struct` is declared almost exactly like its C counterpart. It looks like the following:

```
struct-definition:
    struct struct-ident "{"
        declaration-list
    "}"
```

```

declaration-list:
    declaration ";"
    declaration ";" declaration-list

```

The following XDR structure is an example of a two-dimensional coordinate and the C structure that it compiles into:

```

struct coord {
    int x;
    int y;
};
-->
struct coord {
    int x;
    int y;
};
typedef struct coord coord;

```

The output is identical to the input, except for the added `typedef` at the end of the output. This enables one to use `coord` instead of `struct coord` when declaring items.

Unions

XDR unions are discriminated unions, and do not look like C unions – they are more similar to Pascal variant records:

```

union-definition:
    "union" union-ident "switch" "("("simple declaration")" "{"
        case-list
    "}"
case-list:
    "case" value ":" declaration ";"
    "case" value ":" declaration ";" case-list
    "default" ":" declaration ";"

```

The following is an example of a type returned as the result of a “read data” operation: If there is no error, return a block of data; otherwise, don’t return anything.

```

union read_result switch (int errno) {
    case 0:
        opaque data[1024];
    default:
        void;
};

```

It compiles into the following:

```

struct read_result {
    int errno;
    union {
        char data[1024];
    } read_result_u;
};
typedef struct read_result read_result;

```

Notice that the union component of the output struct has the same name as the type name, except for the trailing `_u`.

Programs

RPC programs are declared using the following syntax:

```
program-definition:
    "program" program-ident "{"
        version-list
    "}" "=" value;
version-list:
    version ";"
    version ";" version-list
version:
    "version" version-ident "{"
        procedure-list
    "}" "=" value;
procedure-list:
    procedure ";"
    procedure ";" procedure-list
procedure:
    type-ident procedure-ident "(" type-ident ")" "=" value;
```

When the `-N` option is specified, `rpcgen` also recognizes the following syntax:

```
procedure:
    type-ident procedure-ident "(" type-ident-list ")" "=" value;
type-ident-list:
    type-ident
    type-ident "," type-ident-list
```

For example:

```
/*
 * time.x: Get or set the time. Time is represented as seconds
 * since 0:00, January 1, 1970.
 */
program TIMEPROG {
    version TIMEEVERS {
        unsigned int TIMEGET(void) = 1;
        void TIMESET(unsigned) = 2;
    } = 1;
} = 0x20000044;
```

Note that the `void` argument type means that no argument is passed.

This file compiles into these `#define` statements in the output header file:

```
#define TIMEPROG 0x20000044
#define TIMEEVERS 1
#define TIMEGET 1
#define TIMESET 2
```

Special Cases

There are several exceptions to the RPC language rules.

C-style Mode

In the new features section we talked about the features of the C-style mode of `rpcgen`. These features have implications with regard to the passing of `void` arguments. No arguments need be passed if their value is `void`.

Booleans

C has no built-in `boolean` type. However, the RPC library uses a `boolean` type called `bool_t` that is either `TRUE` or `FALSE`. Parameters declared as type `bool` in XDR language are compiled into `bool_t` in the output header file.

Example:

```
bool married; --> bool_t married;
```

Strings

The C language has no built-in `string` type, but instead uses the null-terminated `char *` convention. In C, strings are usually treated as null-terminated single-dimensional arrays.

In XDR language, strings are declared using the `string` keyword, and compiled into type `char *` in the output header file. The maximum size contained in the angle brackets specifies the maximum number of characters allowed in the strings (not counting the `NULL` character). The maximum size may be omitted, indicating a string of arbitrary length.

Examples:

```
string name<32>; --> char *name;
string longname<>; --> char *longname;
```

Note - `NULL` strings cannot be passed; however, a zero-length string (that is, just the terminator or `NULL` byte) can be passed.

Opaque Data

Opaque data is used in XDR to describe untyped data, that is, sequences of arbitrary bytes. It may be declared either as a fixed length or variable length array. Examples:

```
opaque diskblock[512]; --> char diskblock[512];
opaque filedata<1024>; --> struct {
```

```
    u_int filedata_len;  
    char *filedata_val;  
} filedata;
```

Voids

In a `void` declaration, the variable is not named. The declaration is just `void` and nothing else. Void declarations can only occur in two places: union definitions and program definitions (as the argument or result of a remote procedure, for example no arguments are passed.)

Live RPC Code Examples

This appendix contains copies of the complete live code modules used in the `rpcgen` and RPC chapters of this book. They are compilable as they are written and will run (unless otherwise noted to be pseudo-code or the like). They are provided for informational purposes only. Sun Microsystems assumes no liability from their use.

Directory Listing Program and Support Routines (`rpcgen`)

CODE EXAMPLE D-1 `rpcgen` Program: `dir.x`

```
/*
 * dir.x: Remote directory listing
 * protocol
 *
 * This source module is a rpcgen source module
 * used to demonstrate the functions of the rpcgen
 * tool.
 *
 * It is compiled with the rpcgen -h -T switches to
 * generate both the header (.h) file and the
 * accompanying data structures.
 */
const MAXNAMELEN = 255; /*maxlengthofadirectoryentry*/

typedef string nametype<MAXNAMELEN>; /* directory entry */
typedef struct namenode *namelist; /*linkinthelisting*/
/*
```

(continued)

(Continuation)

```
* A node in the directory listing
*/
struct namenode {
    nametype name;          /* name of directory entry */
    namelist next;         /* next entry */
};

/*
 * The result of a READDIR operation:
 * a truly portable application would use an agreed upon list of
 * error codes rather than, as this sample program does, rely
upon
 * passing UNIX errno's back. In this example the union is used
to
 * discriminate between successful and unsuccessful remote
calls.
*/
union readdir_res switch (int errno) {
    case 0:
        namelist list; /*no error: return directory listing*/
    default:
        void;          /*error occurred: nothing else to return*/
};

/*
 * The directory program definition
 */
program DIRPROG {
    version DIRVERS {
        readdir_res
        READDIR(nametype) = 1;
    } = 1;
} = 0x20000076;
```

CODE EXAMPLE D-2 Remote dir_proc.c

```
/*
 * dir_proc.c: remote readdir implementation
 */
#include <rpc/rpc.h>          /* Always needed */
#include <dirent.h>
#include "dir.h"             /* Created by rpcgen */

extern int errno;
extern char *malloc();
extern char *strdup();
```

(continued)

(Continuation)

```
/* ARGUSED1*/
readdir_res *
readdir_1(dirname, req)
    nametype *dirname;
    struct svc_req *req;
{
    DIR *dirp;
    struct dirent *d;
    namelist nl;
    namelist *nlp;
    static readdir_res res; /* must be static! */

    /*
     * Open directory
     */
    dirp = opendir(*dirname);
    if (dirp == (DIR *)NULL) {
        res.errno = errno;
        return (&res);
    }
    /*
     * Free previous result
     */
    xdr_free(xdr_readdir_res, &res);
    /*
     * Collect directory entries. Memory allocated here is freed
     by
     * xdr_free the next time readdir_1 is called.
     */

    nlp = &res.readdir_res_u.list;
    while (d = readdir(dirp)) {
        nl = *nlp = (namenode *) malloc(sizeof(namenode));
        if (nl == (namenode *) NULL) {
            res.errno = EAGAIN;
            closedir(dirp);
            return(&res);
        }
        nl->name = strdup(d->d_name);
        nlp = &nl->next;
    }
    *nlp = (namelist)NULL;
    /* Return the result */
    res.errno = 0;
    closedir(dirp);
    return (&res);
}
```

CODE EXAMPLE D-3 rls.c Client

```
/*
 * rls.c: Remote directory listing client
 */

#include <stdio.h>
#include <rpc/rpc.h> /* always need this */
#include "dir.h" /* generated by rpcgen */

extern int errno;

main(argc, argv)
    int argc;
    char *argv[];
{
    CLIENT *cl;
    char *server;
    char *dir;
    readdir_res *result;
    namelist nl;

    if (argc != 3) {
        fprintf(stderr, "usage: %s host directory\n",
            argv[0]);
        exit(1);
    }
    server = argv[1];
    dir = argv[2];
    /*
     * Create client "handle" used for calling MESSAGEPROG on the
     server
     * designated on the command line.
     */
    cl = clnt_create(server, DIRPROG, DIRVERS, "visible");
    if (cl == (CLIENT *)NULL) {
        clnt_pcreateerror(server);
        exit(1);
    }

    result = readdir_1(&dir, cl);
    if (result == (readdir_res *)NULL) {
        clnt_perror(cl, server);
        exit(1);
    }

    /* Okay, we successfully called the remote procedure. */

    if (result->errno != 0) {
        /*
         * A remote system error occurred. Print error message and
         die.
         */
    }
    if (result->errno < sys_nerr)
        fprintf(stderr, "%s : %s\n", dir,
            sys_enlist[result->errno]);
}
```

(continued)

(Continuation)

```
        errno = result->errno;
        perror(dir);
        exit(1);
    }

    /* Successfully got a directory listing. Print it out. */
    for(nl = result->readdir_res_u.list; nl != NULL; nl = nl-
>next) {
        printf("%s\n", nl->name);
    }
    exit(0);
```

Time Server Program (rpcgen)

CODE EXAMPLE D-4 rpcgen Program: time.x

```
/*
 * time.x: Remote time protocol
 */
program TIMEPROG {
    version TIMEVERS {
        unsigned int TIMEGET(void) = 1;
    } = 1;
} = 0x20000044;

#ifdef RPC_SVC
%int *
%timeget_1()
%{
% static int thetime;
%
% thetime = time(0);
% return (&thetime);
%}
#endif
```

Add Two Numbers Program (rpcgen)

CODE EXAMPLE D-5 rpcgen program: Add Two Numbers

```
/* This program contains a procedure to add 2 numbers to
demonstrate
 * some of the features of the new rpcgen. Note that add() takes 2
 * arguments in this case.
 */
program ADDPROG { /* program number */
  version ADDVER { /* version number */
    int add ( int, int ) /* procedure */
      = 1;
  } = 1;
} = 199;
```

Spray Packets Program (rpcgen)

Refer to the notes section on the `spray(1M)` man page for information about using this tool.

CODE EXAMPLE D-6 rpcgen program: spray.x

```
/*
 * Copyright (c) 1987, 1991 by Sun Microsystems, Inc.
 */

/* from spray.x */

#ifdef RPC_HDR
#pragma ident "@(#)spray.h 1.2 91/09/17 SMI"
#endif

/*
 * Spray a server with packets
 * Useful for testing flakiness of network interfaces
 */

const SPRAYMAX = 8845; /* max amount can spray */
```

(continued)

(Continuation)

```
/*
 * GMT since 0:00, 1 January 1970
 */
struct spraytimeval {
    unsigned int sec;
    unsigned int usec;
};

/*
 * spray statistics
 */
struct spraycumul {
    unsigned int counter;
    spraytimeval clock;
};

/*
 * spray data
 */
typedef opaque sprayarr<SPRAYMAX>;

program SPRAYPROC {
    version SPRAYVERS {
        /*
         * Just throw away the data and increment the counter. This
         * call never returns, so the client should always time it
         out.
         */
        void
        SPRAYPROC_SPRAY(sprayarr) = 1;

        /*
         * Get the value of the counter and elapsed time since last
         * CLEAR.
         */
        spraycumul
        SPRAYPROC_GET(void) = 2;

        /*
         * Clear the counter and reset the elapsed time
         */
        void
        SPRAYPROC_CLEAR(void) = 3;
    } = 1;
} = 100012;
```

Print Message Program With Remote Version

CODE EXAMPLE D-7 printmesg.c

```
/* printmesg.c: print a message on the console */
#include <stdio.h>

main(argc, argv)
    int argc;
    char *argv[];
{
    char *message;

    if (argc != 2) {
        fprintf(stderr, "usage: %s <message>\n", argv[0]);
        exit(1);
    }
    message = argv[1];
    if( !printmessage(message) ) {
        fprintf(stderr, "%s: couldn't print your message\n",
            argv[0]);
        exit(1);
    }
    printf("Message Delivered!\n");
    exit(0);
}

/* Print a message to the console. */

/*
 * Return a boolean indicating whether the message was actually
 * printed.
 */
printmessage(msg)
    char *msg;
{
    FILE *f;

    if = fopen("/dev/console", "w");
    if (f == (FILE *)NULL)
        return (0);
    fprintf(f, "%sen'", msg);
    fclose(f);
    return (1);
}
```

CODE EXAMPLE D-8 Remote Version of printmsg.c

```
/* * rprintmsg.c: remote version of "printmsg.c" */
#include <stdio.h>
#include <rpc/rpc.h> /* always needed */
#include "msg.h" /* msg.h generated by rpcgen */

main(argc, argv)
int argc;
char *argv[];
{
    CLIENT *cl;
    int *result;
    char *server;
    char *message;
    extern int sys_nerr;
    extern char *sys_errlist[];

    if (argc != 3) {
        fprintf(stderr, "usage: %s host message", argv[0]);
        exit(1);
    }
    /*
     * Save values of command line arguments
     */
    server = argv[1];
    message = argv[2];
    /*
     * Create client "handle" used for calling
     * MESSAGEPROG on the server
     * designated on the command line.
     */
    cl = clnt_create(server, MESSAGEPROG, PRINTMESSAGEVERS,
                    "visible");
    if (cl == (CLIENT *)NULL) {
        /*
         * Couldn't establish connection with server.
         * Print error message and die.
         */
        clnt_pcreateerror(server);
        exit(1);
    }
    /* Call the remote procedure "printmessage" on the server */
    result = printmessage_1(&message, cl);
    if (result == (int *)NULL) {
        /*
         * An error occurred while calling the server.
         * Print error message and die.
         */
        clnt_perror(cl, server);
        exit(1);
    }
    /* Okay, we successfully called the remote procedure. */
    if (*result == 0) {
        /*
         * Server was unable to print our message.
         * Print error message and die.
         */
    }
}
```

(continued)

(Continuation)

```
    */
    fprintf(stderr, "%s"
}
/* The message got printed on the server's console */
printf("Message delivered to %s!\n", server);
exit(0);
}
```

CODE EXAMPLE D-9 rpcgen Program: msg.x

```
/* msg.x: Remote message printing protocol */
program MESSAGEPROG {
    version MESSAGEEVERS {
        int PRINTMESSAGE(string) = 1;
    } = 1;
} = 0x20000001;
```

CODE EXAMPLE D-10 mesg_proc.c

```
/*
 * msg_proc.c: implementation of the remote
 * procedure "printmessage"
 */

#include <stdio.h>
#include <rpc/rpc.h> /* always needed */
#include "msg.h" /* msg.h generated by rpcgen */

/*
 * Remote version of "printmessage"
 */
/*ARGSUSED1*/
int printmessage_1(msg, req)
char **msg;
struct svc_req *req;
{
    static int result; /* must be static! */
    FILE *f;

    f = fopen("/dev/console", "w");
    if (f == (FILE *)NULL) {
```

(continued)

(Continuation)

```
    result = 0;
    return (&result);
}
fprintf(f, "%sen", *msg);
fclose(f);
result = 1;
return (&result);
}
```

Batched Code Example

CODE EXAMPLE D-11 Batched Client Program

```
#include <stdio.h>
#include <rpc/rpc.h>
#include "windows.h"

main(argc, argv)
    int      argc;
    char     **argv;
{
    struct timeval  total_timeout;
    register CLIENT *client;
    enum clnt_stat  clnt_stat;
    char           buf[1000], *s = buf;

    if ((client = clnt_create(argv[1], WINDOWPROG, WINDOWVERS,
                             "CIRCUIT_V")) == (CLIENT *) NULL) {
        clnt_pcreateerror("clnt_create");
        exit(1);
    }

    timerclear(&total_timeout);
    while (scanf("%s", s) != EOF) {
        clnt_call(client, RENDERSTRING_BATCHED, xdr_wrapstring,
                 &s, xdr_void, (caddr_t) NULL, total_timeout);
    }

    /* Now flush the pipeline */
    total_timeout.tv_sec = 20;
    clnt_stat = clnt_call(client, NULLPROC, xdr_void,
```

(continued)

(Continuation)

```
        (caddr_t) NULL, xdr_void, (caddr_t) NULL,
total_timeout);
    if (clnt_stat != RPC_SUCCESS) {
        clnt_perror(client, "rpc");
        exit(1);
    }
    clnt_destroy(client);
    exit(0);
}
```

CODE EXAMPLE D-12 Batched Server Program

```
#include <stdio.h>
#include <rpc/rpc.h>
#include "windows.h"

void        windowdispatch();
main()
{
    int num;

    num = svc_create(windowdispatch, WINDOWPROG, WINDOWVERS,
        "CIRCUIT_V");
    if (num == 0) {
        fprintf(stderr, "can't create an RPC server\n");
        exit(1);
    }
    svc_run();                /* Never returns */
    fprintf(stderr, "should never reach this point\n");
}

void
windowdispatch(rqstp, transp)
    struct svc_req *rqstp;
    SVCXPRT      *transp;
{
    char          *s = NULL;

    switch (rqstp->rq_proc) {
    case NULLPROC:
        if (!svc_sendreply(transp, xdr_void, 0))
            fprintf(stderr, "can't reply to RPC call\n");
        return;
    case RENDERSTRING:
        if (!svc_getargs(transp, xdr_wrapstring, &s)) {
            fprintf(stderr, "can't decode arguments\n");
            /* Tell caller an error occurred */
        }
    }
}
```

(continued)

(Continuation)

```
        svcerr_decode(transp);
        break;
    }
    /* Code here to render the string s */
    if (!svc_sendreply(transp, xdr_void, (caddr_t) NULL))
        fprintf(stderr, "can't reply to RPC call\n");
    break;
case RENDERSTRING_BATCHED:
    if (!svc_getargs(transp, xdr_wrapstring, &s)) {
        fprintf(stderr, "can't decode arguments\n");
        /* Be silent in the face of protocol errors */
        break;
    }
    /* Code here to render string s, but send no reply! */
    break;
default:
    svcerr_noproc(transp);
    return;
}
/* Now free string allocated while decoding arguments */
svc_freeargs(transp, xdr_wrapstring, &s);
}
```

Non-Batched Example

This example is included for reference only. It is a version of the batched client string rendering service, written in as a non-batched program.

CODE EXAMPLE D-13 Unbatched Version of Batched Client

```
#include <stdio.h>
#include <rpc/rpc.h>
#include "windows.h"

main(argc, argv)
    int     argc;
    char    **argv;
{
    struct timeval total_timeout;
    register CLIENT *client;
    enum clnt_stat clnt_stat;
```

(continued)

(Continuation)

```
char          buf[1000], *s = buf;

if ((client = clnt_create(argv[1], WINDOWPROG, WINDOWVERS,
                        "CIRCUIT_V")) == (CLIENT *) NULL) {
    clnt_pcreateerror("clnt_create");
    exit(1);
}
total_timeout.tv_sec = 20;
total_timeout.tv_usec = 0;
while (scanf("%s", s) != EOF) {
    if(clnt_call(client, RENDERSTRING, xdr_wrapstring, &s,
                xdr_void, (caddr_t) NULL, total_timeout) != RPC_SUCCESS) {
        clnt_perror(client, "rpc");
        exit(1);
    }
}
clnt_destroy(client);
exit(0);
}
```

The portmap Utility

The `rpcbind` utility replaces the `portmap` utility available in previous releases of the Solaris environment. This appendix is included to help you understand the history of port and network address resolution using the `portmap` utility.

Solaris RPC-based services use `portmap` as a system registration service. It manages a table of correspondences between ports (logical communications channels) and the services registered at them. It provides a standard way for a client to look up the TCP/IP or UDP/IP port number of an RPC program supported by the server.

System Registration Overview

For client programs to find distributed services on a network, they need a way to look up the network addresses of server programs. Network transport (protocol) services do not provide this function. Their task is to provide process-to-process message transfer across a network (that is, a message is sent to a transport-specific network address). A network address is a logical communications channel—by listening on a specific network address, a process receives messages from the network.

The way a process waits on a network address varies from one operating system to the next, but all provide mechanisms by which a process can synchronize its activity with arriving messages. Messages are not sent across networks to receiving processes, but rather to the network address at which receiving processes pick them up. Network addresses are valuable because they allow message receivers to be specified in a way that is independent of the conventions of the receiving operating system. `TI-RPC`, being transport independent, makes no assumptions about the structure of a network address. It uses a universal addresses. This universal address is specified as a null-terminated string of characters. Such universal addresses are translated into local transport addresses by routines specific to each transport provider.

The `rpcbind` protocol defines a network service that provides a standard way for clients to look up the network address of any remote program supported by a server. Because it can be implemented on any transport, it provides a single solution to a general problem that works for all clients, all servers, and all networks.

portmap Protocol

The `portmap` program maps RPC program and version numbers to transport-specific port numbers. This program makes dynamic binding of remote programs possible.

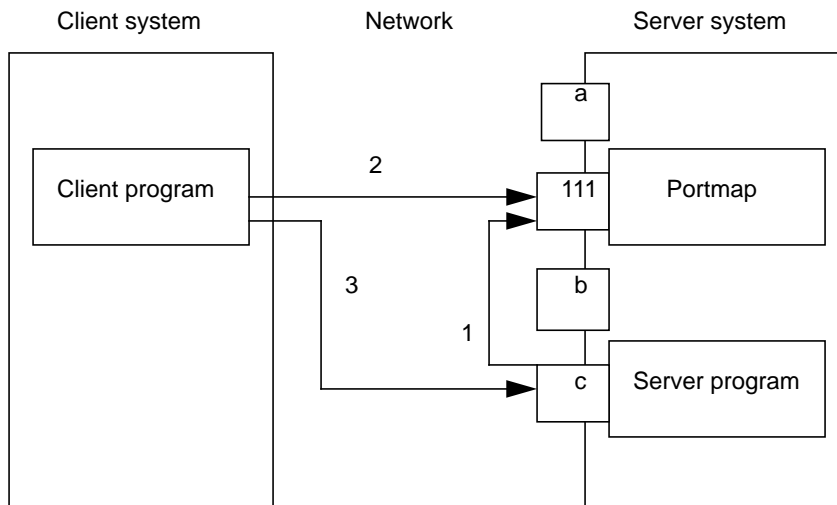

Figure E-1 Typical Portmap Sequence (For TCP/IP Only)

Figure E-1 shows the process:

1. The server registers with `portmap`
2. The client gets the server's port from `portmap`
3. The client calls the server.

The range of reserved port numbers is small and the number of potential remote programs is very large. By running only the port mapper on a well known port, the port numbers of other remote programs can be ascertained by querying the port mapper. In Figure E-1, `a`, `111`, `b`, and `c` represent port numbers, where `111` is the assigned portmapper port number.

The port mapper also aids in broadcast RPC. A given RPC program usually has different port number bindings on different machines, so there is no way to directly broadcast to all of these programs. The port mapper, however, does have a fixed port number. So, to broadcast to a given program, the client actually sends its message to

the port mapper located at the broadcast address. Each port mapper that receives the broadcast then calls the local service specified by the client. When portmap gets the reply from the local service, it returns the reply to the client. The portmap protocol specification is shown in Code Example E-1.

CODE EXAMPLE E-1 portmap Protocol Specification (in RPC Language)

```
const PMAP_PORT = 111;          /* portmapper port number */
/*
 * A mapping of (program, version, protocol) to port number
 */
struct pmap {
    rpcprog_t prog;
    rpcvers_t vers;
    rpcprot_t prot;
    rpcport_t port;
};
/*
 * Supported values for the "prot" field
 */
const IPPROTO_TCP = 6; /* protocol number for TCP/IP */
const IPPROTO_UDP = 17; /* protocol number for UDP/IP */
/*
 * A list of mappings
 */
struct pmaplist {
    pmap map;
    pmaplist *next;
};
/*
 * Arguments to callit
 */
struct call_args {
    rpcprog_t prog;
    rpcvers_t vers;
    rpcproc_t proc;
    opaque args<>;
};
/*
 * Results of callit
 */
struct call_result {
    rpcport_t port;
    opaque res<>;
};
/*
 * Port mapper procedures
 */
program PMAP_PROG {
    version PMAP_VERS {
        void
        PMAPPROC_NULL(void) = 0;
        bool
        PMAPPROC_SET(pmap) = 1;
        bool
```

(continued)

(Continuation)

```
PMAPPROC_UNSET(pmap) = 2;
unsigned int
PMAPPROC_GETPORT(pmap) = 3;
pmaplist
PMAPPROC_DUMP(void) = 4;
call_result
PMAPPROC_CALLIT(call_args) = 5;
} = 2;
} = 100000;
```

portmap Operation

portmap currently supports two protocols (UDP/IP and TCP/IP). portmap is contacted by talking to it on assigned port number 111 (SUNRPC (5)) on either of these protocols. The following is a description of each of the portmapper procedures.

PMAPPROC_NULL

This procedure does no work. By convention, procedure zero of any protocol takes no parameters and returns no results.

PMAPPROC_SET

When a program first becomes available on a machine, it registers itself with the local port map program. The program passes its program number *prog*, version number *vers*, transport protocol number *prot*, and the port *port* on which it receives service requests. The procedure refuses to establish a mapping if one already exists for the specified *port* and it is bound. If the mapping exists and the *port* is not bound, portmap unregisters the *port* and performs the requested mapping. The procedure returns TRUE if the procedure successfully established the mapping and FALSE otherwise. See also the `pmap_set()` function in the `rpc_soc(3NSL)` man page.

PMAPPROC_UNSET

When a program becomes unavailable, it should unregister itself with the port mapper program on the same machine. The parameters and results have meanings identical to those of `PMAPPROC_SET`. The *protocol* and *port number* fields of the argument are ignored. See also the `pmap_unset()` function in the `rpc_soc(3NSL)` man page.

PMAPPROC_GETPORT

Given a program number *prog*, version number *vers*, and transport protocol number *prot*, this procedure returns the port number on which the program is awaiting call requests. A port value of zeros means the program has not been registered. The *port* field of the argument is ignored. See also the `pmap_getport()` function in the `rpc_soc(3NSL)` man page.

PMAPPROC_DUMP

This procedure enumerates all entries in the port mapper's database. The procedure takes no parameters and returns a list of program, version, protocol, and port values. See also the `pmap_getmaps()` function in the `rpc_soc(3NSL)` man page.

PMAPPROC_CALLIT

This procedure allows a caller to call another remote procedure on the same machine without knowing the remote procedure's port number. It is intended for supporting broadcasts to arbitrary remote programs via the well-known port mapper's port. The parameters *prog*, *vers*, *proc*, and the bytes of *args* are the program number, version number, procedure number, and parameters of the remote procedure. See also the `pmap_rmtcall()` function in the `rpc_soc(3NSL)` man page.

This procedure only sends a response if the procedure was successfully executed and is silent (no response) otherwise. It also returns the remote program's port number, and the bytes of *results* are the results of the remote procedure.

The port mapper communicates with the remote program using UDP/IP only.

Bibliography

1. Birrell, Andrew D. and Nelson, Bruce Jay; "Implementing Remote Procedure Calls"; *XEROX CSL-83-7*, October 1983.
2. Cheriton, D.; "VMTP: Versatile Message Transaction Protocol," Preliminary Version 0.3; Stanford University, January 1987.
3. Postel, J.; "Transmission Control Protocol - DARPA Internet Program Protocol Specification," *RFC 793*; Information Sciences Institute, September 1981.
4. Postel, J.; "User Datagram Protocol," *RFC 768*; Information Sciences Institute, August 1980.
5. Reynolds, J. & Postel, J.; "Assigned Numbers," *RFC 923*; Information Sciences Institute, October 1984.

Writing a Port Monitor With the Service Access Facility (SAF)

This appendix gives a brief description of the functions a port monitor must perform to run under the service access facility (SAF) and service access controller (SAC).

- “What Is the SAF” on page 307
- “What Is the SAC” on page 308
- “SAF Files” on page 311
- “The SAC/Port Monitor Interface” on page 312
- “The Port Monitor Administrative Interface” on page 314
- “Configuration Files and Scripts” on page 321
- “Sample Port Monitor Code” on page 325
- “Logic Diagram and Directory Structure” on page 331

What Is the SAF

The SAF generalizes the procedures for service access so that login access on the local system and network access to local services are managed in similar ways. Under the SAF, systems may access services using a variety of port monitors, including `ttymon`, the listener, and port monitors written expressly for a user’s application.

The manner in which a port monitor observes and manages access ports is specific to the port monitor and not to any component of the SAF. Users may therefore extend their systems by developing and installing their own port monitors. One of the important features of the SAF is that it can be extended in this way by users.

Relative to the SAF, a service is a process that is started. There are no restrictions on the functions a service may provide.

The SAF consists of a controlling process, the service access controller (SAC), and two administrative levels corresponding to two levels in the supporting directory structure. The top administrative level is concerned with port monitor administration, the lower level with service administration.

From an administrative point of view, the SAF consists of the following components:

- The SAC
- A per-system configuration script
- The SAC administrative file
- The SAC administrative command `sacadm`
- Port monitors
- Optional per-port monitor configuration scripts
- An administrative file (for each port monitor)
- The administrative command `pmadm`
- Optional per-service configuration scripts

What Is the SAC

The SAC is the SAF's controlling process. The SAC is started by `init()` by means of an entry in `/etc/inittab`. Its function is to maintain the port monitors on the system in the state specified by the system administrator.

The administrative command `sacadm` is used to tell the SAC to change the state of a port monitor. `sacadm` can also be used to add or remove a port monitor from SAC supervision and to list information about port monitors known to the SAC.

The SAC's administrative file contains a unique tag for each port monitor known to the SAC and the path name of the command used to start each port monitor.

The SAC performs three main functions:

- Customizes its own environment
- Starts the appropriate port monitors
- Polls its port monitors and initiates recovery procedures when necessary

Basic Port Monitor Functions

A *port monitor* is a process that is responsible for monitoring a set of homogeneous, incoming ports on a machine. A port monitor's major purpose is to detect incoming service requests and to dispatch them appropriately.

A *port* is an externally seen access point on a system. A port may be an address on a network (TSAP or PSAP), a hardwired terminal line, an incoming phone line, etc. The definition of what constitutes a port is strictly a function of the port monitor itself.

A port monitor performs certain basic functions. Some of these are required to conform to the SAF; others may be specified by the requirements and design of the port monitor itself.

Port monitors have two main functions:

- Managing ports
- Monitoring ports for indications of activity

Port Management

The first function of a port monitor is to manage a port. The actual details of how a port is managed are defined by the person who defines the port monitor. A port monitor is not restricted to handling a single port; it may handle multiple ports simultaneously.

Note - Some examples of port management are setting the line speed on incoming phone connections, binding an appropriate network address, reinitializing the port when the service terminates, outputting a prompt, etc.

Activity Monitoring

The second function of a port monitor is to monitor the port or ports for which it is responsible for indications of activity. Two types of activity may be detected.

1. The first is an indication to the port monitor to take some port monitor-specific action. Pressing the break key to indicate that the line speed should be cycled is an example of a port monitor activity. Not all port monitors need to recognize and respond to the same indications. The indication used to attract the attention of the port monitor is defined by the person who defines the port monitor.
2. The second is an incoming service request. When a service request is received, a port monitor must be able to determine which service is being requested from the port on which the request is received. Note that the same service may be available on more than one port.

Other Port Monitor Functions

This section briefly describes other port monitor functions.

Restricting Access to the System

A port monitor must be able to restrict access to the system without disturbing services that are still running. In order to do this, a port monitor must maintain two internal states: enabled and disabled. The port monitor starts in the state indicated by the `ISTATE` environment variable provided by the `sac`. See “The `SAC/Port Monitor Interface`” on page 312.

Enabling or disabling a port monitor affects all ports for which the port monitor is responsible. If a port monitor is responsible for a single port, only that port will be affected. If a port monitor is responsible for multiple ports, the entire collection of ports will be affected.

Enabling or disabling a port monitor is a dynamic operation: It causes the port monitor to change its internal state. The effect does not persist across new invocations of the port monitor.

Enabling or disabling an individual port, however, is a static operation: It causes a change to an administrative file. The effect of this change will persist across new invocations of the port monitor.

Creating `utmpx` Entries

Port monitors are responsible for creating `utmpx` entries with the `type` field set to `USER_PROCESS` for services they start, if this action has been specified (that is, if `-fu` was specified in the `pmadm` line that added the service). These `utmpx` entries may in turn be modified by the service. When the service terminates, the `utmpx` entry must be set to `DEAD_PROCESS`.

Port Monitor Process IDs and Lock Files

When a port monitor starts, it writes its process id into a file named `_pid` in the current directory and places an advisory lock on the file.

Changing the Service Environment: Running `doconfig()`

Before invoking the service designated in the port monitor administrative file, `_pmtab`, a port monitor must arrange for the per-service configuration script to be run (if one exists by calling the library function `doconfig()`). Because the per-service configuration script may specify the execution of restricted commands, as well as for other security reasons, port monitors are invoked with `root` permissions.

The details of how services are invoked are specified by the person who defines the port monitor.

Terminating a Port Monitor

A port monitor must terminate itself gracefully on receipt of the signal `SIGTERM`. The termination sequence is the following:

1. The port monitor enters the `stopping` state; no further service requests are accepted.
2. Any attempt to re-enable the port monitor will be ignored.
3. The port monitor yields control of all ports for which it is responsible. It must be possible for a new instantiation of the port monitor to start correctly while a previous instantiation is stopping.
4. The advisory lock on the process id file is released. Once this lock is released, the contents of the process id file are undefined and a new invocation of the port monitor may be started.

SAF Files

This section briefly covers the files used by the SAF.

The Port Monitor Administrative File

A port monitor's current directory contains an administrative file named `_pmtab`. `_pmtab` is maintained by the `pmadm` command in conjunction with a port monitor-specific administrative command.

Note - The port monitor administrative command for a `listen` port monitor is `nlsadmin()`; the port monitor administrative command for `ttymon` is `ttyadm()`. Any port monitor written by a user must be provided with an administrative command specific to that port monitor to perform similar functions.

Per-Service Configuration Files

A port monitor's current directory also contains the per-service configuration scripts, if they exist. The names of the per-service configuration scripts correspond to the service tags in the `_pmtab` file.

Private Port Monitor Files

A port monitor may create private files in the directory `/var/saf/tag`, where *tag* is the name of the port monitor. Examples of private files are log files or temporary files.

The SAC/Port Monitor Interface

The `sac` creates two environment variables for each port monitor it starts:

1. `PMTAG`
2. `ISTATE`

This variable is set to a unique port monitor tag by the `sac`. The port monitor uses this tag to identify itself in response to `sac` messages. `ISTATE` is used to indicate to the port monitor what its initial internal state should be. `ISTATE` is set to "enabled" or "disabled" to indicate that the port monitor is to start in the enabled or disabled state respectively. The `sac` performs a periodic sanity poll of the port monitors.

The `sac` communicates with port monitors through `FIFOs`. A port monitor should open `_pmpipe`, in the current directory, to receive messages from the `sac` and `../_sacpipe` to send return messages to the `sac`.

Message Formats

This section describes the messages that may be sent from the `sac` to a port monitor (`sac` messages), and from a port monitor to the `sac` (port monitor messages). These messages are sent through `FIFOs` and are in the form of C structures. See Code Example F-2.

`sac` Messages

The format of messages from the `sac` is defined by the structure `sacmsg`:

```

struct sacmsg {
    int sc_size; /* size of optional data portion */
    char sc_type; /* type of message */
};

```

The `sac` may send four types of messages to port monitors. The type of message is indicated by setting the `sc_type` field of the `sacmsg` structure to one of the following:

`SC_STATUS` status request `SC_ENABLE` enable message `SC_DISABLE` disable message `SC_READDB` message indicating that the port monitor's `_pmtab` file should be read

`sc_size` indicates the size of the optional data part of the message. See "Message Classes" on page 314. For Solaris, `sc_size` should always be set to 0.

A port monitor must respond to every message sent by the `sac`.

Port Monitor Messages

The format of messages from a port monitor to the `sac` is defined by the structure `pmmsg`:

```

struct pmmsg {
    char pm_type; /* type of message */
    uchar pm_state; /* current state of port monitor */
    char pm_maxclass; /* maximum message class this port
                       monitor understands */
    char pm_tag[PMTAGSIZE + 1]; /* port monitor's tag */
    int pm_size; /* size of optional data portion */
};

```

Port monitors may send two types of messages to the `sac`. The type of message is indicated by setting the `pm_type` field of the `pmmsg` structure to one of the following:

`PM_STATUS` state information `PM_UNKNOWN` negative acknowledgment

For both types of messages, the `pm_tag` field is set to the port monitor's tag and the `pm_state` field is set to the port monitor's current state. Valid states are:

`PM_STARTING` starting `PM_ENABLED` enabled `PM_DISABLED` disabled
`PM_STOPPING` stopping

The current state reflects any changes caused by the last message from the `sac`.

The status message is the normal return message. The negative acknowledgment should be sent only when the message received is not understood.

`pm_size` indicates the size of the optional data part of the message. `pm_maxclass` is used to specify a message class. Both are discussed under "Message Classes" on page 314. In Solaris, always set `pm_maxclass` to 1 and `sc_size` to 0.

Port monitors may never initiate messages; they may only respond to messages that they receive.

Message Classes

The concept of message class has been included to accommodate possible SAF extensions. The messages described above are all `class 1` messages. None of these messages contains a variable data portion; all pertinent information is contained in the message header.

If new messages are added to the protocol, they will be defined as new message classes (for example, `class 2`). The first message the `sac` sends to a port monitor will always be a `class 1` message. Since all port monitors, by definition, understand `class 1` messages, the first message the `sac` sends is guaranteed to be understood. In its response to the `sac`, the port monitor sets the `pm_maxclass` field to the maximum message class number for that port monitor. The `sac` will not send messages to a port monitor from a class with a larger number than the value of `pm_maxclass`. Requests that require messages of a higher class than the port monitor can understand will fail. For Solaris, always set `pm_maxclass` to 1.

Note - For any given port monitor, messages of class `pm_maxclass` and messages of all classes with values lower than `pm_maxclass` are valid. Thus, if the `pm_maxclass` field is set to 3, the port monitor understands messages of classes 1, 2, and 3. Port monitors may not generate messages; they may only respond to messages. A port monitor's response must be of the same class as the originating message.

Since only the `sac` can generate messages, this protocol will function even if the port monitor is capable of dealing with messages of a higher class than the `sac` can generate.

`pm_size` (an element of the `pmmsg` structure) and `sc_size` (an element of the `sacmsg` structure) indicate the size of the optional data part of the message. The format of this part of the message is undefined. Its definition is inherent in the type of message. For Solaris, always set both `sc_size` and `pm_size` to 0.

The Port Monitor Administrative Interface

This section discusses the administrative files available under the `SAC`.

The SAC Administrative File `_sactab`

The service access controller's administrative file contains information about all the port monitors for which the SAC is responsible. This file exists on the delivered system. Initially, it is empty except for a single comment line that contains the version number of the SAC. Port monitors are added to the system by making entries in the SAC's administrative file. These entries should be made using the administrative command `sacadm` with a `-a` option. `sacadm` is also used to remove entries from the SAC's administrative file.

Each entry in the SAC's administrative file contains the following information, shown in Table F-1.

TABLE F-1 Service Access Controller `_sactab` File

Fields	Description
PMTAG	A unique tag that identifies a particular port monitor. The system administrator is responsible for naming a port monitor. This tag is then used by the SAC to identify the port monitor for all administrative purposes. <code>PMTAG</code> may consist of up to 14 alphanumeric characters.
PMTYPE	The type of the port monitor. In addition to its unique tag, each port monitor has a type designator. The type designator identifies a group of port monitors that are different invocations of the same entity. <code>ttymon</code> and <code>listen</code> are examples of valid port monitor types. The type designator is used to facilitate the administration of groups of related port monitors. Without a type designator, the system administrator has no way of knowing which port monitor tags correspond to port monitors of the same type. <code>PMTYPE</code> may consist of up to 14 alphanumeric characters.
FLGS	The flags that are currently defined are: <code>-d</code> When started, do not enable the port monitor. <code>-x</code> Do not start the port monitor. If no flag is specified, the default action is taken. By default a port monitor is started and enabled.
RCNT	The number of times a port monitor may fail before being placed in a failed state. Once a port monitor enters the failed state, the SAC will not try to restart it. If a count is not specified when the entry is created, this field is set to 0. A restart count of 0 indicates that the port monitor is not to be restarted when it fails.
COMMAND	A string representing the command that will start the port monitor. The first component of the string, the command itself, must be a full path name.

The Port Monitor Administrative File `_pmtab`

Each port monitor will have two directories for its exclusive use. The current directory will contain files defined by the SAF (`_pmtab`, `_pid`) and the per-service

configuration scripts, if they exist. The directory `/var/saf/pmtag`, where *pmtag* is the tag of the port monitor, is available for the port monitor's private files.

Each port monitor has its own administrative file. The `pmadm` command should be used to add, remove, or modify service entries in this file. Each time a change is made using `pmadm`, the corresponding port monitor rereads its administrative file. Each entry in a port monitor's administrative file defines how the port monitor treats a specific port and what service is to be invoked on that port.

Some fields must be present for all types of port monitors. Each entry must include a service tag to identify the service uniquely and an identity to be assigned to the service when it is started (for example, `root`).

Note - The combination of a service tag and a port monitor tag uniquely define an instance of a service. The same service tag may be used to identify a service under a different port monitor. The record must also contain port monitor specific data (for example, for a `ttymon` port monitor, this will include the prompt string which is meaningful to `ttymon`). Each type of port monitor must provide a command that takes the necessary port monitor-specific data as arguments and outputs these data in a form suitable for storage in the file. The `ttyadm` command does this for `ttymon` and `nlsadmin` does it for `listen`. For a user-defined port monitor, a similar administrative command must also be supplied.

Each service entry in the port monitor administrative file must have the following format and contain the information listed below:

```
svctag:flgs:id:reserved:reserved:reserved:pmspecific# comment
```

SVCTAG is a unique tag that identifies a service. This tag is unique only for the port monitor through which the service is available. Other port monitors may offer the same or other services with the same tag. A service requires both a port monitor tag and a service tag to identify it uniquely.

SVCTAG may consist of up to 14 alphanumeric characters. The service entries are defined in Table F-2.

TABLE F-2 SVCTAG Service Entries

Service Entries	Description
FLGS	Flags with the following meanings may currently be included in this field: -x Do not enable this port. By default the port is enabled. -u Create a <code>utmpx</code> entry for this service. By default no <code>utmpx</code> entry is created for the service.
ID	The identity under which the service is to be started. The identity has the form of a login name as it appears in <code>/etc/passwd</code> .

TABLE F-2 SVCTAG Service Entries (continued)

Service Entries	Description
PMSPECIFIC	Examples of port monitor information are addresses, the name of a process to execute, or the name of a STREAMS pipe to pass a connection through. This information will vary to meet the needs of each different type of port monitor.
COMMENT	A comment associated with the service entry.

Note - Port monitors may ignore the `-u` flag if creating a `utmpx` entry for the service is not appropriate to the manner in which the service is to be invoked. Some services may not start properly unless `utmpx` entries have been created for them (for example, `login`).

Each port monitor administrative file must contain one special comment of the form:

```
# VERSION=value
```

where *value* is an integer that represents the port monitor's version number. The version number defines the format of the port monitor administrative file. This comment line is created automatically when a port monitor is added to the system. It appears on a line by itself, before the service entries.

The SAC Administrative Command `sacadm`

`sacadm` is the administrative command for the upper level of the SAF hierarchy, that is, for port monitor administration (see the `sacadm(1M)` manpage). Under the SAF, port monitors are administered by using the `sacadm` command to make changes in the SAC's administrative file. `sacadm` performs the following functions:

- Prints requested port monitor information from the SAC administrative file
- Adds or removes a port monitor
- Enables or disables a port monitor
- Starts or stops a port monitor
- Installs or replaces a per-system configuration script
- Installs or replaces a per-port monitor configuration script
- Asks the SAC to reread its administrative file

The Port Monitor Administrative Command

`pmadm`

`pmadm` is the administrative command for the lower level of the `SAF` hierarchy, that is, for service administration (see the `pmadm(1M)` manpage). A port may have only one service associated with it although the same service may be available through more than one port. `pmadm` performs the following functions:

- Prints service status information from the port monitor's administrative file
- Adds or removes a service
- Enables or disables a service
- Installs or replaces a per-service configuration script

Note that in order to identify an instance of a service uniquely, the `pmadm` command must identify both the service (`-s`) and the port monitor or port monitors through which the service is available (`-p` or `-t`).

Monitor-Specific Administrative Command

In the previous section, two pieces of information included in the `_pmtab` file were described: the port monitor's version number and the port monitor part of the service entries in the port monitor's `_pmtab` file. When a new port monitor is added, the version number must be known so that the `_pmtab` file can be correctly initialized. When a new service is added, the port monitor part of the `_pmtab` entry must be formatted correctly.

Each port monitor must have an administrative command to perform these two tasks. The person who defines the port monitor must also define such an administrative command and its input options. When the command is invoked with these options, the information required for the port monitor part of the service entry must be correctly formatted for inclusion in the port monitor's `_pmtab` file and must be written to the standard output. To request the version number the command must be invoked with a `-v` option; when it is invoked in this way, the port monitor's current version number must be written to the `standard output`.

If the command fails for any reason during the execution of either of these tasks, no data should be written to `standard output`.

The Port Monitor/Service Interface

The interface between a port monitor and a service is determined solely by the service. Two mechanisms for invoking a service are presented here as examples.

New Service Invocations

The first interface is for services that are started anew with each request. This interface requires the port monitor to first `fork()` a child process. The child will eventually become the designated service by performing an `exec()`. Before the `exec()` happens, the port monitor may take some port monitor-specific action; however, one action that must occur is the interpretation of the per-service configuration script, if one is present. This is done by calling the library routine `doconfig()`.

Standing Service Invocations

The second interface is for invocations of services that are actively running. To use this interface, a service must have one end of a `stream` pipe open and be prepared to receive connections through it.

Port Monitor Requirements

To implement a port monitor, several generic requirements must be met. This section summarizes these requirements. In addition to the port monitor itself, an administrative command must be supplied.

Initial Environment

When a port monitor is started, it expects an initial execution environment in which:

- It has no file descriptors open
- It cannot be a process group leader
- It has an entry in `/var/admin/utmpx` of type `LOGIN_PROCESS`
- An environment variable, `ISTATE`, is set to “enabled” or “disabled” to indicate the port monitor’s correct initial state
- An environment variable, `PMTAG`, is set to the port monitor’s assigned tag
- The directory that contains the port monitor’s administrative files is its current directory
- The port monitor is able to create private files in the directory `/var/saf/tag`, where `tag` is the port monitor’s tag
- The port monitor is running with user id 0 (`root`)

Important Files

Relative to its current directory, the following key files exist for a port monitor.

TABLE F-3 Key Port Monitor Files

File	Description
<code>_config</code>	The port monitor's configuration script. The port monitor configuration script is run by the SAC. The SAC is started by <code>init()</code> as a result of an entry in <code>/etc/inittab</code> that calls <code>sac</code> .
<code>_pid</code>	The file into which the port monitor writes its process id.
<code>_pmtab</code>	The port monitor's administrative file. This file contains information about the ports and services for which the port monitor is responsible.
<code>_pmpipe</code>	The FIFO through which the port monitor will receive messages from <code>sac</code> .
<code>svctag</code>	The per-service configuration script for the service with the tag <code>svctag</code> .
<code>../_sacpipe</code>	The FIFO through which the port monitor will send messages to <code>sac</code> .

Port Monitor Responsibilities

A port monitor is responsible for performing the following tasks in addition to its port monitor function:

- Write its process id into the file `_pid` and place an advisory lock on the file
- Terminate gracefully on receipt of the signal `SIGTERM`.
- Follow the protocol for message exchange with `sac`

A port monitor must perform the following tasks during service invocation:

- Create a `utmp` entry if the requested service has the “-u” flag set in `_pmtab`

Note - Port monitors may ignore this flag if creating a `utmp` entry for the service does not make sense because of the manner in which the service is to be invoked. On the other hand, some services may not start properly unless `utmp` entries have been created for them.

- Interpret the per-service configuration script for the requested service, if it exists, by calling the `doconfig()` library routine

Configuration Files and Scripts

Interpreting Configuration Scripts With `doconfig()`

The library routine `doconfig()`, defined in `libnsl.so`, interprets the configuration scripts contained in the files `/etc/saf/_sysconfig` (the per-system configuration file), and `/etc/saf/pmtag/_config` (per-port monitor configuration files); and in `/etc/saf/pmtag/svctag` (per-service configuration files). Its syntax is:

```
# include <sac.h>
int doconfig (int fd, char *script, long rflag);
```

script is the name of the configuration script; *fd* is a file descriptor that designates the stream to which stream manipulation operations are to be applied; *rflag* is a bitmask that indicates the mode in which *script* is to be interpreted. *rflag* may take two values, `NORUN` and `NOASSIGN`, which may be or'd. If *rflag* is zero, all commands in the configuration script are eligible to be interpreted. If *rflag* has the `NOASSIGN` bit set, the `assign` command is considered illegal and will generate an error return. If *rflag* has the `NORUN` bit set, the `run` and `runwait` commands are considered illegal and will generate error returns.

If a command in the script fails, the interpretation of the script ceases at that point and a positive integer is returned; this number indicates which line in the script failed. If a system error occurs, a value of `-1` is returned.

If a script fails, the process whose environment was being established should *not* be started.

In the example, `doconfig()` is used to interpret a per-service configuration script.

```
. . .
    if ((i = doconfig (fd, svctag, 0)) != 0){
        error ("doconfig failed online %d of script %s",i,svctag);
    }
```

The Per-System Configuration File

The per-system configuration file, `/etc/saf/_sysconfig`, is delivered empty. It may be used to customize the environment for all services on the system by writing a command script in the interpreted language described in this chapter and on the `doconfig(3NSL)` man page. When the SAC is started, it calls the `doconfig()` function to interpret the per-system configuration script. The SAC is started when the system enters multiuser mode.

Per-Port Monitor Configuration Files

Per-port monitor configuration scripts (`/etc/saf/pmtag/_config`) are optional. They allow the user to customize the environment for any given port monitor and for the services that are available through the ports for which that port monitor is responsible. Per-port monitor configuration scripts are written in the same language used for per-system configuration scripts.

The per-port monitor configuration script is interpreted when the port monitor is started. The port monitor is started by the SAC after the SAC has itself been started and after it has run its own configuration script, `/etc/saf/_sysconfig`.

The per-port monitor configuration script may override defaults provided by the per-system configuration script.

Per-Service Configuration Files

Per-service configuration files allow the user to customize the environment for a specific service. For example, a service may require special privileges that are not available to the general user. Using the language described in the `doconfig(3NSL)` man page, you can write a script that will grant or limit such special privileges to a particular service offered through a particular port monitor.

The per-service configuration may override defaults provided by higher-level configuration scripts. For example, the per-service configuration script may specify a set of `STREAMS` modules other than the default set.

The Configuration Language

The language in which configuration scripts are written consists of a sequence of commands, each of which is interpreted separately. The following reserved keywords are defined: `assign`, `push`, `pop`, `runwait`, and `run`. The comment character is `#`. Blank lines are not significant. No line in a command script may exceed 1024 characters.

```
assign variable=value
```

Used to define environment variables. *variable* is the name of the environment variable and *value* is the value to be assigned to it. The value assigned must be a string constant; no form of parameter substitution is available. *value* may be quoted. The quoting rules are those used by the shell for defining environment variables. `assign` will fail if space cannot be allocated for the new variable or if any part of the specification is invalid.

```
push module1 [  
module2, module3, ...]
```

Used to push STREAMS modules onto the stream designated by *fd*. See the `doconfig(3NSL)` man page. *module1* is the name of the first module to be pushed, *module2* is the name of the second module to be pushed, and so on. The command will fail if any of the named modules cannot be pushed. If a module cannot be pushed, the subsequent modules on the same command line will be ignored and modules that have already been pushed will be popped.

```
pop [module]
```

Used to pop STREAMS modules off the designated stream. If `pop` is invoked with no arguments, the top module on the stream is popped. If an argument is given, modules will be popped one at a time until the named module is at the top of the stream. If the named module is not on the designated stream, the stream is left as it was and the command fails. If *module* is the special keyword `ALL`, then all modules on the stream will be popped. Note that only modules above the topmost driver are affected.

```
runwait command
```

The `runwait` command runs a command and waits for it to complete. `command` is the path name of the command to be run. The command is run with `/bin/sh -c` prepended to it; shell scripts may thus be executed from configuration scripts. The `runwait` command will fail if `command` cannot be found or cannot be executed, or if `command` exits with a nonzero status.

```
run command
```

The `run` command is identical to `runwait` except that it does not wait for `command` to complete. `command` is the path name of the command to be run. `run` will not fail unless it is unable to create a child process to execute the command.

Although they are syntactically indistinguishable, some of the commands available to `run` and `runwait` are interpreter built-in commands. Interpreter built-ins are used when it is necessary to alter the state of a process within the context of that process. The `doconfig()` interpreter built-in commands are similar to the shell special commands and, like these, they do not spawn another process for execution. See the `sh(1)` man page. The initial set of built-in commands is:

```
cd ulimit umask
```

Printing, Installing, and Replacing Configuration Scripts

This section describes the form of the SAC and port monitor administrative commands used to install the three types of configuration scripts. Per-system and

per-port monitor configuration scripts are administered using the `sacadm` command. Per-service configuration scripts are administered using the `pmadm` command.

Per-System Configuration Scripts

```
sacadm -G [ -z script ]
```

The `-G` option is used to print or replace the per-system configuration script. The `-G` option by itself prints the per-system configuration script. The `-G` option in combination with a `-z` option replaces `/etc/saf/_sysconfig` with the contents of the file `script`. Other combinations of options with a `-G` option are invalid.

Sample Per-System Configuration Script

The `_sysconfig` file in the example sets the time zone variable, `TZ`.

```
assign TZ=EST5EDT # set TZ
runwait echo SAC is starting > /dev/console
```

Per-Port Monitor Configuration Scripts

```
sacadm -g -p pmtag [ -z script ]
```

The `-g` option is used to print, install, or replace the per-port monitor configuration script. A `-g` option requires a `-p` option. The `-g` option with only a `-p` option prints the per-port monitor configuration script for port monitor `pmtag`. The `-g` option with a `-p` option and a `-z` option installs the file `script` as the per-port monitor configuration script for port monitor `pmtag`, or, if `/etc/saf/pmtag/_config` exists, it replaces `_config` with the contents of `script`. Other combinations of options with `-g` are invalid.

Sample Per-Port Monitor Configuration Script

In the hypothetical `_config` file in the figure, the command `/usr/bin/daemon` is assumed to start a daemon process that builds and holds together a STREAMS multiplexor. By installing this configuration script, the command can be executed just before starting the port monitor that requires it.

```
# build a STREAMS multiplexor
run /usr/bin/daemon
runwait echo $PMTAG is starting > /dev/console
```

Per-Service Configuration Scripts

```
pmadm -g -p pmtag -s svctag [ -z script ]
pmadm -g -s svctag -t type -z script
```

Per-service configuration scripts are interpreted by the port monitor before the service is invoked.

Note - The SAC interprets both its own configuration file, `_sysconfig`, and the port monitor configuration files. Only the per-service configuration files are interpreted by the port monitors.

The `-g` option is used to print, install, or replace a per-service configuration script. The `-g` option with a `-p` option and a `-s` option prints the per-service configuration script for service `svctag` available through port monitor `pmtag`. The `-g` option with a `-p` option, a `-s` option, and a `-z` option installs the per-service configuration script contained in the file `script` as the per-service configuration script for service `svctag` available through port monitor `pmtag`. The `-g` option with a `-s` option, a `-t` option, and a `-z` option installs the file `script` as the per-service configuration script for service `svctag` available through any port monitor of type `type`. Other combinations of options with `-g` are invalid.

Sample Per-Service Configuration Script

The following per-service configuration script does two things: It specifies the maximum file size for files created by a process by setting the process's `ulimit` to 4096. It also specifies the protection mask to be applied to files created by the process by setting `umask` to 077.

```
runwait ulimit 4096
runwait umask 077
```

Sample Port Monitor Code

Code Example F-1 shows an example of a “null” port monitor that simply responds to messages from the SAC.

CODE EXAMPLE F-1 Sample Port Monitor

```
# include <stdlib.h>
# include <stdio.h>
# include <unistd.h>
# include <fcntl.h>
# include <signal.h>
# include <sac.h>

char Scratch[BUFSIZ]; /* scratch buffer */
```

(continued)

(Continuation)

```
char Tag[PMTAGSIZE + 1]; /* port monitor's tag */
FILE *Fp; /* file pointer for log file */
FILE *Tfp; /* file pointer for pid file */
char State; /* port monitor's current state*/

main(argc, argv)
int argc;
char *argv[];
{
    char *istate;
    strcpy(Tag, getenv("PMTAG"));
    /*
    * open up a log file in port monitor's private directory
    */
    sprintf(Scratch, "/var/saf/%s/log", Tag);
    Fp = fopen(Scratch, "a+");
    if (Fp == (FILE *)NULL)
        exit(1);
    log(Fp, "starting");
    /*
    * retrieve initial state (either "enabled" or "disabled") and set
    * State accordingly
    */
    istate = getenv("ISTATE");
    sprintf(Scratch, "ISTATE is %s", istate);
    log(Fp, Scratch);
    if (!strcmp(istate, "enabled"))
        State = PM_ENABLED;
    else if (!strcmp(istate, "disabled"))
        State = PM_DISABLED;
    else {
        log(Fp, "invalid initial state");
        exit(1);
    }
    sprintf(Scratch, "PMTAG is %s", Tag);
    log(Fp, Scratch);
    /*
    * set up pid file and lock it to indicate that we are active
    */
    Tfp = fopen("_pid", "w");
    if (Tfp == (FILE *)NULL) {
        log(Fp, "couldn't open pid file");
        exit(1);
    }
    if (lockf(fileno(Tfp), F_TEST, 0) < 0) {
        log(Fp, "pid file already locked");
        exit(1);
    }
    fprintf(Tfp, "%d", getpid());
    fflush(Tfp);
    log(Fp, "locking file");
    if (lockf(fileno(Tfp), F_LOCK, 0) < 0) {
```

(continued)

(Continuation)

```
    log(Fp, "lock failed");
    exit(1);
}
/*
 * handle poll messages from the sac ... this function never
returns
 */
handlepoll();
pause();
fclose(Tfp);
fclose(Fp);
}

handlepoll()
{
    int pfd; /* file descriptor for incoming pipe */
    int sfd; /* file descriptor for outgoing pipe */
    struct sacmsg sacmsg; /* incoming message */
    struct pmmsg pmmsg; /* outgoing message */
    /*
     * open pipe for incoming messages from the sac
     */
    pfd = open("_pmpipe", O_RDONLY|O_NONBLOCK);
    if (pfd < 0) {
        log(Fp, "_pmpipe open failed");
        exit(1);
    }
    /*
     * open pipe for outgoing messages to the sac
     */
    sfd = open("../_sacpipe", O_WRONLY);
    if (sfd < 0) {
        log(Fp, "_sacpipe open failed");
        exit(1);
    }
    /*
     * start to build a return message; we only support class 1
messages
     */
    strcpy(pmmsg.pm_tag, Tag);
    pmmsg.pm_size = 0;
    pmmsg.pm_maxclass = 1;
    /*
     * keep responding to messages from the sac
     */
    for (;;) {
        if (read(pfd, &sacmsg, sizeof(sacmsg)) != sizeof(sacmsg)) {
            log(Fp, "_pmpipe read failed");
            exit(1);
        }
    }
    /*
     * determine the message type and respond appropriately
     */
}
```

(continued)

(Continuation)

```
switch (sacmsg.sc_type) {
case SC_STATUS:
    log(Fp, "Got SC_STATUS message");
    pmmsg.pm_type = PM_STATUS;
    pmmsg.pm_state = State;
    break;
case SC_ENABLE:
    /*note internal state change below*/
    log(Fp, "Got SC_ENABLE message");
    pmmsg.pm_type = PM_STATUS;
    State = PM_ENABLED;
    pmmsg.pm_state = State;
    break;
case SC_DISABLE:
    /*note internal state change below*/
    log(Fp, "Got SC_DISABLE message");
    pmmsg.pm_type = PM_STATUS;
    State = PM_DISABLED;
    pmmsg.pm_state = State;
    break;
case SC_READDB:
    /*
     * if this were a fully functional port monitor it
     * would read _pmtab here and take appropriate action
     */
    log(Fp, "Got SC_READDB message");
    pmmsg.pm_type = PM_STATUS;
    pmmsg.pm_state = State;
    break;
default:
    sprintf(Scratch, "Got unknown message <%d>",
        sacmsg.sc_type);
    log(Fp, Scratch);
    pmmsg.pm_type = PM_UNKNOWN;
    pmmsg.pm_state = State;
    break;
}
/*
 * send back a response to the poll
 * indicating current state
 */
if (write(sfd, &pmmsg, sizeof(pmmsg)) != sizeof(pmmsg))
    log(Fp, "sanity response failed");
}
/*
 * general logging function
 */
log(fp, msg)
FILE *fp;
char *msg;
{
```

(continued)

(Continuation)

```
fprintf(fp, "%d; %s\n", getpid(), msg);
fflush(fp);
}
```

Code Example F-2 shows the `sac.h` header file.

CODE EXAMPLE F-2 `sac.h` Header File

```
/* length in bytes of a utmpx id */
# define IDLEN 4
/* wild character for utmpx ids */
# define SC_WILDC 0xff
/* max len in bytes for port monitor tag */
# define PMTAGSIZE 14
/*
 * values for rflag in doconfig()
 */
/* don't allow assign operations */
# define NOASSIGN 0x1
/* don't allow run or runwait operations */
# define NORUN 0x2
/*
 * message to SAC (header only). This header is forever fixed. The
 * size field (pm_size) defines the size of the data portion of
 the
 * message, which follows the header. The form of this optional
 data
 * portion is defined strictly by the message type (pm_type).
 */
struct pmmsg {
    char pm_type;           /* type of message */
    uchar pm_state;        /* current state of pm */
    char pm_maxclass;      /* max message class this port
monitor
                        understands */
    char pm_tag[PMTAGSIZE + 1]; /* pm's tag */
    int pm_size;           /* size of opt data portion */
};
/*
 * pm_type values
 */
# define PM_STATUS 1 /* status response */
# define PM_UNKNOWN 2 /* unknown message was received */
/*
 * pm_state values
 */
/*
```

(continued)

(Continuation)

```
* Class 1 responses
*/
# define PM_STARTING 1 /* monitor in starting state */
# define PM_ENABLED 2 /* monitor in enabled state */
# define PM_DISABLED 3 /* monitor in disabled state */
# define PM_STOPPING 4 /* monitor in stopping state */
/*
 * message to port monitor
 */
struct sacmsg {
    int sc_size; /* size of optional data portion */
    char sc_type; /* type of message */
};
/*
 * sc_type values
 * These represent commands that the SAC sends to a port monitor.
 * These commands are divided into "classes" for extensibility.
Each
 * subsequent "class" is a superset of the previous "classes" plus
 * the new commands defined within that "class". The header for
all
 * commands is identical; however, a command may be defined such
that
 * an optional data portion may be sent in addition to the header.
 * The format of this optional data piece is self-defining based
on
 * the command. Important note:the first message sent by the SAC
will
 * always be a class 1 message. The port monitor response
indicates
 * the maximum class that it is able to understand. Another note
is
 * that port monitors should only respond to a message with an
 * equivalent class response (i.e. a class 1 command causes a
class 1
 * response).
*/
/*
 * Class 1 commands (currently, there are only class 1 commands)
*/
# define SC_STATUS 1 /* status request */
# define SC_ENABLE 2 /* enable request */
# define SC_DISABLE 3 /* disable request */
# define SC_READDB 4 /* read pmtab request */
/*
 * 'errno' values for Saferrno, note that Saferrno is used by both
 * pmadm and sacadm and these values are shared between them
*/
# define E_BADARGS 1 /* bad args/ill-formed cmd line */
# define E_NOPRIV 2 /* user not priv for operation */
# define E_SAFERR 3 /* generic SAF error */
# define E_SYSERR 4 /* system error */
```

(continued)

(Continuation)

```
# define E_NOEXIST 5 /* invalid specification */
# define E_DUP 6 /* entry already exists */
# define E_PMRUN 7 /* port monitor is running */
# define E_PMNOTRUN 8 /* port monitor is not running */
# define E_RECOVER 9 /* in recovery */
```

Logic Diagram and Directory Structure

Figure F-2 is a logical diagram of the SAF. It illustrates how a single service access controller may spawn a number of port monitors on a per-system basis. This means that several monitors may be running concurrently, providing for the simultaneous operation of several different protocols.

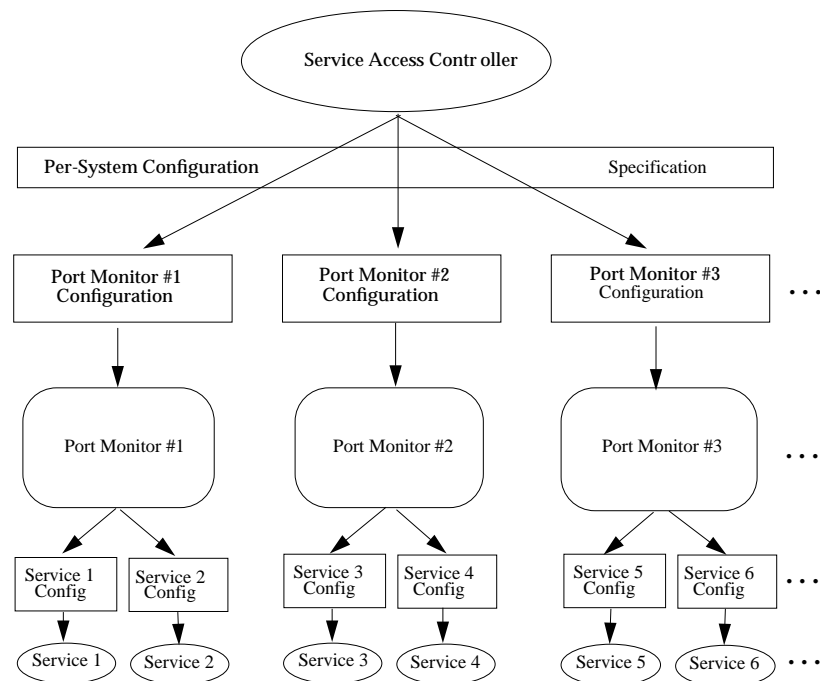

Figure F-1 SAF Logical Framework

“/etc/saf/_sysconfig” on page 332 is the corresponding directory structure diagram. Following the diagram is a description of the files and directories.

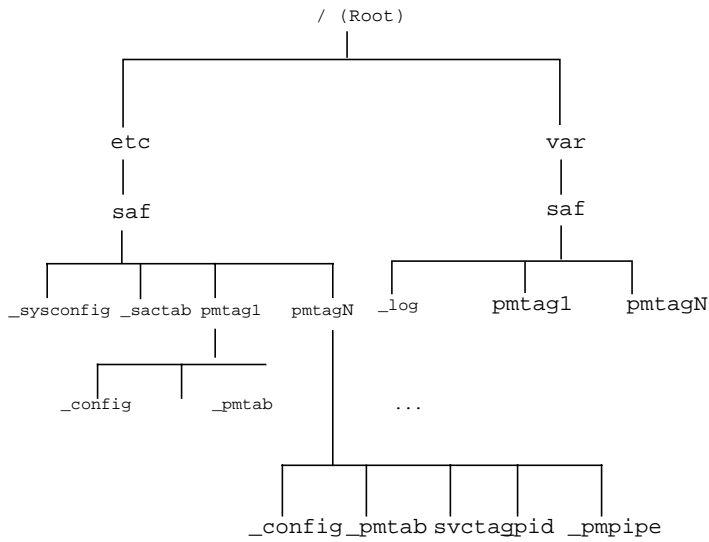

Figure F-2 SAF Directory Structure

/etc/saf/_sysconfig

The per-system configuration script.

/etc/saf/_sactab

The SAC’s administrative file. Contains information about the port monitors for which the SAC is responsible.

/etc/saf/pmtag

The home directory for port monitor *pmtag*.

/etc/saf/pmtag/_config

The per-port monitor configuration script for port monitor *pmtag*.

`/etc/saf/pmtag/_pmtab`

Port monitor *pmtag*'s administrative file. Contains information about the services for which *pmtag* is responsible.

`/etc/saf/pmtag/svctag`

The file in which the per-service configuration script for service *svctag* (available through port monitor *pmtag*) is placed.

`/etc/saf/pmtag/_pid`

The file in which a port monitor writes its process id in the current directory and places an advisory lock on the file.

`/etc/saf/pmtag/_pmpipe`

The file in which the port monitor receives messages from the *sac* and `../_sacpipe` and sends return messages to the *sac*.

`/var/saf/_log`

The *SAC*'s log file.

`/var/saf/pmtag`

The directory for files created by port monitor *pmtag*, for example its log file.

Glossary

RPC Programming Terms

The following terms define the RPC concepts used throughout this manual.

client	A program or system that uses the services of a remote program or system.
client handle	A client process data structure that represents the binding of the client to a particular server's RPC program.
connection-oriented transport	See <i>stream transport</i> .
connectionless transport	See <i>datagram transport</i> .
datagram transport	Datagram transports have less overhead than connection-oriented transports but are considered less reliable and data transmissions are limited by buffer size.
deserialize	Convert data from XDR format to a machine-specific representation.
handle	An abstraction used by the service libraries to refer to a file or a file-like object such as a socket.
host	A computer (mainframe, mini, server, workstation, or personal computer) connected to a network.
MT hot	An interface is multithreaded hot if the library or call automatically creates threads.
MT safe	An interface is multithreaded safe if it can be called in a threaded environment. An MT-safe interface may be invoked concurrently for multiple threads.

network client	Usually client. A process that makes remote procedure calls to services.
network server	Usually server. A process that performs a network service. A server may support more than one version of a remote program to be forward compatible with changing protocols.
network service	A collection of one or more remote service programs.
ping	The <code>ping</code> service is used to verify activity on a remote system.
remote program	A program that implements one or more remote procedures.
RPC Language (RPCL)	A C-like programming language translated by the <code>rpcgen</code> compiler. RPCL is a superset of XDR Language.
RPC library	<code>libnsl</code> , specified to the link editor at compile time. Also known as the RPC package.
RPC protocol	The message-passing protocol that is the basis of the RPC package.
RPC/XDR	See <i>RPC Language</i> .
serialize	Converting data from a machine representation to XDR format.
server	A process that provides remote service to clients.
stream transport	Stream transport is considered reliable. It supports byte-stream deliveries of unlimited data size.
transport	The fourth layer of the Open Systems Interconnection (OSI) Reference Model.
transport handle	An abstraction used by the RPC libraries to refer to the transport's data structures.
TI-RPC	Transport-independent RPC. The version of RPC supported in SunOS 5.x.
TS-RPC	Transport-specific RPC. The version of RPC supported in SunOS 4.x. TS-RPC is also supported in SunOS 5.x.
universal address	A machine-independent representation of a transport address.

**virtual circuit
transport
XDR Language**

See *streamtransport*.

A data description language and data representation protocol.

Index

Special Characters

% preprocessing directive 55
&, server invocation and 49

Numbers

_1 suffix 46, 81
32-bit system, *see* 64-bit system
64-bit system
 long vs. int 75
 rpcgen 74
 rpcproc_t 74
 rpcprog_t 74
 rpcvers_t 74

A

access control
 authentication vs. 114
 port monitors and 310
add.x source file 57, 58, 60, 64, 66, 67
adding
 address registrations 39
 NIS+ database entries 178
 NIS+ group members 177
 NIS+ objects to namespace 176
 NIS+ table entry objects 176, 187, 188
 port monitor services 316
 port monitors 308
 two numbers 292
ADDPROG program 292
addresses
 information reporting for 40
 lookup services 35, 38, 39

 management functions 163
 name-to-address translation routines 38,
 39, 160
 network 301, 302
 overview 301, 302
 passing arguments as 46, 81
 passing server's address to client 93
 passing user's bind address 96
 transport (netbuf) 39, 258
 universal 38, 257, 258, 301, 336
 unregistering
 current vs. previous release 162
 portmap routine 305
 rpcbind routine 39, 254, 257
 rpcinfo routine 40
addresses, *see* portmap routine
 mapping RPC services to
 registering
ah_cred field 100
ah_key field 115
ah_verf field 100
allocating memory, *see* memory\x0d
ampersand (&), server invocation and 49
ANSI C standards
 rpcgen tool and 43, 56, 67
application programming interface (API)
 NIS+ 175, 180
applications
 porting from TS-RPC to TI-RPC 158
arguments (remote procedures)
 overview 31
 passing arbitrary data types 82, 86
 passing by address 46, 81

- passing by value 58, 60
 - passing open TLI file descriptors 93, 96
 - passing server's address to client 93
 - passing user's bind address 96
 - void 250
- arrays
 - converting to XDR format 85, 156, 158
 - declarations
 - RPC language 247, 248
 - XDR language 270, 271, 277
 - XDR code examples 207, 210, 211
- assign configuration-script keyword 322
- asynchronous mode 105, 106
- authdes_create routine 164
- authdes_seccreate routine 115, 164
- authentication 111, 118, 232, 242
 - access control vs. 114
 - allocating authentication numbers 232
 - AUTH_DES 112, 114, 116, 234, 239
 - AUTH_KERB 112, 116, 118, 239, 242
 - AUTH_NONE 112, 113, 233
 - AUTH_SHORT 112, 233, 234
 - AUTH_SYS (AUTH_UNIX) 112 to 114, 233, 234
- credentials
 - AUTH_DES 115, 236, 237
 - AUTH_KERB 117, 118, 240, 242
 - described 226, 227
 - window (lifetime) of 115, 117, 236, 237, 241
- current vs. previous release 164
- destroying an 112
- errors
 - AUTH_DES 236
 - AUTH_KERB 240, 241
 - AUTH_SYS 114, 234
- handles 100, 115
- low-level data structures and 100
- methods supported 112, 122
- nicknames
 - AUTH_DES 236 to 238
 - AUTH_KERB 118, 240 to 242
- NIS+ 173
- overview 111, 112, 232
- registering authentication numbers 232
- RPC protocol and 226, 227
- rpcgen tool and 69, 72
- servers 112 to 114, 116
 - service-dispatch routine and 112, 113
 - time synchronization
 - AUTH_DES authentication 115, 235, 236
 - AUTH_KERB authentication 117, 242
 - verifiers
 - AUTH_DES 235, 236
 - AUTH_KERB 117, 118, 241, 242
 - AUTH_SYS 233, 234
 - described 226, 227
- authkerb_seccreate routine 117
- authorization
 - NIS+ 173
- authsys_create routine 114, 164
- authsys_create_default routine 114, 164
- authunix_create routine 164
- authunix_create_default routine 164
- AUTH_BADCRED error 240, 241
- AUTH_BADVERF error 240
- AUTH_DES authentication 114, 116, 234, 239
 - common key 238, 239
 - conversation key 235, 237, 239
 - credentials 115, 236, 237
 - described 112, 114, 115, 234, 235
 - Diffie-Hellman encryption 115, 238, 239
 - errors 236
 - handle 115
 - Hellman encryption 235
 - nicknames 236 to 238
 - protocol in XDR language 236, 239
 - server 116
 - time synchronization 115, 236
 - verifiers 235, 236, 238
- auth_destroy 123
- auth_destroy routine 112
- AUTH_KERB authentication 116, 118, 239, 242
 - credentials 117, 118, 240, 242
 - described 112, 116, 118, 239
 - encryption 117, 118
 - errors 240, 241
 - NFS and 239, 241
 - nicknames 118, 240 to 242
 - protocol in XDR language 241, 242
 - time synchronization 117, 242
 - verifiers 117, 118, 241, 242

- AUTH_NONE authentication 112, 113, 233
- AUTH_REJECTEDCRED error 234, 240
- AUTH_REJECTEDVERF error 241
- AUTH_SHORT authentication 112
- AUTH_SHORT verifier 233, 234
- AUTH_SYS authentication 112 to 114, 233, 234
- AUTH_SYS) authentication 113
- AUTH_TIMEEXPIRE error 241
- AUTH_TOOWEAK error 240
- AUTH_UNIX (AUTH_SYS)
 - authentication 112, 114, 233, 234
- Automatic MT mode, *see* MT Auto mode\x0d

B

- batching 108, 111, 228, 297, 300
- bcast.c program 106, 107
- bcast_proc routine 107, 108
- binding
 - dynamic 302
 - TI-RPC and 31, 225
- booleans
 - RPC language 250
 - XDR language 264
- bottom level interface routines (RPC) 35, 98, 99
- broadcast RPC 106, 108
 - current vs. previous release 163
 - overview 106, 229
 - portmap routine and 303, 305
 - routines for 33, 106, 108
 - rpcbind routine and 252, 259
 - server response to 69, 70, 108
 - TS-RPC vs. TI-RPC 165, 169
- buffer size
 - specifying send and receive 93, 96
- byte arrays
 - XDR 207

C

C

- rpcgen tool and
 - ANSI C compliance 43, 56, 67
 - C-style mode 42, 56, 58, 60, 250
 - preprocessing directives 55, 56, 69, 70
 - Sun WorkShop(TM) Compilers C++ compatibility 67
 - XDR routines and 195
- C-style mode
 - rpcgen tool 42, 56, 58, 60, 250
- caching
 - NIS+ 174
 - server 99
- call semantics
 - TI-RPC 31, 225
- callback procedures
 - NIS+ 189, 190
 - RPCSEC_GSS 127
 - transient RPC program numbers and 135
 - uses for 135
- callrpc routine 163
- CBC (cipher block chaining) mode 117
- cd command 323
- changing
 - NIS+ objects in namespace 176
 - NIS+ table entry objects 176
 - port monitor configuration scripts 324, 325
 - port monitor services 316
 - version numbers of programs 132
- cipher block chaining (CBC) mode 117
- circuit-oriented transports
 - when to use 37
- circuit_n transport type 37
- circuit_v transport type 36
- classes of messages 314
- client authentication, *see* authentication\x0d
- client handles
 - creating
 - bottom level interface 35, 98
 - current vs. previous release 162
 - expert level interface 35, 93, 96
 - intermediate level interface 34, 91, 92
 - top level interface 33, 34, 48, 86, 89
 - defined 335

- destroying
 - current vs. previous release 162
 - expert level interface 96
 - top level interface 48, 88
- low-level data structures for 99, 100
- client principal 124
- client programs
 - remote copy 154, 155
 - rpcgen tool and
 - ANSI C-compliance 67
 - complex data structure passing 52, 54
 - debugging 75, 76
 - directory listing service 52, 54, 291
 - message printing code example 46, 49
 - MT-safety 42, 64, 66
 - overview 43, 46, 49
 - simplified interface 79, 80
- client stub routines
 - rpcgen tool and 41, 48, 49
 - C-style mode 58, 60
 - MT Auto mode 67
 - MT-safe 61, 62
 - MT-unsafe 62, 63
 - preprocessing directive 55
- client templates
 - rpcgen tool 42, 56 to 58, 60
- client time-out periods
 - creating timed clients 34, 88, 92
 - rpcgen tool and 69, 71
- clients
 - batched 108, 110, 297, 298
 - defined 335, 336
 - multiple versions 134, 135
 - multithreaded
 - overview 137, 141
 - safety 60, 62, 64, 66, 77, 335
 - User mode 146, 147, 149
 - NIS+ 174
 - transaction IDs and 225
 - TS-RPC vs. TI-RPC 164, 165
- _clnt.c suffix 49
- clntraw_create routine 162
- clnttcp_create routine 162
- clntudp_bufcreate routine 162
- clntudp_create routine 93, 96, 162
- clnt_broadcast routine 163, 165, 166
- clnt_call routine
 - current vs. previous release 163
 - described 34, 35
 - RPCPROGVERSMISMATCH error 134
 - top level interface and 88
- clnt_control routine
 - current vs. previous release 162
 - described 71, 96
 - using 71
- clnt_create routine
 - code example 47, 48
 - current vs. previous release 162
 - described 34
- clnt_create_timed routine
 - current vs. previous release 162
 - described 34
 - using 88
- clnt_create_vers routine 134, 162
- clnt_destroy routine
 - current vs. previous release 162
 - described 48, 88, 96
- clnt_dg_create routine
 - current vs. previous release 162
 - described 35, 98
 - using 98
- clnt_ops field 98
- clnt_pcreateerror routine
 - current vs. previous release 162
 - described 88
- clnt_perror routine 76
- clnt_raw_create routine 102, 104, 162
- clnt_spcreateerror routine 162
- clnt_sperror routine 76
- clnt_tli_create routine
 - current vs. previous release 162
 - described 35, 93, 98
 - using 93, 96
- clnt_tp_create routine 34, 162
- clnt_tp_create_timed routine
 - current vs. previous release 162
 - described 34
 - using 92
- clnt_vc_create routine
 - current vs. previous release 162
 - described 35, 98
 - using 98

- clock synchronization, *see* time synchronization\x0d
- cl_auth field 100, 112
- cl_netid field 98
- cl_private field 98
- cl_tp field 98
- comments
 - XDR language 275
- compatibility
 - library functions, current vs. previous release 161, 164
- compilation
 - NIS+ 181
 - rpcgen tool 42, 58, 60
- complex data structures
 - packing with xdr_inline 56, 68
 - rpcgen tool and 50, 54
- compound data type filters
 - XDR 85, 206
- _config file 320 to 322, 324, 332
- configuration scripts, *see* port monitors, configuration scripts\x0d
- connection-oriented endpoints 101
- connection-oriented transports
 - client handle creation for 35
 - defined 335
 - nettype parameters for 36
 - port monitors and 130, 131
 - remote copy code example 153, 156
 - server handle creation for 36
- connectionless transports
 - client handle creation for 35
 - defined 335
 - nettype parameters for 37
 - server handle creation for 35
- UDP (user datagram protocol)
- constants
 - RPC language 246
 - XDR language 273, 275, 277
- constructed data type filters
 - XDR 85, 206
- conversation key
 - AUTH_DES authentication 235, 237, 239
- converting
 - addresses 38, 39, 160
 - from XDR format 82, 85, 90, 156, 157, 201, 335

- local procedures to remote
 - procedures 43, 49
 - to XDR format 50, 54, 82, 86, 156, 158, 197, 198, 200, 201, 336
- cookies (in RPCSEC_GSS security flavor) 127
- copying
 - NIS+ database entries 178
 - NIS+ objects 179
 - NIS+ table entry objects 176
 - remote 153, 156
- counted byte strings, , *see* string declarations
- cpp directive
 - rpcgen tool and 56
- crashes
 - server 225, 236
- creating
 - NIS+ databases 178
 - NIS+ directory objects 184
 - NIS+ group objects 177, 185
 - NIS+ table objects 186, 188
 - utmpx entries 310, 317, 320
- creating, *see* client handles, creating client handles,
- creating, *see* server handles, creating\x0d server handles,
- credential
 - RPCSEC_GSS 125
- credentials
 - AUTH_DES 115, 236, 237
 - AUTH_KERB 117, 118, 240, 242
 - described 226, 227
 - window (lifetime) of 115, 117, 236, 237, 241

D

- daemons
 - kerbd 239, 240
 - rpcbind 39, 106
- data representation
 - TI-RPC 32
- data structures
 - converting to XDR format 50, 54, 82, 86, 156, 158, 198, 200, 201
 - low-level 99
 - MT safe 146

- packing with `xdr_inline` 56, 68
 - recursive 219, 222, 275
 - rpcgen tool and 50, 54
- structure declarations
- data types
 - passing arbitrary 82, 86
- database access functions (NIS+) 175, 178
- datagram transports
 - broadcast RPC and 106
 - defined 335
 - nettype parameters 36, 37
 - when to use 37
- `datagram_n` transport type 37
- `datagram_v` transport type 37
- date service
 - intermediate level client for 91, 92
 - intermediate level server for 92
 - top level client for trivial 87, 89
 - top level server for 89, 90
- `dbxtool` routine 76
- `db_add_entry` function 178
- `db_checkpoint` function 178
- `db_first_entry` function 178
- `db_list_entries` function 178
- `db_next_entry` function 178
- `db_remove_entry` function 178
- `db_reset_next_entry` function 178
- `db_standby` function 178
- deallocating memory, *see* memory, releasing\`x0d
- debugging
 - raw mode and 102, 104
 - rpcgen tool and 69, 70, 75, 76
- declarations
 - RPC language 246, 251
 - XDR language 262, 275
- defaults
 - maximum number of threads 143
 - single-threaded mode 142
- defaults, *see* rpcgen tool, defaults\`x0d
 - rpcgen tool
- define statements, command line, rpcgen tool 69, 70
- definitions
 - RPC language 244, 245, 279
- deleting
 - address registrations 162
 - associations 35

- mappings 35
 - NIS+ database entries 178
 - NIS+ directory from host 178
 - NIS+ group members 177
 - NIS+ group objects 177, 191, 195
 - NIS+ objects from namespace 176, 190, 191
 - NIS+ table entry objects 176, 191, 195
 - port monitor services 316
 - port monitors 308
- deleting, *see* unregistering\`x0d
 - address registrations
- memory, releasing
- DES encryption 115, 117, 118, 235, 238, 239
- deserializing 82, 85, 90, 156, 157, 201, 335
- destroying
 - client authentication handles 112
 - client handles 48, 88, 96, 162
 - NIS+ objects 180
 - server handles 162
 - XDR streams 214
- Diffie-Hellman encryption 115, 235, 238, 239
- `dir.x` program 50, 51, 287, 288
- directories
 - remote directory listing service 50, 54, 287, 291
 - SAF (service access facility) 332, 333
- `dir_proc.c` routine 51, 52, 287, 289
- `dir_remove` function 192
- disabling port monitors 310, 312
- discriminated unions
 - declarations
 - RPC language 249
 - XDR language 249, 272, 277
 - XDR code samples 211, 213
- dispatch tables
 - rpcgen tool 69, 73, 74
- `doconfig` function 311, 319, 321
- domains (NIS+)
 - administration commands 174
 - functions 177, 179
 - overview 171, 172
- dynamic binding 302
- dynamic program numbers 135, 136, 227

E

- ECB (electronic code book) mode 117, 118
- electronic code book (ECB) mode 117
- enabling
 - port monitors 310, 312
 - server caching 99
- encryption
 - AUTH_DES authentication
 - (Diffie-Hellman) 115, 235, 238, 239
 - AUTH_KERB authentication 117, 118
 - privacy service 119
- endnetconfig routine 95
- endpoints
 - connection-oriented 101
- enumeration filters
 - XDR primitives 205, 206
- enumerations
 - RPC language 51, 245, 246
 - XDR language 264
- errors
 - authentication
 - AUTH_DES 236
 - AUTH_KERB 240, 241
 - AUTH_SYS 114, 234
 - client handle creation 88
 - multiple client version 134
 - NIS+ error message display
 - functions 175, 179
 - RPC 48, 76, 226
 - thr_create 143
 - /etc/gss/mech 129
 - /etc/inet/inetd.conf file 131
 - /etc/netconfig database 36, 69, 161
 - /etc/rpc database 32
 - /etc/saf/_pid file 310, 320, 326, 333
 - /etc/saf/ directory 332
 - /etc/saf/_config file 320 to 322, 324, 332
 - /etc/saf/_pmpipe file 312, 320, 333
 - /etc/saf/_pmtab file 311, 316, 317, 320, 333
 - /etc/saf/_svctag file 316, 317, 320, 321, 333
 - /etc/saf/_sactab files 315
 - /etc/saf/_sactab files 332
 - /etc/saf/_sysconfig file 321, 324, 332
- expert level interface routines (RPC) 34, 93, 97
 - client 93, 96

- overview 34, 93
- server 96, 97

external data representation, *see* XDR (external data representation)\x0d

F

- file data structure
 - XDR language 278
- file descriptors, passing open TLI 93, 96
- file system, *see* NFS (network file system)\x0d
- filters (XDR)
 - arrays 207, 210, 211
 - constructed (compound) data type 85, 206
 - enumeration 205, 206
 - floating point 82, 205
 - number 82, 84, 204, 205
 - opaque data 210, 211
 - strings 85, 206, 207
 - unions 211, 213
- fixed-length arrays
 - declarations
 - RPC language 247
 - XDR language 270
 - XDR code sample 211
- fixed-length opaque data
 - XDR language 268
- flags, *see* rpcgen tool, flags\x0d
- flavor
 - meaning, with RPCSEC_GSS 120
- floating point
 - XDR language 266, 267
- floating point filters
 - XDR primitives 82, 205
- free routine 54
- freeing resources
- freenetconfig routine 91

G

- getnetconfig routine 95
- getnetconfig routine 91
- glossary 335, 337
- groups (NIS+)
 - administration commands 173, 174

- manipulation functions 175, 177
- sample programs 185, 191, 195

gsscred command 129
gsscred file 129

H

hand-coded registration routine 81
handles

- authentication 100, 115
- defined 335

transport handles
header files

- rpcgen tool and 49, 55

hosts

- defined 335

hyper integers

- XDR language 265

I

.i suffix 73
I/O streams

- XDR 215

idempotent

- defined 31

identifiers

- XDR language 275

identifying

- port monitor services 316
- remote procedures 32, 225, 226, 228

naming
index table

- rpcgen tool and 55

indirect RPC 255, 256, 259
inetd port monitor

- RPC services 131, 135
- rpcgen tool and 49, 71
- using 130, 131

inetd.conf file 131
information reporting

- addresses 40
- NIS+ 177
- remote host status 137, 141
- RPC 40
- rpcbind server 259
- server callbacks 135

installing port monitor configuration

- scripts 324, 325

int vs. long 75
integers

- XDR language 197, 198

integers, XDR language 263, 265
integrity 119
interfaces, *see* RPC (remote procedure call),
interface routines
intermediate level interface routines
(RPC) 34, 90
Internet protocols, *see* TCP (transport control
protocol)
ISTATE environment variable 310, 312, 319
IXDR_GET_LONG 75
IXDR_PUT_LONG 75

K

kerbd daemon 239, 240
Kerberos authentication, *see* AUTH_KERB
authentication\x0d
keywords

- RPC language 51
- XDR language 277

KGETKCRED procedure 239, 240
KGETUCRED procedure 239, 240
KSETKCRED procedure 239, 240

L

lib library 54
libc library 160, 161
libnsl library 49, 51, 160, 161
libraries

- lib 54
- libc 160, 161
- libnsl 49, 51, 160, 161
- librpcsvc 78
- lthread 137
- RPC functions 161, 164
- rpcgen tool and
 - libnsl 49, 51, 160, 161
 - selecting TI-RPC or TS-RPC
library 43, 56, 67
- XDR 200, 201

librpcsvc library 78

- lifetime of credentials, *see* window of credentials\x0d
- limits
 - broadcast request size 106
 - maximum number of threads 143
- linked lists
 - XDR 219, 222, 275
- listen port monitor
 - administrative command for 311
 - rpcgen tool and 49, 71
 - using 130 to 132
- listing
 - NIS+ objects 180, 189, 190
 - NIS+ principals 177
 - NIS+ servers 178
 - NIS+ table objects 176, 188, 190
 - portmap mappings 305
 - remote directory listing service 50, 54, 287, 291
 - rpcbind addresses 259
 - rpcbind mappings 32, 255, 257
- live code examples 287, 300
 - adding two numbers program 292
 - batched code 297, 300
 - directory listing program 287, 291
 - print message program 294, 297
 - spray packets program 292, 293
 - time server program 291
- loading, *see* binding\x0d
- local procedures
 - converting to remote procedures 43, 49
- locks
 - mutex, multithreaded mode and 142
 - port monitor IDs and lock files 310, 320, 333
- log functions
 - NIS+ transaction 175, 179
- _log file
 - SAC (service access controller) 333
- long vs. int 75
- low-level data structures 99
- lthread library 137

M

- main server function 71
- makefile templates
 - rpcgen tool 42, 57

- mapping 35
- rpcbind routine
- master servers
 - NIS+ 172, 174, 193, 194
- maximums
 - broadcast request size 106
 - number of threads 143
- mechanism, security 120
- memory
 - allocating with XDR 156, 158
 - releasing
 - clnt_destroy routine 48, 88, 96
 - free routine 54
 - messageprog_1_freeresult routine 63
 - NIS+ 176 to 178
 - simplified interface and 86
 - svc_done routine 147
 - svc_freeargs routine 157
 - XDR_FREE operation 206
 - xdr_free routine 54, 63
 - XDR primitive requirements for 202, 204, 206
- memory streams
 - XDR 216
- memory, releasing
- mesg_proc.c routine 296, 297
- message classes 314
- message interface (SAF) 312, 314, 320, 325, 331, 333
- messageprog_1_freeresult routine 63
- modifying, *see* changing\x0d
- msg.h header file 49
- msg.x program 61
- msg_clnt.c routine 49
- msg_svc.c program 49
- msg_svc.c routine 49
- MT Auto mode 141, 143, 146
 - code examples 144, 146
 - described 141, 143
 - rpcgen tool and 42, 56, 66
 - service transport handle and 143
- MT hot
 - defined 335
- MT RPC programming, *see* multithreaded RPC programming\x0d
- MT User mode 141, 143, 146, 153
- MT-safe code

- clients 42, 60, 62, 64, 66, 77, 335
- defined 335
- rpcgen tool and 42, 56, 60, 66
- servers 42, 62, 64, 66, 77, 142, 335
- multiple client versions 134, 135
- multiple server versions 132, 133
- multithreaded Auto mode, *see* MT Auto mode\x0d
- multithreaded hot
 - defined 335
- multithreaded RPC programming 136, 153
 - clients
 - overview 137, 141
 - safety 42, 60, 62, 64, 66, 77, 335
 - User mode 146, 147, 149
 - library 137
 - maximum number of threads 143
 - overview 136
 - performance enhancement 144, 149
 - rpcgen tool and 42, 56, 60, 67
 - servers
 - Auto mode 42, 56, 66, 141, 143, 146
 - overview 136, 141, 143
 - safety 42, 62, 64, 66, 77, 142, 335
 - timing diagram 142
 - unsafe routines 141
 - User mode 141, 143, 146, 149, 153
- multithreaded User mode 141, 143, 146, 153
- multithreaded-safe code, *see* MT-safe code\x0d
- mutex locks
 - multithreaded mode and 142

N

- Name Service Switch 173
- name-to-address translation 38, 39, 160
- naming
 - client stub programs by rpcgen 49
 - netnames 115, 235
 - programs by version number 132
 - remote procedure calls by rpcgen 46
 - server programs by rpcgen 49
 - standard for 235
 - template files for rpcgen 58
- naming service, *see* NIS+ (Network Information Services Plus)\x0d

- NIS+ (Network Information Services Plus)
 - netbuf addresses 258
 - netconfig database 36, 69, 161
 - netnames 115, 235
 - NETPATH environment variable 36, 69, 88
 - nettype parameters 36, 37
 - network addresses, *see* addresses\x0d
 - network file system, *see* NFS (network file system)\x0d
 - Network Information Services Plus, *see* NIS+ (Network Information Services Plus)\x0d
 - network names 115, 235
 - network pipes 197
 - network selection
 - RPC 36
 - rpcgen tool 69
 - network services
 - defined 336
 - Newstyle (C-style) mode
 - rpcgen tool 42, 56, 58, 60
 - NFS (network file system)
 - described 24
 - Kerberos authentication and 239, 241
 - NFSPROC_GETATTR procedure 240
 - NFSPROC_STATVFS procedure 241
 - nicknames
 - AUTH_DES 236 to 238
 - AUTH_KERB 118, 240 to 242
 - NIS+
 - servers
 - sample program 193, 194
- NIS+ (Network Information Services Plus) 171, 195
 - application programming interface (API) 175, 180
 - cache administration commands 174
 - client administration commands 174
 - compilation 181
 - database access functions 175, 178
 - domains
 - administration commands 174
 - functions 177, 179
 - overview 171, 172
 - error message display functions 175, 179

- groups
 - administration commands 173, 174
 - manipulation functions 175, 177
 - sample programs 185, 191, 195
- local name functions 175, 177, 179, 180
- miscellaneous functions 175, 179, 180
- Name Service Switch 173
- namespace administration
 - commands 173 to 175
- objects
 - administration commands 173, 174
 - manipulation functions 175, 179
 - sample programs 181, 195
- overview 25, 171, 175
- sample program 180, 195
- security 173
 - administration commands 173
- servers
 - administration commands 174
 - functions 175, 178
 - overview 172
- tables
 - access functions 175, 176
 - administration commands 174
 - overview 172, 173
 - sample programs 186, 188
- time synchronization 179
- transaction log functions 175, 179
- unsupported macros 180
- nisaddcred command 174
- nisaddent command 174
- niscat command 174
- nischgrp command 173
- nischmod command 173
- nischown command 173
- nischttl command 174
- nisdefaults command 174
- nisgrep command 174
- nisgrpadm command 174
- nisinit command 174
- nisln command 175
- nisls command 174
- nismatch command 173, 174
- nismkdir command 174
- nisspasswd command 174
- nisrm command 175
- nisrmdir command 174
- nissetup command 174
- nisshowcache command 175
- nistbladm command 174
- nisupdkeys command 174
- nis_add function 176, 181, 185, 187
- nis_addmember function 177, 181, 184
- nis_add_entry function 176, 181, 188
- nis_admin functions 179
- nis_cachemgr command 174
- nis_checkpoint function 179
- nis_clone_object function 179
- nis_creategroup function 177, 181, 185
- nis_db functions 178
- nis_destroygroup function 177, 181, 191
- nis_destroy_object function 180
- nis_dir_cmp function 179
- nis_domain_of function 179, 181
- nis_error functions 179
- nis_first_entry function 176
- nis_freenames function 177
- nis_freeresult function 176, 181
- nis_freeservlist function 178
- nis_freetags function 178
- nis_getnames function 177
- nis_getservlist function 178
- nis_groups functions 177
- nis_ismember function 177
- nis_leaf_of function 179, 181, 189
- nis_lerror function 179
- nis_list function 176, 181, 188, 190
- nis_local_directory function 177, 181, 182
- nis_local_group function 177
- nis_local_host function 177
- nis_local_names functions 177
- nis_local_principal function 177, 181, 182
- nis_lookup function 176, 181, 183, 187, 189
- nis_mkdir function 178, 181, 185
- nis_modify function 176
- nis_modify_entry function 176
- nis_name_of function 179
- nis_next_entry function 177
- nis_perror function 179, 181
- nis_ping function 179
- nis_print_group_entry function 177
- nis_print_object function 180
- nis_remove function 176, 181, 185, 190 to 192
- nis_removemember function 177, 181, 191
- nis_remove_entry function 176, 181, 191, 192

- nis_rmdir function 178
- nis_server functions 178
- nis_servstate function 178
- nis_sperrno function 179
- nis_sperror function 179
- nis_stats function 178
- nis_subr functions 179, 180
- nis_tables functions 176
- nis_verifygroup function 177
- nlsadmin command 311
- no-data routine
 - XDR 206
- NULL arguments 81
- NULL pointers 214
- NULL strings 251
- NULL transport type 36
- number filters, XDR 82, 84, 204, 205
- number of users
 - on a network 113, 114
 - on a remote host 78
- numbers
 - adding two 292
- version numbers

O

- objects (NIS+)
 - administration commands 173, 174
 - manipulation functions 175, 179
 - sample programs 181, 195
- ONC+ overview 24, 25
- opaque data
 - declarations
 - RPC language 251
 - XDR language 268, 269
 - XDR code examples 210, 211
- open TLI file descriptors
 - passing 93, 96
- optional-data unions
 - XDR language 274

P

- parameters, *see* arguments\x0d
- passing parameters, *see* arguments\x0d
- percent sign (%), preprocessing directive 55
- _pid file 310, 320, 326, 333
- ping program 243, 244, 336

- pipes
 - network 197
 - _pmpipe file 312, 320, 333
 - _sacpipe file 312, 320, 333
- pmadm command 131, 132, 311, 316, 318, 324, 325
- PMAPPROC_CALLIT procedure 305
- PMAPPROC_DUMP procedure 305
- PMAPPROC_GETPORT procedure 305
- PMAPPROC_NULL procedure 304
- PMAPPROC_SET procedure 304
- PMAPPROC_UNSET procedure 305
- pmap_getmaps routine 163
- pmap_getport routine 163, 164
- pmap_rmtcall routine 163
- pmap_set routine 163
- pmap_unset routine 163
- pmmsg structure 313
 - _pmpipe file 312, 320, 333
 - _pmtab file 311, 316, 317, 320, 333
 - / directory 312, 316, 332, 333
- PMTAG environment variable 312, 319
- pm_maxclass field 314
- pm_size field 313, 314
- pointers
 - remote procedures 46
 - RPC language 248
 - XDR code examples 213, 214
- poll routine 105, 106
- pop configuration-script keyword 323
- port monitors
 - activity monitoring 309
 - adding 308
 - adding services 316
 - administrative commands
 - monitor-specific command 318
 - pmadm 131, 132, 311, 316, 318, 324, 325
 - sacadm 132, 308, 315, 317, 324
- administrative files
 - _pmtab 311, 316, 317, 320, 333
 - _sactab 332
 - _sactab 315
- administrative interface 314, 320
- changing port monitor services 316

- configuration scripts 321, 325
 - installing 324, 325
 - language for writing 322, 323
 - per-port monitor 320 to 322, 324, 332
 - per-service 311, 312, 319 to 322, 324, 325, 333
 - per-system 321, 324, 332
 - printing 324, 325
 - replacing 324, 325
- deleting services 316
- disabling 310, 312
- enabling 310, 312
- files
 - administrative 311, 315 to 317, 319, 332, 333
 - key 319
 - per-port monitor configuration 320 to 322, 324, 332
 - per-service configuration 311, 312, 319 to 321, 324, 325, 333
 - per-system configuration 321, 324, 332
 - private 312, 316
 - process ID 310, 320, 333
- functions 309, 311, 320
- home directory for 332
- identifying services 316
- management function 309
- message interface 312, 314, 320, 325, 331, 333
- _pmpipe file 312, 320, 333
- private files 312, 316
- process IDs and lock files 310, 320, 333
- removing 308
- requirements for implementing 319
- restricting access to system 310
- rpcgen tool and 49, 69, 71
- sample code 325, 331
- service interface 318
- terminating 311, 320
- types of 315
- using 130, 132
- utmpx entry creation 310, 317, 320
- version numbers 317, 318
- port monitors, *see* SAF (service access facility)\x0d
 - writing with service access facility
- port numbers
 - getting for registered services 164, 301, 305
 - portmap routine 304
 - rpcbind routine 39, 256
 - TCP/IP protocol 39, 256, 304
 - UDP/IP protocol 39, 256, 304
- porting data, , *see* XDR (external data representation)\x0d
- porting TS-RPC to TI-RPC 158, 169
 - applications 158
 - benefits 158
 - code comparison examples 164, 169
 - differences between TI-RPC and TS-RPC 160, 164, 169
 - function compatibility lists 161, 164
 - libc library and 160
 - libnsl library and 160
 - name-to-address mapping and 160
 - old interfaces and 160
- portmap routine 301, 305
 - address management functions 163
 - broadcast RPC and 303, 305
 - operation of 304, 305
 - overview 301, 302
 - port number 304
 - protocol specification for 302, 304
 - replacement of 38, 301
 - TS-RPC and 161
- ports
 - defined 309
- preprocessing directives
 - rpcgen tool 55, 56, 69, 70
- principal
 - client 124
 - server 124
- printing
 - message to system console 43, 49, 294, 297
 - port monitor configuration scripts 324, 325
- printmsg.c program
 - remote version 44, 49, 294, 297
 - single process version 43, 44, 294
- privacy 119
- procedure numbers
 - described 32, 226
 - error conditions 226

- procedure-lists
 - RPC language 245
 - procedures
 - registering as RPC programs 33, 81
 - RPC language 245
 - program declarations
 - RPC language 249, 250
 - program numbers 226, 228
 - assigning 227, 228
 - described 32, 226
 - error conditions 226
 - registering 228
 - transient (dynamically assigned) 135, 136, 227
 - program numbers, *see* portmap routine mapping
 - program-definitions
 - RPC language 245
 - PROGVERS program name 132
 - PROGVERS_ORIG program name 132
 - protocols
 - AUTH_DES 236, 239
 - rpcbind protocol specification 251, 256
 - specifying in RPC language 45
 - XDR language
 - push configuration-script keyword 322
- Q**
- QOP (Quality of Protection) 120
 - quadruple-precision floating point
 - XDR language 267
 - Quality of Protection, *see* QOP
- R**
- raw RPC
 - testing programs using low-level 102, 104
 - READDIR procedure 50, 54, 287, 291
 - record streams
 - XDR 216, 217, 232
 - record-marking standard 232
 - recursive data structures 219, 222, 275
 - registering
 - authentication numbers 232
 - current vs. previous release 162
 - hand-coded registration routine 81
 - procedures as RPC programs 33, 80, 81
 - program numbers 228
 - program version numbers 132
 - registering, *see* portmap routine addresses
 - registerrpc routine 163
 - releasing memory, *see* memory, releasing\x0d
 - remote copy routine 153, 156
 - remote directory listing service 50, 54
 - remote procedure call, *see* RPC (remote procedure call)\x0d
 - remote procedures
 - converting local procedures to 43, 49
 - identifying 32, 225, 226, 228
 - remote time protocol 55, 67
 - removing, *see* deleting
 - rendezvousing
 - TI-RPC and 225
 - replacing, *see* changing\x0d
 - replica servers
 - NIS+ 172, 174
 - reporting, *see* information reporting\x0d
 - rls.c routine 54, 291
 - RPC (remote procedure call)
 - address lookup services 35, 38, 39
 - address reporting 40
 - address translation 38, 39, 160
 - asynchronous mode 105, 106
 - batching 108, 111, 228, 297, 300
 - described 29, 30, 224
 - errors 48, 76, 226
 - failure of 48
 - identifying remote procedures 32, 225, 226, 228
 - indirect 255, 256, 259
 - information reporting 40, 135
 - interface routines 32, 36, 77, 99
 - bottom level 35, 98, 99
 - caching servers 99
 - expert level 34, 93, 97
 - intermediate level 34, 90
 - low-level data structures 99
 - overview 32, 36, 77, 78, 86
 - simplified 33, 78, 86
 - standard 33, 36, 86
 - top level 33, 48, 86, 90

- multiple client versions 134, 135
- multiple server versions 132, 133
- name-to-address translation 38, 39, 160
- network selection 36
- poll routine 105, 106
- port monitor usage 130, 132
- raw, testing programs using
 - low-level 102
- record-marking standard 232
- standards 30, 232
- transient RPC program numbers 135, 136, 227
- transport selection 37
- transport types 36, 37
- RPC (remote procedure call), *see* broadcast
 - RPC\x0d
 - broadcast
- RPC (remote procedure call), *see* portmap
 - RPC (remote procedure call), *see* portmap routine
 - address registration
- RPC (remote procedure call), *see* TI-RPC
 - (transport-independent remote procedure call) protocol\x0d
- protocol
- RPC (remote procedure call), *see* TI-RPC
 - (transport-independent remote procedure call), interface routines\x0d
 - interface routines
- rpcgen tool
- RPC language
 - reference 279, 286
- RPC language (RPCL) 243, 251
 - arrays 247, 248
 - booleans 250
 - C vs. 41
 - C-style mode and 250
 - constants 246
 - declarations 246, 248
 - definitions 244, 245, 279
 - discriminated unions 51, 249
 - enumerations 51, 245, 246
 - example protocol described in 45
 - example service described in 243, 244
 - fixed-length arrays 247
 - keywords 51
 - opaque data 251
 - overview 279, 336
 - pointers 248
 - portmap protocol specification in 303, 304
 - program declarations 249, 250
 - simple declarations 246
 - special cases 250, 251
 - specification for 243, 251
 - strings 45, 251
 - structures 51, 248
 - syntax 244, 245, 279
 - type definitions 246
 - unions 51, 249
 - variable-length arrays 247
 - voids 251
 - XDR language vs. 243, 244, 279
- rpc.nisd command 174
- RPC/XDR, *see* RPC language (RPCL)\x0d
- rpcbind daemons
 - broadcast RPC and 106
 - registering addresses with 39
- rpcbind routine
 - address management functions 163
 - broadcast RPC and 252, 259
 - calling 35
 - described 31, 38, 39, 161, 164, 235, 251
 - listing mappings 32, 255, 257
 - operation of 256, 259
 - port number 39, 256
 - portmap routine replaced by 38, 301
 - protocol specification for 251, 256
 - time service 164, 235, 258
 - version 4 258, 259
- RPCBPROC_BCAST procedure 255, 259
- RPCBPROC_CALLIT procedure 39, 255, 258, 259
- RPCBPROC_DUMP procedure 255, 257
- RPCBPROC_GETADDR procedure 254, 257
- RPCBPROC_GETADDRLIST procedure 256, 259
- RPCBPROC_GETSTAT procedure 256, 259
- RPCBPROC_GETTIME procedure 235, 255, 258
- RPCBPROC_GETVERSADDR procedure 256, 259
- RPCBPROC_INDIRECT procedure 255, 256, 259

- RPCBPROC_NULL procedure 254, 257
- RPCBPROC_SET procedure 254, 257, 259
- RPCBPROC_TADDR2UADDR
 - procedure 255, 256, 258
- RPCBPROC_UADDR2TADDR
 - procedure 255, 256, 258
- RPCBPROC_UNSET procedure 254, 257, 259
- rpcb_getaddr routine 35, 164
- rpcb_getmaps routine 164
- rpcb_gettime routine 164
- rpcb_rmtcall routine 164
- rpcb_set routine
 - current vs. previous release 164
 - described 35, 96
- rpcb_unset routine 35, 164
- rpcgen tool 41, 76
 - 64- vs. 32-bit systems 74
 - add two numbers program 292
 - advantages 42
 - arguments 46, 58, 60, 81, 82, 86, 250
 - authentication and 69, 72, 114, 118
 - batched code example 297, 300
 - broadcast call server response 69, 70
 - C and
 - ANSI C compliance 43, 56, 67
 - C-style mode 42, 56, 58, 60, 250
 - preprocessing directives 55, 56, 69, 70
 - Sun WorkShop(TM) Compilers C++ compatibility 67
 - compilation modes 42, 58, 60
 - complex data structure passing 50, 54
 - converting local procedures to remote procedures 43, 49
 - cpp directive 56
 - debugging 69, 70, 75, 76
 - defaults
 - argument passing mode 58 to 60
 - C preprocessor 56
 - client time-out period 71
 - compilation mode 42
 - library selection 67
 - MT-safety 42, 60
 - output 41
 - server exit interval 71
 - define statements on command line 69, 70
 - described 41, 42
 - directory listing program 50, 54, 287, 291
 - dispatch tables 69, 73, 74
 - failure of remote procedure calls 48
 - flags
 - listed 56
 - Sc (templates) 57
 - i (xdr_inline count) 56
 - A (MT Auto mode) 56, 66
 - a (templates) 56, 57
 - b (TS-RPC library) 56, 67
 - i (xdr_inline count) 68
 - M (MT-safe code) 56, 60
 - N (C-style mode) 56, 58
 - Sc (templates) 56
 - Sm (templates) 56, 57
 - Ss (templates) 56, 57
 - hand-coding vs. 81
 - libraries
 - libnsl 49, 51, 160, 161
 - selecting TI-RPC or TS-RPC library 43, 56, 67
 - MT (multithread) Auto mode 42, 56, 66, 143, 146
 - MT (multithread)-safe code 42, 56, 60, 66
 - naming remote procedure calls 46
 - network types/transport selection 69
 - Newstyle (C-style) mode 42, 56, 58, 60
 - optional output 41
 - pointers 46
 - port monitor support 49, 69, 71
 - preprocessing directives 55, 56, 69, 70
 - print message program 43, 49, 294, 297
 - programming techniques 69, 76
 - socket functions and 67
 - spray packets program 292, 293
 - SunOS 5.x features 42, 43
 - templates 42, 56 to 58, 60
 - TI-RPC vs. TS-RPC 160
 - TI-RPC vs. TS-RPC library selection 43, 56, 67
 - time server program 55, 67, 291
 - time-out changes 69, 71
 - tutorial 43, 56
 - variable declarations and 247
 - XDR routine generation 50, 54, 55, 195
 - xdr_inline count 56, 68
- rpcgen tool, *see* client handles

- handles and
- rpcgen tool, *see* client handles\x0d
 - client handles and
- rpcgen tool, *see* client programs\x0d
 - client programs and
- rpcgen tool, *see* client stub routines
 - stub routines and
- rpcgen tool, *see* client stub routines\x0d
 - client stub routines and
- rpcgen tool, *see* server handles\x0d
 - server handles and
- rpcgen tool, *see* server programs\x0d
 - server programs and
- rpcgen tool, *see* server stub routines
 - server stub routines and
- rpcinfo routine 39, 40
- rpcproc_t, *see* 64-bit system
- RPCPROGVERSMISMATCH error 134
- rpcprog_t, *see* 64-bit system
- RPCSEC_GSS security flavor
 - associated files 129
 - auth_destroy 123
 - callbacks 127
 - changing values 123
 - cookies 127
 - creating a context 122
 - credentials 125
 - destroying a context 123
 - /etc/gss/mech file 129
 - get list of mechanisms 128
 - get list of QOPs 128
 - getting maximum data size 128
 - gsscred table 129
 - gsscred utility 129
 - list of routines 120
 - meaning of “flavor” 120
 - mechanism 120
 - principal names 124
 - QOP 120
 - receiving credentials 125
 - rpc_gss_getcred 125
 - rpc_gss_get_mechanisms 128
 - rpc_gss_get_mech_info 128
 - rpc_gss_get_principal_name 124
 - rpc_gss_max_data_length 128
 - rpc_gss_seccreate 122
 - rpc_gss_set_callback 127
 - rpc_gss_set_defaults 123
- rpc_gss_set_svc_name 124
- rpc_gss_svc_max_data_length 128
- RPC_AUTHERROR error 236
- rpc_broadcast routine
 - current vs. previous release 163, 165
 - described 33
 - source code 166, 169
 - using 106, 108
- rpc_call routine
 - current vs. previous release 163
 - described 33, 79
 - using 79, 80
- RPC_CLNT preprocessing directive 55
- rpc_control routine 141, 143, 147
- rpc_createerr global variable 88
- __rpc_dtbsize function 105
- rpc_gss_getcred 125
- rpc_gss_get_mechanisms 128
- rpc_gss_get_principal_name 124
- rpc_gss_is_installed 128
- rpc_gss_max_data_length 128
- rpc_gss_principal_t principal name
 - structure 124
- rpc_gss_principal_t principal structure
 - name 125
- rpc_gss_seccreate 122
- rpc_gss_service_t enum 123
- rpc_gss_set_callback 127
- rpc_gss_set_defaults 123
- rpc_gss_set_svc_name 124
- rpc_gss_svc_max_data_length 128
- RPC_HDR preprocessing directive 55
- rpc_reg routine
 - current vs. previous release 163
 - described 33
 - using 80, 82
- __rpc_select_to_poll function 105
- RPC_SVC preprocessing directive 55
- RPC_SVC_MTMODE_GET library
 - routine 143, 147
- RPC_SVC_MTMODE_SET library
 - routine 143

- RPC_SVC_THRCREATES_GET library
 - routine 143
- RPC_SVC_THRERRORS_GET library
 - routine 143
- RPC_SVC_THRMAX_GET library
 - routine 143
- RPC_SVC_THRMAX_SET library routine 143
- RPC_SVC_THRTOTAL_GET library
 - routine 143
- RPC_TBL preprocessing directive 55
- RPC_XDR preprocessing directive 55
- rprintmsg routine 49
- rq_clntcred field 112
- rq_cred field 112, 113
- rstat program
 - multithreaded 137, 141
- run configuration-script keyword 323
- runwait configuration-script keyword 323
- rusers routine 81
- rusersDefault Para Font routine 78

S

- SAC (service access controller)
 - described 308, 311
 - key files 315, 319, 332
 - log file 333
 - message interface 312, 314, 320, 325, 331, 333
 - _sacpipe file 312, 320, 333
 - _sactab file 315, 332
 - sac.h header file 329, 331
 - sacadm command 132, 308, 315, 317, 324
 - starting 320, 321
- sac.h header file 329, 331
- sacadm command 132, 308, 315, 317, 324
- _sacpipe file 312, 320, 333
- _sactab file 315, 332
- SAF (service access facility) 307, 333

- administrative interface 314, 320, 324, 325
 - key files 319
 - monitor-specific command 318
 - pmadm command 131, 132, 311, 316, 318, 324, 325
 - port monitor implementation
 - requirements 319
 - port monitor responsibilities 320
 - sacadm command 132, 308, 315, 317, 318, 324
 - _pmtab file 311, 316, 317, 320, 333
 - _sactab file 315, 332
 - service interface 318
- configuration scripts 321, 325
 - installing 324, 325
 - language for writing 322, 323
 - per-port monitor 320 to 322, 324, 332
 - per-service 311, 312, 319 to 322, 324, 325, 333
 - per-system 321, 324, 332
 - printing 324, 325
 - replacing 324, 325
- directory structure 332, 333
- files used by 311, 315 to 317, 319
- logic diagram 331
- message interface 312, 314, 320, 325, 331, 333
- overview 307, 311
- port monitor functions and 309, 311, 320, 321
- SAC (service access controller) and 308, 311, 312, 314
- sample code 325, 331
- terminating port monitors 311, 320
- sc_size field 313, 314
- searching NIS+ tables 176
- security
 - mechanism 120
 - NIS+ 173
 - QOP 120
 - service 119
- security flavor
 - meaning, with RPCSEC_GSS 120
- security mechanism 120
- authentication
- semantics
 - TI-RPC call 31, 225

- serializing 50, 54, 82, 86, 156, 158, 197, 198, 200, 201, 336
- server handles
 - creating
 - bottom level interface 35, 98, 99
 - current vs. previous release 162
 - expert level interface 35, 96, 97
 - intermediate level interface 34, 92
 - top level interface 33, 34, 89, 90
 - destroying, current vs. previous release 162
 - low-level data structures for 100
- server principal 124
- server programs
 - remote copy 155, 156
 - rpcgen tool and
 - broadcast call response 69, 70
 - C-style mode 60
 - client authentication 69, 72, 112, 113
 - complex data structure passing 51, 52
 - debugging 75, 76
 - directory listing service 51, 52, 287, 289
 - MT Auto mode 66
 - MT-safety 42, 66
 - network type/transport selection 69
 - overview 43, 49
 - simplified interface 80
 - transient RPC program 135
- server stub routines
 - rpcgen tool and 41, 43, 49
 - ANSI C-compliant 67
 - MT Auto mode 67
 - MT-safe 42, 62, 64
 - preprocessing directive 55
- server templates
 - rpcgen tool 42, 56, 57, 60
- server transport handle 100
- servers
 - authentication and 112 to 114, 116
 - batched 110, 111, 297, 299
 - caching 99
 - crashes 225, 236
 - defined 336
 - dispatch tables 69, 73, 74
 - exit interval, rpcgen tool and 71
 - multiple versions 132, 133
 - multithreaded
 - Auto mode 42, 56, 66, 141, 143, 146
 - overview 136, 141, 143
 - safety 42, 62, 64, 66, 77, 142, 335
 - unsafe routines 141
 - User mode 141, 143, 146, 149, 153
 - NIS+ 172, 174, 178
 - poll routine and 105, 106
 - port monitors and 130, 132
 - transaction IDs and 225
- service 119
- service access controller, *see* SAC (service access controller)\x0d
 - access controller)\x0d
- service access facility, *see* SAF (service access facility)\x0d
- service transport handle (SVCXPRT) 130, 143
- service-dispatch routine
 - authentication and 112, 113
- setnetconfig routine 95
- signed integers
 - XDR language 263
- simple declarations
 - RPC language 246
- simplified interface routines (RPC) 33, 78, 86
 - client 79, 80
 - hand-coded registration routine 81
 - MT safety of 77
 - overview 33, 78
 - server 80
 - XDR conversion 82, 86
- single-threaded mode
 - as default 142
 - poll routine and 105, 106
- sixty-four-bit system, *see* 64-bit system
- socket functions, *see* TS-RPC (transport-specific remote procedure call)\x0d
- spray.x (spray packets) program 292, 293
- standard interface routines (RPC) 33, 36, 86
 - bottom level routines 35, 98, 99
 - expert level routines 34, 93, 97
 - intermediate level routines 34, 90
 - low-level data structures 99
 - MT safety of 77
 - server caching 99
 - top level routines 33, 48, 86, 90
- standards

- ANSI C standard, rpcgen tool and 43, 56, 67
- naming standard 235
- record-marking standard 232
- RPC 30, 232
- XDR canonical standard 199
- statistics, *see* information reporting\x0d
- status reporting, *see* information reporting\x0d
- stream transports
 - defined 336
- STREAMS modules
 - port monitor configuration and 323, 324
- streams, *see* XDR (external data representation), streams\x0d
- string declarations
 - RPC language 45, 251
 - XDR language 269, 270
- string representation
 - XDR routines 85, 206, 207
- structure declarations
 - RPC language 51, 248
 - XDR language 271, 277, 278
- stub routines, *see* client stub routines
- Sun RPC, *see* TI-RPC (transport-independent remote procedure call)\x0d
- Sun WorkShop(TM) Compilers C++
 - rpcgen tool and 67
- SunOS 5.x
 - rpcgen tool features 42, 43
- _svc suffix 67
- _svc.c suffix 49
- svcerr_systemerr routine 114
- svcf_create routine 162
- svctag file 316, 317, 320, 321, 333
- svcudp_create routine 96, 97, 162
- SVCXPRT service transport handle 130, 143
- svc_create routine
 - current vs. previous release 162
 - described 34, 90
- svc_destroy routine 162
- svc_dg_create routine
 - current vs. previous release 162
 - described 35, 101
 - using 99
- svc_dg_enablecache routine 99
- svc_done routine 141, 147
- svc_fd_create routine 130, 131, 162
- svc_freeargs routine 157
- svc_getargs routine
 - described 157
 - MT performance and 144, 149
- svc_getcaller routine 163
- svc_getreqpoll routine 105, 141
- svc_getreqset routine 105, 141
- svc_getrpccaller routine 163
- svc_pollset routine 105
- svc_raw_create routine 102, 104, 162
- svc_reg routine
 - current vs. previous release 163
 - described 35
 - port monitors and 130
- svc_register routine 163
- svc_run routine
 - bypassing 105
 - described 80, 90
 - multithreaded RPC servers and 141
 - poll routine and 105, 106
- svc_sendreply routine 90
- svc_tli_create routine
 - current vs. previous release 162
 - described 35, 96
 - using 96, 97, 130
- svc_tp_create routine 34, 162
- svc_udp_bufcreate routine 162
- svc_unreg routine 35, 163
- svc_unregister routine 163
- svc_vc_create routine
 - current vs. previous release 162
 - described 36, 101
 - using 99
- svrerr_weakauth routine 114
- synchronization, *see* time synchronization\x0d
- syntax
 - RPC language 244, 245, 279
 - XDR language 277
- _sysconfig file 321, 324, 332

T

- tables (NIS+)
 - access functions 175, 176
 - administration commands 174

- overview 172, 173
- sample programs 186, 188
- /tag directory, *see* /pmtag directory\x0d
- TCP (transport control protocol)
 - nettype parameter for 37
 - porting TCP applications from TS-RPC to TI-RPC 158
 - portmap port number for 304
 - portmap sequence for 302
 - RPC protocol and 224
 - rpcbind port number for 39, 256
 - server crashes and 225
- tcp transport type 37
- TCP/IP protocol, *see* TCP (transport control protocol)\x0d
- TCP/IP streams
 - XDR 216, 217, 232
- templates
 - rpcgen tool 42, 56 to 58, 60
- terminating port monitors 311, 320
- testing
 - NIS+ groups 177
 - programs using low-level raw RPC 102, 104
- thread library
 - thread 137
- thread.h file 146
- threads, *see* MT Auto mode
- thr_create routine 146
- TI-RPC (transport-independent remote procedure call)
 - address lookup services 35, 38, 39
 - address reporting 40
 - address translation 38, 39, 160
 - call semantics 31
 - data representation 32
 - described 24, 29, 30
 - identifying remote procedures 32, 225, 226, 228
 - information reporting 40, 135
- interface routines 32, 36, 77, 99
 - bottom level 35, 98, 99
 - caching servers 99
 - expert level 34, 93, 97
 - intermediate level 34, 90
 - low-level data structures 99
 - overview 32, 36, 77, 78, 86
 - simplified 33, 78, 86
 - standard 33, 36, 86
 - top level 33, 48, 86, 90
- library selection, rpcgen tool and 43, 56, 67
- name-to-address translation 38, 39, 160
- network selection 36
- protocol 223, 232
 - authentication and 226, 227
 - binding and rendezvous
 - independence and 31, 225
 - identifying procedures 32, 225, 226, 228
 - in XDR language 229, 232
 - overview 223, 225
 - record-marking standard 232
 - transport protocols and semantics
 - and 31, 224
 - version number 226
- raw, testing programs using
 - low-level 102, 104
- transient RPC program numbers 135, 136, 227
- transport selection 37
- transport types 36, 37
- TI-RPC (transport-independent remote procedure call), *see* arguments\x0d
 - parameter passing
- TI-RPC (transport-independent remote procedure call), *see* porting TS-RPC to TI-RPC\x0d
 - TS-RPC and
- TI-RPC (transport-independent remote procedure call), *see* rpcbind routine\x0d
 - address registration
- rpcgen tool
- time
 - obtaining current 164, 235, 258

- ping program 243, 244
- time server program 55, 67, 291
- time service
 - intermediate level client for 91, 92
 - intermediate level server for 92
 - rpcbind routine 164, 235, 258
 - top level client for 87, 89
 - top level server for 89, 90
- time synchronization
 - AUTH_DES authentication 115, 236
 - AUTH_KERB authentication 117, 242
 - NIS+ 179
- time-out periods
 - rpcgen tool and 69, 71
- time.x program 55, 67, 291
- timed client creation
 - intermediate level interface 34, 92
 - top level interface 34, 88
- timestamps, *see* time synchronization
- time_prog routine 90
- TLI (transport-level interface), *see* expert level interface routines
- TLI file descriptors
 - passing open 93, 96
- top level interface routines (RPC) 33, 48, 86, 90
 - client 48, 86, 89
 - overview 33, 86
 - server 89, 90
- transaction IDs 32, 225
- transaction log functions (NIS+) 175, 179
- transient program numbers 135, 136, 227
- translating, *see* converting
- transport
 - defined 336
- transport addresses (netbuf addresses) 258
- transport handles
 - defined 336
 - server 100
 - SVCXPRT service 130, 143
 - XDR routines requiring 86, 88
- transport protocols
 - RPC protocol and 224
- UDP (user datagram protocol)
- transport selection
 - RPC 37
 - rpcgen tool 69
- transport types

- described 36, 37
- interfaces and 86
- rpcgen tool and 69
- connectionless transports
- transport-independent remote procedure call, *see* TI-RPC
 - (transport-independent remote procedure call)
- transport-level interface (TLI) routines, *see* expert level interface routines
- transport-level interface file descriptors
 - passing open 93, 96
- transport-specific remote procedure call, *see* TS-RPC (transport-specific remote procedure call)
- trees 275
- TS-RPC (transport-specific remote procedure call)
 - library selection, rpcgen tool and 56, 67
- TS-RPC (transport-specific remote procedure call), *see* porting TS-RPC to TI-RPC
- porting to TI-RPC
- ttyadm command 311
- ttymon port monitor 311
- tutorials
 - rpcgen tool 43, 56
- type definitions
 - RPC language 246
 - XDR language 273, 274, 277

U

- UDP (user datagram protocol)
 - broadcast RPC and 106
 - client creation routines for 93, 96, 98
 - nettype parameter for 37
 - porting UDP applications from TS-RPC to TI-RPC 158
 - portmap port number for 304
 - RCP protocol and 224
 - rpcbind port number for 39, 256
 - server creation routines for 96 to 99
- udp transport type 37
- UDP/IP protocol, *see* UDP (user datagram protocol)

- ulimit command 323
- umask command 323
- unions
 - declarations
 - RPC language 51, 249
 - XDR language 272, 274, 277
 - XDR code samples 211, 213
- universal addresses 38, 257, 258, 301, 336
- unregistering
 - current vs. previous release 162
 - portmap routine 305
 - rpcbind routine 39, 254, 257
 - rpcinfo routine 40
- unsigned hyper integers
 - XDR language 265
- unsigned integers
 - XDR language 263
- user datagram protocol, , see UDP (user datagram protocol)\x0d
- User MT mode 141, 143, 146, 153
- user's bind address
 - passing 96
- users
 - number of
 - on a network 113, 114
 - on a remote host 78
- /usr/include/rpcsvc directory 228
- /usr/share/lib directory 54
- utmpx entries
 - creating 310, 317, 320

V

- /var/saf/_log file 333
- /var/saf/ directory 312, 316, 333
- variable declarations 247
- variable-length array declarations
 - RPC language 247
 - XDR language 271
- variable-length opaque data
 - XDR language 268, 269
- verifiers
 - AUTH_DES 235, 236, 238
 - AUTH_KERB 117, 118, 241, 242
 - AUTH_SYS 233, 234
 - described 226, 227
- version numbers
 - assigning 132

- changing 132
- described 32, 132, 226
- error conditions 226
- message protocol 226
- multiple client versions 134, 135
- multiple server versions 132, 133
- port monitors 317, 318
- registration of 132
- version numbers, see portmap routine
 - mapping
- versions
- version-lists
 - RPC language 245
- versions
 - library functions, compatibility of current
 - vs. previous release 161, 164
 - RPC language 245
- visible transport type 36
- void arguments 250
- void declarations
 - RPC language 251
 - XDR language 273

W

- window of credentials
 - AUTH_DES authentication 115, 237
 - AUTH_KERB authentication 117, 241
 - defined 236
 - window verifiers 236

X

- .x suffix 51
- XDR (external data representation) 195, 222
 - block size 262
 - canonical standard 199
 - converting from (deserializing) 82, 85, 90, 156, 157, 201, 335
 - converting to (serializing) 50, 54, 82, 86, 156, 158, 197, 198, 200, 201, 336
 - cost of conversion 199
 - described 24, 195, 198, 261
 - direction determination for
 - operations 215
 - direction independence of routines 201

- file data structure in 278
- graphic box notation 262
- library 200, 201
- linked lists 219, 222, 275
- memory allocation with 156, 158
- optimizing routines 215
- primitive routines 82, 86, 200, 202, 217
 - arrays 207, 210, 211
 - byte arrays 207
 - constructed (compound) data type
 - filters 85, 206
 - discriminated unions 211, 213
 - enumeration filters 205, 206
 - fixed-length arrays 211
 - floating point filters 82, 205
 - memory requirements 202, 204, 206
 - no-data routine 206
 - nonfilter 214
 - number filters 82, 84, 204, 205
 - opaque data 210, 211
 - overview 202
 - pointers 213, 214
 - strings 85, 206, 207
 - unions 211, 213
- remote copy (two-way XDR) routine 153, 156
- rpcgen tool and 50, 54, 55, 195
- streams
 - accessing 215
 - creation by RPC system 200
 - implementing new instances of 218, 219
 - interface to 218, 219
 - memory 216
 - nonfilter primitives for 214
 - record (TCP/IP) 216, 217, 232
 - standard I/O 215
- transport handles and 86, 88

XDR (external data representation), *see* XDR language\x0d

- protocol

XDR language 262, 278

- arrays 270, 271, 277
- AUTH_DES authentication protocol
 - in 236, 239
- booleans 264
- comments 275
- constants 273, 275, 277
- counted byte strings 269, 270
- declarations 262, 275
- discriminated unions 272, 274, 277
- enumerations 264
- file data structure described in 278
- fixed-length arrays 270
- fixed-length opaque data 268
- floating point 266, 267
- hyper integers 265
- identifiers 275
- integers 197, 198, 263, 265
- keywords 277
- opaque data 268, 269
- optional-data unions 274
- overview 261, 262, 337
- quadruple-precision floating point 267
- RPC language vs. 243, 244, 279
- RPC message protocol in 229, 232
- signed integers 263
- specification for 275, 278
- strings 269, 270
- structures 271, 277, 278
- syntax 277, 278
- type definitions 273, 274, 277
- unions 272, 274, 277
- unsigned hyper integers 265
- unsigned integers 263
- variable-length arrays 271
- variable-length opaque data 268, 269
- voids 273

- xdrmem_create routine 216
- xdrrec_create routine 216
- xdrrec_endofrecord routine 217
- xdrrec_eof routine 217
- xdrrec_skiprecord routine 217
- xdrs-x_op field 215
- xdrstdio_create routine 200, 215
- xdr_prefix 51
- xdr_array routine 208, 210, 213
- xdr_bool routine 82
- xdr_bytes routine 85, 207
- xdr_char routine 82, 205
- xdr_chararr routines 156, 157
- xdr_cnd routine 209
- XDR_DECODE operation 206
- xdr_destroy routine 215
- xdr_double routine 82, 205

xdr_element routine 208
XDR_ENCODE operation 206
xdr_enum routine 82
xdr_float routine 82, 205
XDR_FREE operation 206
xdr_free routine 54, 64
xdr_getpos routine 215
xdr_gnumbers routine 201, 219, 222
xdr_history routine 210
xdr_hyper routine 83
xdr_inline count 56, 68
xdr_int routine 82, 197, 198, 200, 205
xdr_int16 routine 83
xdr_int32 routine 83
xdr_int64 routine 83
xdr_int8 routine 83
xdr_long routine 28
xdr_netobj routine 82, 210
xdr_opaque routine 210
xdr_party routine 209
xdr_pgn routine 214
xdr_pointer routine 214, 221, 222
xdr_quadruple routine 82
xdr_rcp routine 153, 156, 165
xdr_reference routine 85, 213, 214, 222
xdr_setpos routine 215
xdr_short routine 82
xdr_simple routine 83, 86
xdr_sizeof routine 202, 204
xdr_string routine 83, 85, 206, 209, 210
xdr_type(object) notation 117
xdr_union routine 211, 213
xdr_u_char routine 82, 205
xdr_u_int routine 82, 205
xdr_u_long routine 82
xdr_u_short routine 82
xdr_varintarr routine 84
xdr_vector routine 85, 211
xdr_void routine 82, 206
xdr_wrapstring routine 82, 209, 210
xpvt_register routine 163
xpvt_unregister routine 163
xp_fd field 101
xp_ltaddr field 101
xp_netid field 101
xp_rtaddr field 101
xp_tp field 101
x_base field 219
x_destroy macro 219
x_getbytes routine 219
x_getint routine 219
x_getint32 routine 219
x_getlong routine 219
x_getpostn macro 219
x_handy field 219
x_inline routine 219
x_op field 219
x_private field 219
x_public field 219
x_putbytes routine 219
x_putint routine 219
x_putint32 routine 219
x_putlong routine 219
x_setpostn macro 219